

# Configuration Guide



## Gigabit Ethernet L3 Stackable Managed Switch with 10GbE Uplink

▶ SGS-6341 Series



## Trademarks

Copyright © PLANET Technology Corp. 2017.

Contents are subject to revision without prior notice.

PLANET is a registered trademark of PLANET Technology Corp. All other trademarks belong to their respective owners.

## Disclaimer

PLANET Technology does not warrant that the hardware will work properly in all environments and applications, and makes no warranty and representation, either implied or expressed, with respect to the quality, performance, merchantability, or fitness for a particular purpose. PLANET has made every effort to ensure that this User's Manual is accurate; PLANET disclaims liability for any inaccuracies or omissions that may have occurred.

Information in this User's Manual is subject to change without notice and does not represent a commitment on the part of PLANET. PLANET assumes no responsibility for any inaccuracies that may be contained in this User's Manual. PLANET makes no commitment to update or keep current the information in this User's Manual, and reserves the right to make improvements to this User's Manual and/or to the products described in this User's Manual, at any time without notice.

If you find information in this manual that is incorrect, misleading, or incomplete, we would appreciate your comments and suggestions.

## FCC Warning

This equipment has been tested and found to comply with the limits for a Class A digital device, pursuant to Part 15 of the FCC Rules. These limits are designed to provide reasonable protection against harmful interference when the equipment is operated in a commercial environment. This equipment generates, uses, and can radiate radio frequency energy and, if not installed and used in accordance with the Instruction manual, may cause harmful interference to radio communications. Operation of this equipment in a residential area is likely to cause harmful interference in which case the user will be required to correct the interference at whose own expense.

## CE Mark Warning

This is a Class A product. In a domestic environment, this product may cause radio interference, in which case the user may be required to take adequate measures.

## WEEE Warning



To avoid the potential effects on the environment and human health as a result of the presence of hazardous substances in electrical and electronic equipment, end users of electrical and electronic equipment should understand the meaning of the crossed-out wheeled bin symbol. Do not dispose of WEEE as unsorted municipal waste and have to collect such WEEE separately.

## Energy Saving Note of the Device

This power required device does not support Standby mode operation.

For energy saving, please remove the power cable to disconnect the device from the power circuit.

Without removing power cable, the device will still consuming power from the power source. In the view of Saving the Energy and reduce the unnecessary power consuming, it is strongly suggested to remove the power connection for the device if this device is not intended to be active.

## Revision

User's Manual of PLANET 24-Port Gigabit Layer 3 Stackable Managed Switch with 4 10G Slots

Models: SGS-6341-24T4X, SGS-6341-24P4X and SGS-6341-48T4X

Revision: 2.0 (November, 2017)

Part No: EM-SGS-6341 Series Configuration Guide\_v2.0

# Contents

<b>CHAPTER 1 INTRODUCTION .....</b>	<b>1-20</b>
<b>1.1 PACKET CONTENTS .....</b>	<b>1-20</b>
<b>1.2 PRODUCT DESCRIPTION .....</b>	<b>1-21</b>
<b>1.3 PRODUCT FEATURES .....</b>	<b>1-25</b>
<b>1.4 PRODUCT SPECIFICATIONS.....</b>	<b>1-28</b>
<b>CHAPTER 2 INSTALLATION.....</b>	<b>2-32</b>
<b>2.1 HARDWARE DESCRIPTION .....</b>	<b>2-32</b>
2.1.1 Switch Front Panel .....	2-32
2.1.2 LED Indications .....	2-33
2.1.3 Switch Rear Panel.....	2-35
<b>2.2 SWITCH INSTALLATION .....</b>	<b>2-36</b>
2.2.1 Desktop Installation .....	2-36
2.2.2 Rack Mounting .....	2-37
2.2.3 Installing the SFP/SFP+ Transceiver .....	2-38
<b>CHAPTER 3 SWITCH MANAGEMENT .....</b>	<b>3-42</b>
<b>3.1 MANAGEMENT OPTIONS.....</b>	<b>3-42</b>
3.1.1 Out-Of-Band Management.....	3-42
3.1.2 In-band Management .....	3-45
<b>3.2 CLI INTERFACE.....</b>	<b>3-52</b>
3.2.1 Configuration Modes .....	3-52
3.2.2 Configuration Syntax.....	3-54
3.2.3 Shortcut Key Support .....	3-56
3.2.4 Help Function .....	3-56
3.2.5 Input Verification.....	3-57
3.2.6 Fuzzy Match Support .....	3-57
<b>CHAPTER 4 BASIC SWITCH CONFIGURATION .....</b>	<b>4-1</b>
<b>4.1 BASIC CONFIGURATION.....</b>	<b>4-1</b>
<b>4.2 TELNET MANAGEMENT.....</b>	<b>4-2</b>
4.2.1 Telnet .....	4-2
4.2.2 SSH.....	4-3
<b>4.3 CONFIGURATION OF SWITCH IP ADDRESSES .....</b>	<b>4-5</b>
4.3.1 Switch IP Addresses Configuration Task List.....	4-5
<b>4.4 SNMP CONFIGURATION .....</b>	<b>4-6</b>
4.4.1 Introduction to SNMP .....	4-6
4.4.2 Introduction to MIB .....	4-7
4.4.3 Introduction to RMON .....	4-8

4.4.4 SNMP Configuration .....	4-9
4.4.5 Typical SNMP Configuration Examples .....	4-11
4.4.6 SNMP Troubleshooting .....	4-13
<b>4.5 SWITCH UPGRADE .....</b>	<b>4-13</b>
4.5.1 Switch System Files .....	4-13
4.5.2 BootROM Upgrade.....	4-14
4.5.3 FTP/TFTP Upgrade.....	4-17
<b>CHAPTER 5 FILE SYSTEM OPERATIONS.....</b>	<b>5-1</b>
5.1 INTRODUCTION TO FILE STORAGE DEVICES.....	5-1
5.2 FILE SYSTEM OPERATION CONFIGURATION TASK LIST .....	5-1
5.3 TYPICAL APPLICATIONS.....	5-2
5.4 TROUBLESHOOTING .....	5-3
<b>CHAPTER 6 CLUSTER CONFIGURATION.....</b>	<b>6-1</b>
6.1 INTRODUCTION TO CLUSTER NETWORK MANAGEMENT.....	6-1
6.2 CLUSTER NETWORK MANAGEMENT CONFIGURATION SEQUENCE.....	6-1
6.3 EXAMPLES OF CLUSTER ADMINISTRATION .....	6-5
6.4 CLUSTER ADMINISTRATION TROUBLESHOOTING.....	6-5
<b>CHAPTER 7 PORT CONFIGURATION.....</b>	<b>7-1</b>
7.1 INTRODUCTION TO PORT .....	7-1
7.2 NETWORK PORT CONFIGURATION TASK LIST .....	7-1
7.3 PORT CONFIGURATION EXAMPLE .....	7-3
7.4 PORT TROUBLESHOOTING.....	7-4
<b>CHAPTER 8 PORT ISOLATION FUNCTION CONFIGURATION.....</b>	<b>8-1</b>
8.1 INTRODUCTION TO PORT ISOLATION FUNCTION.....	8-1
8.2 TASK SEQUENCE OF PORT ISOLATION.....	8-1
8.3 PORT ISOLATION FUNCTION TYPICAL EXAMPLES.....	8-2
<b>CHAPTER 9 PORT LOOPBACK DETECTION FUNCTION CONFIGURATION .....</b>	<b>9-4</b>
9.1 INTRODUCTION TO PORT LOOPBACK DETECTION FUNCTION .....	9-4
9.2 PORT LOOPBACK DETECTION FUNCTION CONFIGURATION TASK LIST .....	9-4
9.3 PORT LOOPBACK DETECTION FUNCTION EXAMPLE .....	9-6
9.4 PORT LOOPBACK DETECTION TROUBLESHOOTING.....	9-7
<b>CHAPTER 10 ULDP FUNCTION CONFIGURATION .....</b>	<b>10-1</b>
10.1 INTRODUCTION TO ULDP FUNCTION.....	10-1



10.2 ULDP CONFIGURATION TASK SEQUENCE .....	10-2
10.3 ULDP FUNCTION TYPICAL EXAMPLES .....	10-5
10.4 ULDP TROUBLESHOOTING .....	10-6
<b>CHAPTER 11 LLDP FUNCTION OPERATION CONFIGURATION .....</b>	<b>11-1</b>
11.1 INTRODUCTION TO LLDP FUNCTION .....	11-1
11.2 LLDP FUNCTION CONFIGURATION TASK SEQUENCE .....	11-2
11.3 LLDP FUNCTION TYPICAL EXAMPLE.....	11-5
11.4 LLDP FUNCTION TROUBLESHOOTING.....	11-5
<b>CHAPTER 12 PORT CHANNEL CONFIGURATION .....</b>	<b>12-1</b>
12.1 INTRODUCTION TO PORT CHANNEL.....	12-1
12.2 BRIEF INTRODUCTION TO LACP .....	12-2
12.2.1 Static LACP Aggregation.....	12-3
12.2.2 Dynamic LACP Aggregation.....	12-3
12.3 PORT CHANNEL CONFIGURATION TASK LIST.....	12-3
12.4 PORT CHANNEL EXAMPLES.....	12-5
12.5 PORT CHANNEL TROUBLESHOOTING .....	12-8
<b>CHAPTER 13 JUMBO CONFIGURATION.....</b>	<b>13-1</b>
13.1 INTRODUCTION TO JUMBO .....	13-1
13.2 JUMBO CONFIGURATION TASK SEQUENCE .....	13-1
<b>CHAPTER 14 EFM OAM CONFIGURATION.....</b>	<b>14-2</b>
14.1 INTRODUCTION TO EFM OAM .....	14-2
14.2 EFM OAM CONFIGURATION .....	14-4
14.3 EFM OAM EXAMPLE.....	14-7
14.4 EFM OAM TROUBLESHOOTING .....	14-8
<b>CHAPTER 15 VLAN CONFIGURATION .....</b>	<b>15-9</b>
15.1 VLAN CONFIGURATION .....	15-9
15.1.1 Introduction to VLAN.....	15-9
15.1.2 VLAN Configuration Task List .....	15-10
15.1.3 Typical VLAN Application .....	15-13
15.1.4 Typical Application of Hybrid Port.....	15-15
15.2 GVRP CONFIGURATION .....	15-17
15.2.1 Introduction to GVRP .....	15-17
15.2.2 GVRP Configuration Task List.....	15-18
15.2.3 Example of GVRP .....	15-19
15.2.4 GVRP Troubleshooting .....	15-20

<b>15.3 DOT1Q-TUNNEL CONFIGURATION .....</b>	<b>15-21</b>
15.3.1 Introduction to Dot1q-tunnel.....	15-21
15.3.2 Dot1q-tunnel Configuration .....	15-22
15.3.3 Typical Applications of the Dot1q-tunnel .....	15-22
15.3.4 Dot1q-tunnel Troubleshooting .....	15-23
<b>15.4 VLAN-TRANSLATION CONFIGURATION.....</b>	<b>15-24</b>
15.4.1 Introduction to VLAN-translation .....	15-24
15.4.2 VLAN-translation Configuration .....	15-24
15.4.3 Typical application of VLAN-translation .....	15-25
15.4.4 VLAN-translation Troubleshooting .....	15-26
<b>15.5 DYNAMIC VLAN CONFIGURATION.....</b>	<b>15-26</b>
15.5.1 Introduction to Dynamic VLAN.....	15-26
15.5.2 Dynamic VLAN Configuration .....	15-27
15.5.3 Typical Application of the Dynamic VLAN .....	15-28
15.5.4 Dynamic VLAN Troubleshooting .....	15-30
<b>15.6 VOICE VLAN CONFIGURATION .....</b>	<b>15-30</b>
15.6.1 Introduction to Voice VLAN .....	15-30
15.6.2 Voice VLAN Configuration.....	15-31
15.6.3 Typical Applications of the Voice VLAN .....	15-32
15.6.4 Voice VLAN Troubleshooting .....	15-33
<b>CHAPTER 16 MAC TABLE CONFIGURATION.....</b>	<b>16-34</b>
<b>16.1 INTRODUCTION TO MAC TABLE .....</b>	<b>16-34</b>
16.1.1 Obtaining MAC Table .....	16-34
16.1.2 Forward or Filter .....	16-35
<b>16.2 MAC ADDRESS TABLE CONFIGURATION TASK LIST.....</b>	<b>16-36</b>
<b>16.3 TYPICAL CONFIGURATION EXAMPLES .....</b>	<b>16-37</b>
<b>16.4 MAC TABLE TROUBLESHOOTING .....</b>	<b>16-38</b>
<b>16.5 MAC ADDRESS FUNCTION EXTENSION.....</b>	<b>16-38</b>
16.5.1 MAC Address Binding .....	16-38
<b>CHAPTER 17 MSTP CONFIGURATION.....</b>	<b>17-1</b>
<b>17.1 INTRODUCTION TO MSTP .....</b>	<b>17-1</b>
17.1.1 MSTP Region .....	17-1
17.1.2 Port Roles.....	17-3
17.1.3 MSTP Load Balance .....	17-3
<b>17.2 MSTP CONFIGURATION TASK LIST.....</b>	<b>17-3</b>
<b>17.3 MSTP EXAMPLE.....</b>	<b>17-8</b>
<b>17.4 MSTP TROUBLESHOOTING .....</b>	<b>17-12</b>
<b>CHAPTER 18 QOS CONFIGURATION.....</b>	<b>18-1</b>
<b>18.1 INTRODUCTION TO QoS .....</b>	<b>18-1</b>

18.1.1 QoS Terms .....	18-1
18.1.2 QoS Implementation .....	18-2
18.1.3 Basic QoS Model .....	18-3
<b>18.2 QoS CONFIGURATION TASK LIST .....</b>	<b>18-7</b>
<b>18.3 QoS EXAMPLE .....</b>	<b>18-11</b>
<b>18.4 QoS TROUBLESHOOTING.....</b>	<b>18-13</b>
<b>CHAPTER 19 FLOW-BASED REDIRECTION.....</b>	<b>19-14</b>
19.1 INTRODUCTION TO FLOW-BASED REDIRECTION .....	19-14
19.2 FLOW-BASED REDIRECTION CONFIGURATION TASK SEQUENCE .....	19-14
19.3 FLOW-BASED REDIRECTION EXAMPLES .....	19-15
19.4 FLOW-BASED REDIRECTION TROUBLESHOOTING HELP.....	19-15
<b>CHAPTER 20 EGRESS QOS CONFIGURATION.....</b>	<b>20-16</b>
20.1 INTRODUCTION TO EGRESS QoS .....	20-16
20.1.1 Egress QoS Terms .....	20-16
20.1.2 Basic Egress QoS Model .....	20-17
20.2 EGRESS QoS CONFIGURATION .....	20-18
20.3 EGRESS QoS EXAMPLES.....	20-21
20.4 EGRESS QoS EXAMPLES.....	20-23
<b>CHAPTER 21 FLEXIBLE Q-IN-Q CONFIGURATION.....</b>	<b>21-24</b>
21.1 INTRODUCTION TO FLEXIBLE Q-IN-Q.....	21-24
21.1.1 Q-in-Q Technique .....	21-24
21.1.2 Basic Q-in-Q.....	21-24
21.1.3 Flexible Q-in-Q .....	21-24
21.2 FLEXIBLE Q-IN-Q CONFIGURATION TASK LIST.....	21-24
21.3 FLEXIBLE Q-IN-Q EXAMPLE .....	21-26
21.4 FLEXIBLE Q-IN-Q TROUBLESHOOTING .....	21-28
<b>CHAPTER 22 LAYER 3 FORWARD CONFIGURATION .....</b>	<b>22-29</b>
22.1 LAYER 3 INTERFACE.....	22-29
22.1.1 Introduction to Layer 3 Interface .....	22-29
22.1.2 Layer 3 Interface Configuration Task List.....	22-29
22.2 IP CONFIGURATION .....	22-31
22.2.1 Introduction to IPv4, IPv6 .....	22-31
22.2.2 IP Configuration.....	22-33
22.2.3 IP Configuration Examples.....	22-39
22.2.4 IP Configuration Examples.....	22-44
22.3 IP FORWARDING .....	22-44

22.3.1 Introduction to IP Forwarding .....	22-44
22.3.2 IP Route Aggregation Configuration Task .....	22-44
<b>22.4 URPF .....</b>	<b>22-44</b>
22.4.1 Introduction to URPF.....	22-44
22.4.2 URPF Configuration Task Sequence .....	22-45
22.4.3 URPF Typical Example .....	22-46
22.4.4 URPF Troubleshooting.....	22-46
<b>22.5 ARP .....</b>	<b>22-46</b>
22.5.1 Introduction to ARP .....	22-46
22.5.2 ARP Configuration Task List.....	22-47
22.5.3 ARP Troubleshooting .....	22-48
<b>22.6 HARDWARE TUNNEL CAPACITY CONFIGURATION.....</b>	<b>22-48</b>
22.6.1 Introduction to Hardware Tunnel Capacity .....	22-48
22.6.2 Hardware Tunnel Capacity Configuration .....	22-48
22.6.3 Hardware Tunnel Capacity Troubleshooting .....	22-48
<b>CHAPTER 23 ARP SCANNING PREVENTION FUNCTION CONFIGURATION .....</b>	<b>23-49</b>
23.1 INTRODUCTION TO ARP SCANNING PREVENTION FUNCTION .....	23-49
23.2 ARP SCANNING PREVENTION CONFIGURATION TASK SEQUENCE .....	23-49
23.3 ARP SCANNING PREVENTION TYPICAL EXAMPLES.....	23-51
23.4 ARP SCANNING PREVENTION TROUBLESHOOTING HELP.....	23-52
<b>CHAPTER 24 PREVENT ARP, ND SPOOFING CONFIGURATION.....</b>	<b>24-53</b>
24.1 OVERVIEW.....	24-53
24.1.1 ARP (Address Resolution Protocol) .....	24-53
24.1.2 ARP Spoofing.....	24-53
24.1.3 How to prevent void ARP/ND Spoofing.....	24-53
24.2 PREVENT ARP, ND SPOOFING CONFIGURATION .....	24-54
24.3 PREVENT ARP, ND SPOOFING EXAMPLE .....	24-55
<b>CHAPTER 25 ARP GUARD CONFIGURATION .....</b>	<b>25-57</b>
25.1 INTRODUCTION TO ARP GUARD .....	25-57
25.2 ARP GUARD CONFIGURATION TASK LIST .....	25-58
<b>CHAPTER 26 ARP LOCAL PROXY CONFIGURATION.....</b>	<b>26-59</b>
26.1 INTRODUCTION TO ARP LOCAL PROXY FUNCTION .....	26-59
26.2 ARP LOCAL PROXY FUNCTION CONFIGURATION TASK LIST.....	26-60
26.3 TYPICAL EXAMPLES OF ARP LOCAL PROXY FUNCTION .....	26-60
26.4 ARP LOCAL PROXY FUNCTION TROUBLESHOOTING.....	26-61
<b>CHAPTER 27 GRATUITOUS ARP CONFIGURATION .....</b>	<b>27-62</b>

27.1 INTRODUCTION TO GRATUITOUS ARP .....	27-62
27.2 GRATUITOUS ARP CONFIGURATION TASK LIST .....	27-62
27.3 GRATUITOUS ARP CONFIGURATION EXAMPLE .....	27-63
27.4 GRATUITOUS ARP TROUBLESHOOTING .....	27-63
<b>CHAPTER 28 KEEPALIVE GATEWAY CONFIGURATION .....</b>	<b>28-64</b>
28.1 INTRODUCTION TO KEEPALIVE GATEWAY.....	28-64
28.2 KEEPALIVE GATEWAY CONFIGURATION TASK LIST.....	28-64
28.3 KEEPALIVE GATEWAY EXAMPLE .....	28-65
28.4 KEEPALIVE GATEWAY TROUBLESHOOTING .....	28-66
<b>CHAPTER 29 DHCP CONFIGURATION .....</b>	<b>29-67</b>
29.1 INTRODUCTION TO DHCP.....	29-67
29.2 DHCP SERVER CONFIGURATION .....	29-68
29.3 DHCP RELAY CONFIGURATION .....	29-70
29.4 DHCP CONFIGURATION EXAMPLES.....	29-71
29.5 DHCP TROUBLESHOOTING .....	29-73
<b>CHAPTER 30 DHCPV6 CONFIGURATION .....</b>	<b>30-1</b>
30.1 INTRODUCTION TO DHCPV6.....	30-1
30.2 DHCPV6 SERVER CONFIGURATION .....	30-2
30.3 DHCPV6 RELAY DELEGATION CONFIGURATION .....	30-3
30.4 DHCPV6 PREFIX DELEGATION SERVER CONFIGURATION .....	30-4
30.5 DHCPV6 PREFIX DELEGATION CLIENT CONFIGURATION .....	30-6
30.6 DHCPV6 CONFIGURATION EXAMPLES.....	30-6
30.7 DHCPV6 TROUBLESHOOTING .....	30-10
<b>CHAPTER 31 DHCP OPTION 82 CONFIGURATION.....</b>	<b>31-1</b>
31.1 INTRODUCTION TO DHCP OPTION 82 .....	31-1
31.1.1 DHCP option 82 Message Structure .....	31-1
31.1.2 option 82 Working Mechanism.....	31-2
31.2 DHCP OPTION 82 CONFIGURATION TASK LIST .....	31-2
31.3 DHCP OPTION 82 APPLICATION EXAMPLES .....	31-6
31.4 DHCP OPTION 82 TROUBLESHOOTING .....	31-7
<b>CHAPTER 32 DHCPV6 OPTION37, 38 .....</b>	<b>32-9</b>
32.1 INTRODUCTION TO DHCPV6 OPTION37, 38.....	32-9
32.2 DHCPV6 OPTION37, 38 CONFIGURATION TASK LIST.....	32-9

32.3 DHCPV6 OPTION37, 38 EXAMPLES.....	32-14
32.3.1 DHCPv6 Snooping option37, 38 Example .....	32-14
32.3.2 DHCPv6 Snooping option37, 38 Example .....	32-15
32.4 DHCPV6 OPTION37, 38 TROUBLESHOOTING .....	32-16
<b>CHAPTER 33 DHCP SNOOPING CONFIGURATION .....</b>	<b>33-1</b>
33.1 INTRODUCTION TO DHCP SNOOPING.....	33-1
33.2 DHCP SNOOPING CONFIGURATION TASK SEQUENCE.....	33-2
33.3 DHCP SNOOPING TYPICAL APPLICATION.....	33-6
33.4 DHCP SNOOPING TROUBLESHOOTING HELP .....	33-7
33.4.1 Monitor and Debug Information .....	33-7
33.4.2 DHCP Snooping Troubleshooting Help.....	33-7
33.5 DHCPV6 SNOOPING TYPICAL APPLICATION .....	33-1
33.6 DHCPV6 SNOOPING TROUBLESHOOTING .....	33-2
33.6.1 Monitor and Debug Information .....	33-2
33.6.2 DHCPv6 Snooping Troubleshooting Help.....	33-2
<b>CHAPTER 34 ROUTING PROTOCOL OVERVIEW .....</b>	<b>34-1</b>
34.1 ROUTING TABLE .....	34-1
34.2 IP ROUTING POLICY.....	34-2
34.2.1 Introduction to Routing Policy .....	34-2
34.2.2 IP Routing Policy Configuration Task List .....	34-4
34.2.3 Configuration Examples .....	34-7
34.2.4 Troubleshooting.....	34-8
<b>CHAPTER 35 STATIC ROUTE.....</b>	<b>35-1</b>
35.1 INTRODUCTION TO STATIC ROUTE .....	35-1
35.2 INTRODUCTION TO DEFAULT ROUTE.....	35-1
35.3 STATIC ROUTE CONFIGURATION TASK LIST .....	35-1
35.4 STATIC ROUTE CONFIGURATION EXAMPLES .....	35-2
<b>CHAPTER 36 RIP .....</b>	<b>36-1</b>
36.1 INTRODUCTION TO RIP .....	36-1
36.2 RIP CONFIGURATION TASK LIST .....	36-2
36.3 RIP EXAMPLES.....	36-9
36.3.1 Typical RIP Examples .....	36-9
36.3.2 Typical Examples of RIP aggregation function .....	36-11
36.4 RIP TROUBLESHOOTING .....	36-12
<b>CHAPTER 37 RIPNG .....</b>	<b>37-1</b>

37.1 INTRODUCTION TO RIPNG .....	37-1
37.2 RIPNG CONFIGURATION TASK LIST.....	37-2
37.3 RIPNG CONFIGURATION EXAMPLES.....	37-7
37.3.1 Typical RIPng Examples .....	37-7
37.3.2 RIPng Aggregation Route Function Typical Examples .....	37-8
37.4 RIPNG TROUBLESHOOTING.....	37-9
<b>CHAPTER 38 OSPF .....</b>	<b>38-1</b>
38.1 INTRODUCTION TO OSPF .....	38-1
38.2 OSPF CONFIGURATION TASK LIST .....	38-4
38.3 OSPF EXAMPLES.....	38-8
38.3.1 Configuration Example of OSPF .....	38-8
38.3.2 Configuration Examples of OSPF VPN.....	38-17
38.4 OSPF TROUBLESHOOTING .....	38-19
<b>CHAPTER 39 OSPFV3 .....</b>	<b>39-1</b>
39.1 INTRODUCTION TO OSPFV3 .....	39-1
39.2 OSPFV3 CONFIGURATION TASK LIST .....	39-4
39.3 OSPFV3 EXAMPLES.....	39-8
39.4 OSPFV3 TROUBLESHOOTING .....	39-11
<b>CHAPTER 40 BGP .....</b>	<b>40-1</b>
40.1 INTRODUCTION TO BGP .....	40-1
40.2 BGP CONFIGURATION TASK LIST .....	40-4
40.3 CONFIGURATION EXAMPLES OF BGP .....	40-17
40.3.1 Examples 1: configure BGP neighbor .....	40-17
40.3.2 Examples 2: configure BGP aggregation .....	40-18
40.3.3 Examples 3: configure BGP community attributes.....	40-18
40.3.4 Examples 4: configure BGP confederation .....	40-20
40.3.5 Examples 5: configure BGP route reflector.....	40-21
40.3.6 Examples 6: configure MED of BGP .....	40-23
40.3.7 Examples 7: example of BGP VPN.....	40-25
40.4 BGP TROUBLESHOOTING .....	40-29
<b>CHAPTER 41 MBGP4+.....</b>	<b>41-1</b>
41.1 INTRODUCTION TO MBGP4+.....	41-1
41.2 MBGP4+ CONFIGURATION TASK LIST.....	41-1
41.3 MBGP4+ EXAMPLES.....	41-2
41.4 MBGP4+ TROUBLESHOOTING .....	41-4



<b>CHAPTER 42 BLACK HOLE ROUTING MANUAL .....</b>	<b>42-1</b>
42.1 INTRODUCTION TO BLACK HOLE ROUTING .....	42-1
42.2 IPV4 BLACK HOLE ROUTING CONFIGURATION TASK .....	42-1
42.3 IPV6 BLACK HOLE ROUTING CONFIGURATION TASK .....	42-1
42.4 BLACK HOLE ROUTING CONFIGURATION EXAMPLES .....	42-2
42.5 BLACK HOLE ROUTING TROUBLESHOOTING .....	42-3
<b>CHAPTER 43 GRE TUNNEL CONFIGURATION .....</b>	<b>43-5</b>
43.1 INTRODUCTION TO GRE TUNNEL .....	43-5
43.2 GRE TUNNEL BASIC CONFIGURATION .....	43-5
43.3 EXAMPLE OF GRE TUNNEL .....	43-7
43.4 EXAMPLE OF GRE TUNNEL QUOTES LOOPBACK GROUP.....	43-11
43.5 GRE TUNNEL TROUBLESHOOTING .....	43-16
<b>CHAPTER 44 ECMP CONFIGURATION .....</b>	<b>44-1</b>
44.1 INTRODUCTION TO ECMP .....	44-1
44.2 ECMP CONFIGURATION TASK LIST .....	44-1
44.3 ECMP TYPICAL EXAMPLE.....	44-2
44.3.1 Static Route Implements ECMP.....	44-2
44.3.2 OSPF Implements ECMP .....	44-3
44.4 ECMP TROUBLESHOOTING.....	44-4
<b>CHAPTER 45 BFD .....</b>	<b>45-5</b>
45.1 INTRODUCTION TO BFD .....	45-5
45.2 BFD CONFIGURATION TASK LIST .....	45-5
45.3 EXAMPLES OF BFD .....	45-7
45.3.1 Example for Linkage of BFD and Static Route .....	45-7
45.3.2 Example for Linkage of BFD and RIP Route .....	45-8
45.3.3 Example for Linkage of BFD and VRRP.....	45-9
45.4 BFD TROUBLESHOOTING.....	45-10
<b>CHAPTER 46 BGP GR .....</b>	<b>46-11</b>
46.1 INTRODUCTION TO GR .....	46-11
46.2 GR CONFIGURATION TASK LIST .....	46-12
46.3 TYPICAL EXAMPLE OF GR.....	46-14
<b>CHAPTER 47 OSPF GR .....</b>	<b>47-16</b>
47.1 INTRODUCTION TO OSPF GR.....	47-16
47.2 OSPF GR CONFIGURATION .....	47-17

47.3 OSPF GR EXAMPLE .....	47-18
47.4 OSPF GR TROUBLESHOOTING .....	47-19
<b>CHAPTER 48 IPV4 MULTICAST PROTOCOL .....</b>	<b>48-1</b>
<b>48.1 IPV4 MULTICAST PROTOCOL OVERVIEW .....</b>	<b>48-1</b>
48.1.1 Introduction to Multicast .....	48-1
48.1.2 Multicast Address .....	48-1
48.1.3 IP Multicast Packet Transmission .....	48-3
48.1.4 IP Multicast Application .....	48-3
<b>48.2 PIM-DM.....</b>	<b>48-3</b>
48.2.1 Introduction to PIM-DM .....	48-3
48.2.2 PIM-DM Configuration Task List.....	48-5
48.2.3 PIM-DM Configuration Examples.....	48-7
48.2.4 PIM-DM Troubleshooting .....	48-8
<b>48.3 PIM-SM.....</b>	<b>48-8</b>
48.3.1 Introduction to PIM-SM .....	48-8
48.3.2 PIM-SM Configuration Task List.....	48-9
48.3.3 PIM-SM Configuration Examples .....	48-13
48.3.4 PIM-SM Troubleshooting.....	48-15
<b>48.4 MSDP CONFIGURATION .....</b>	<b>48-15</b>
48.4.1 Introduction to MSDP .....	48-15
48.4.2 Brief Introduction to MSDP Configuration Tasks.....	48-16
48.4.3 Configuration of MSDP Basic Function.....	48-16
48.4.4 Configuration of MSDP Entities.....	48-18
48.4.5 Configuration of Delivery of MSDP Packet .....	48-18
48.4.6 Configuration of Parameters of SA-cache .....	48-19
48.4.7 MSDP Configuration Examples.....	48-19
48.4.8 MSDP Troubleshooting .....	48-25
<b>48.5 ANYCAST RP CONFIGURATION .....</b>	<b>48-25</b>
48.5.1 Introduction to ANYCAST RP.....	48-25
48.5.2 ANYCAST RP Configuration Task.....	48-26
48.5.3 ANYCAST RP Configuration Examples .....	48-28
48.5.4 ANYCAST RP Troubleshooting.....	48-29
<b>48.6 PIM-SSM .....</b>	<b>48-30</b>
48.6.1 Introduction to PIM-SSM .....	48-30
48.6.2 PIM-SSM Configuration Task List .....	48-30
48.6.3 PIM-SSM Configuration Examples .....	48-30
48.6.4 PIM-SSM Troubleshooting .....	48-32
<b>48.7 DVMRP.....</b>	<b>48-33</b>
48.7.1 Introduction to DVMRP .....	48-33
48.7.2 DVMRP Configuration Task List.....	48-34
48.7.3 DVMRP Configuration Examples .....	48-36
48.7.4 DVMRP Troubleshooting.....	48-36

<b>48.8 DCSCM</b> .....	<b>48-37</b>
48.8.1 Introduction to DCSCM .....	48-37
48.8.2 DCSCM Configuration Task List.....	48-38
48.8.3 DCSCM Configuration Examples.....	48-40
48.8.4 DCSCM Troubleshooting .....	48-41
<b>48.9 IGMP</b> .....	<b>48-41</b>
48.9.1 Introduction to IGMP .....	48-41
48.9.2 IGMP Configuration Task List.....	48-43
48.9.3 IGMP Configuration Examples.....	48-45
48.9.4 IGMP Troubleshooting .....	48-46
<b>48.10 IGMP SNOOPING</b> .....	<b>48-46</b>
48.10.1 Introduction to IGMP Snooping .....	48-46
48.10.2 IGMP Snooping Configuration Task List .....	48-47
48.10.3 IGMP Snooping Examples .....	48-49
48.10.4 IGMP Snooping Troubleshooting .....	48-51
<b>48.11 IGMP PROXY CONFIGURATION</b> .....	<b>48-52</b>
48.11.1 Introduction to IGMP Proxy .....	48-52
48.11.2 IGMP Proxy Configuration Task List.....	48-52
48.11.3 IGMP Proxy Examples .....	48-54
48.11.4 IGMP Proxy Troubleshooting .....	48-56
<b>CHAPTER 49 IPV6 MULTICAST PROTOCOL</b> .....	<b>49-1</b>
<b>49.1 PIM-DM6</b> .....	<b>49-1</b>
49.1.1 Introduction to PIM-DM6 .....	49-1
49.1.2 PIM-DM6 Configuration Task List.....	49-2
49.1.3 PIM-DM6 Typical Application .....	49-4
49.1.4 PIM-DM6 Troubleshooting .....	49-5
<b>49.2 PIM-SM6</b> .....	<b>49-5</b>
49.2.1 Introduction to PIM-SM6 .....	49-5
49.2.2 PIM-SM6 Configuration Task List.....	49-7
49.2.3 PIM-SM6 Typical Application.....	49-10
49.2.4 PIM-SM6 Troubleshooting.....	49-12
<b>49.3 ANYCAST RP v6 CONFIGURATION</b> .....	<b>49-13</b>
49.3.1 Introduction to ANYCAST RP v6.....	49-13
49.3.2 ANYCAST RP v6 Configuration Task.....	49-13
49.3.3 ANYCAST RP v6 Configuration Examples .....	49-16
49.3.4 ANYCAST RP v6 Troubleshooting .....	49-17
<b>49.4 PIM-SSM6</b> .....	<b>49-17</b>
49.4.1 Introduction to PIM-SSM6 .....	49-17
49.4.2 PIM-SSM6 Configuration Task List .....	49-18
49.4.3 PIM-SSM6 Configuration Example .....	49-18
49.4.4 PIM-SSM6 Troubleshooting .....	49-20
<b>49.5 IPv6 DCSCM</b> .....	<b>49-20</b>

49.5.1 Introduction to IPv6 DCSCM.....	49-20
49.5.2 IPv6 DCSCM Configuration Task Sequence.....	49-21
49.5.3 IPv6 DCSCM Typical Examples.....	49-23
49.5.4 IPv6 DCSCM Troubleshooting.....	49-24
<b>49.6 MLD.....</b>	<b>49-24</b>
49.6.1 Introduction to MLD.....	49-24
49.6.2 MLD Configuration Task List.....	49-25
49.6.3 MLD Typical Application.....	49-26
49.6.4 MLD Troubleshooting Help.....	49-27
<b>49.7 MLD SNOOPING.....</b>	<b>49-28</b>
49.7.1 Introduction to MLD Snooping.....	49-28
49.7.2 MLD Snooping Configuration Task.....	49-28
49.7.3 MLD Snooping Examples.....	49-30
49.7.4 MLD Snooping Troubleshooting.....	49-32
<b>CHAPTER 50 MULTICAST VLAN.....</b>	<b>50-1</b>
50.1 INTRODUCTIONS TO MULTICAST VLAN.....	50-1
50.2 MULTICAST VLAN CONFIGURATION TASK LIST.....	50-1
50.3 MULTICAST VLAN EXAMPLES.....	50-2
<b>CHAPTER 51 ACL CONFIGURATION.....</b>	<b>51-1</b>
51.1 INTRODUCTION TO ACL.....	51-1
51.1.1 Access-list.....	51-1
51.1.2 Access-group.....	51-1
51.1.3 Access-list Action and Global Default Action.....	51-1
51.2 ACL CONFIGURATION TASK LIST.....	51-2
51.3 ACL EXAMPLE.....	51-19
51.4 ACL TROUBLESHOOTING.....	51-23
<b>CHAPTER 52 802.1X CONFIGURATION.....</b>	<b>52-1</b>
52.1 INTRODUCTION TO 802.1X.....	52-1
52.1.1 The Authentication Structure of 802.1x.....	52-1
52.1.2 The Work Mechanism of 802.1x.....	52-3
52.1.3 The Encapsulation of EAPOL Messages.....	52-3
52.1.4 The Encapsulation of EAP Attributes.....	52-5
52.1.5 Web Authentication Proxy based on 802.1x.....	52-5
52.1.6 The Extension and Optimization of 802.1x.....	52-10
52.1.7 The Features of VLAN Allocation.....	52-11
52.2 802.1X CONFIGURATION TASK LIST.....	52-12
52.3 802.1X APPLICATION EXAMPLE.....	52-15
52.3.1 Examples of Guest Vlan Applications.....	52-15
52.3.2 Examples of IPv4 Radius Applications.....	52-17

52.3.3 Examples of IPv6 Radius Application .....	52-18
52.4 802.1X TROUBLESHOOTING .....	52-19
<b>CHAPTER 53 THE NUMBER LIMITATION FUNCTION OF PORT, MAC IN VLAN AND IP CONFIGURATION .....</b>	<b>53-1</b>
53.1 INTRODUCTION TO THE NUMBER LIMITATION FUNCTION OF PORT, MAC IN VLAN AND IP .....	53-1
53.2 THE NUMBER LIMITATION FUNCTION OF PORT, MAC IN VLAN AND IP CONFIGURATION TASK SEQUENCE .....	53-2
53.3 THE NUMBER LIMITATION FUNCTION OF PORT, MAC IN VLAN AND IP TYPICAL EXAMPLES.....	53-4
53.4 THE NUMBER LIMITATION FUNCTION OF PORT, MAC IN VLAN AND IP TROUBLESHOOTING HELP.....	53-5
<b>CHAPTER 54 OPERATIONAL CONFIGURATION OF AM FUNCTION .....</b>	<b>54-1</b>
54.1 INTRODUCTION TO AM FUNCTION .....	54-1
54.2 AM FUNCTION CONFIGURATION TASK LIST .....	54-1
54.3 AM FUNCTION EXAMPLE .....	54-3
54.4 AM FUNCTION TROUBLESHOOTING .....	54-3
<b>CHAPTER 55 TACACS+ CONFIGURATION .....</b>	<b>55-1</b>
55.1 INTRODUCTION TO TACACS+ .....	55-1
55.2 TACACS+ CONFIGURATION TASK LIST .....	55-1
55.3 TACACS+ SCENARIOS TYPICAL EXAMPLES.....	55-2
55.4 TACACS+ TROUBLESHOOTING .....	55-3
<b>CHAPTER 56 RADIUS CONFIGURATION .....</b>	<b>56-1</b>
56.1 INTRODUCTION TO RADIUS .....	56-1
56.1.1 AAA and RADIUS Introduction .....	56-1
56.1.2 Message structure for RADIUS.....	56-1
56.2 RADIUS CONFIGURATION TASK LIST .....	56-3
56.3 RADIUS TYPICAL EXAMPLES .....	56-5
56.3.1 IPv4 Radius Example.....	56-5
56.3.2 IPv6 RADIUS Example .....	56-6
56.4 RADIUS TROUBLESHOOTING .....	56-6
<b>CHAPTER 57 SSL CONFIGURATION.....</b>	<b>57-7</b>
57.1 INTRODUCTION TO SSL .....	57-7
57.1.1 Basic Element of SSL .....	57-7
57.2 SSL CONFIGURATION TASK LIST .....	57-8
57.3 SSL TYPICAL EXAMPLE .....	57-9
57.4 SSL TROUBLESHOOTING .....	57-10

<b>CHAPTER 58 IPV6 SECURITY RA CONFIGURATION</b> .....	<b>58-1</b>
58.1 INTRODUCTION TO IPV6 SECURITY RA.....	58-1
58.2 IPV6 SECURITY RA CONFIGURATION TASK SEQUENCE.....	58-1
58.3 IPV6 SECURITY RA TYPICAL EXAMPLES.....	58-2
58.4 IPV6 SECURITY RA TROUBLESHOOTING HELP.....	58-2
<b>CHAPTER 59 VLAN-ACL CONFIGURATION</b> .....	<b>59-1</b>
59.1 INTRODUCTION TO VLAN-ACL .....	59-1
59.2 VLAN-ACL CONFIGURATION TASK LIST .....	59-1
59.3 VLAN-ACL CONFIGURATION EXAMPLE.....	59-3
59.4 VLAN-ACL TROUBLESHOOTING.....	59-4
<b>CHAPTER 60 MAB CONFIGURATION</b> .....	<b>60-5</b>
60.1 INTRODUCTION TO MAB.....	60-5
60.2 MAB CONFIGURATION TASK LIST.....	60-5
60.3 MAB EXAMPLE .....	60-7
60.4 MAB TROUBLESHOOTING .....	60-9
<b>CHAPTER 61 PPPOE INTERMEDIATE AGENT CONFIGURATION</b> .....	<b>61-10</b>
61.1 INTRODUCTION TO PPPoE INTERMEDIATE AGENT .....	61-10
61.1.1 Brief Introduction to PPPoE .....	61-10
61.1.2 Introduction to PPPoE IA .....	61-10
61.2 PPPoE INTERMEDIATE AGENT CONFIGURATION TASK LIST .....	61-14
61.3 PPPoE INTERMEDIATE AGENT TYPICAL APPLICATION.....	61-15
61.4 PPPoE INTERMEDIATE AGENT TROUBLESHOOTING .....	61-16
<b>CHAPTER 62 SAVI CONFIGURATION</b> .....	<b>62-17</b>
62.1 INTRODUCTION TO SAVI.....	62-17
62.2 SAVI CONFIGURATION .....	62-17
62.3 SAVI TYPICAL APPLICATION .....	62-21
62.4 SAVI TROUBLESHOOTING .....	62-23
<b>CHAPTER 63 WEB PORTAL CONFIGURATION</b> .....	<b>63-24</b>
63.1 INTRODUCTION TO WEB PORTAL AUTHENTICATION.....	63-24
63.2 WEB PORTAL AUTHENTICATION CONFIGURATION TASK LIST.....	63-24
63.3 WEB PORTAL AUTHENTICATION TYPICAL EXAMPLE.....	63-26
63.4 WEB PORTAL AUTHENTICATION TROUBLESHOOTING.....	63-27

<b>CHAPTER 64 VRRP CONFIGURATION</b> .....	<b>64-28</b>
64.1 INTRODUCTION TO VRRP .....	64-28
64.2 VRRP CONFIGURATION TASK LIST .....	64-29
64.3 VRRP TYPICAL EXAMPLES .....	64-30
64.4 VRRP TROUBLESHOOTING .....	64-31
<b>CHAPTER 65 IPV6 VRRPV3 CONFIGURATION</b> .....	<b>65-1</b>
65.1 INTRODUCTION TO VRRPV3 .....	65-1
65.1.1 The Format of VRRPV3 Message .....	65-2
65.1.2 VRRPV3 Working Mechanism .....	65-3
65.2 VRRPV3 CONFIGURATION .....	65-4
65.2.1 Configuration Task Sequence .....	65-4
65.3 VRRPV3 TYPICAL EXAMPLES .....	65-5
65.4 VRRPV3 TROUBLESHOOTING .....	65-6
<b>CHAPTER 66 MRPP CONFIGURATION</b> .....	<b>66-1</b>
66.1 INTRODUCTION TO MRPP .....	66-1
66.1.1 Conception Introduction .....	66-1
66.1.2 MRPP Protocol Packet Types .....	66-2
66.1.3 MRPP Protocol Operation System .....	66-3
66.2 MRPP CONFIGURATION TASK LIST .....	66-3
66.3 MRPP TYPICAL SCENARIO .....	66-5
66.4 MRPP TROUBLESHOOTING .....	66-7
<b>CHAPTER 67 ULPP CONFIGURATION</b> .....	<b>67-1</b>
67.1 INTRODUCTION TO ULPP .....	67-1
67.2 ULPP CONFIGURATION TASK LIST .....	67-2
67.3 ULPP TYPICAL EXAMPLES .....	67-5
67.3.1 ULPP Typical Example1 .....	67-5
67.3.2 ULPP Typical Example2 .....	67-6
67.4 ULPP TROUBLESHOOTING .....	67-8
<b>CHAPTER 68 ULSM CONFIGURATION</b> .....	<b>68-1</b>
68.1 INTRODUCTION TO ULSM .....	68-1
68.2 ULSM CONFIGURATION TASK LIST .....	68-2
68.3 ULSM TYPICAL EXAMPLE .....	68-3
68.4 ULSM TROUBLESHOOTING .....	68-4
<b>CHAPTER 69 MIRROR CONFIGURATION</b> .....	<b>69-5</b>



69.1 INTRODUCTION TO MIRROR.....	69-5
69.2 MIRROR CONFIGURATION TASK LIST.....	69-5
69.3 MIRROR EXAMPLES .....	69-6
69.4 DEVICE MIRROR TROUBLESHOOTING.....	69-7
<b>CHAPTER 70 RSPAN CONFIGURATION .....</b>	<b>70-1</b>
70.1 INTRODUCTION TO RSPAN .....	70-1
70.2 RSPAN CONFIGURATION TASK LIST .....	70-2
70.3 TYPICAL EXAMPLES OF RSPAN.....	70-4
70.4 RSPAN TROUBLESHOOTING.....	70-7
<b>CHAPTER 71 SFLOW CONFIGURATION.....</b>	<b>71-1</b>
71.1 INTRODUCTION TO SFLOW .....	71-1
71.2 SFLOW CONFIGURATION TASK LIST .....	71-1
71.3 SFLOW EXAMPLES.....	71-3
71.4 SFLOW TROUBLESHOOTING .....	71-4
<b>CHAPTER 72 SNTP CONFIGURATION .....</b>	<b>72-1</b>
72.1 INTRODUCTION TO SNTP .....	72-1
72.2 TYPICAL EXAMPLES OF SNTP CONFIGURATION .....	72-2
<b>CHAPTER 73 NTP FUNCTION CONFIGURATION .....</b>	<b>73-1</b>
73.1 INTRODUCTION TO NTP FUNCTION .....	73-1
73.2 NTP FUNCTION CONFIGURATION TASK LIST .....	73-1
73.3 TYPICAL EXAMPLES OF NTP FUNCTION.....	73-4
73.4 NTP FUNCTION TROUBLESHOOTING.....	73-4
<b>CHAPTER 74 DNSV4/V6 CONFIGURATION .....</b>	<b>74-1</b>
74.1 INTRODUCTION TO DNS .....	74-1
74.2 DNSV4/V6 CONFIGURATION TASK LIST .....	74-2
74.3 TYPICAL EXAMPLES OF DNS.....	74-4
74.4 DNS TROUBLESHOOTING.....	74-5
<b>CHAPTER 75 SUMMER TIME CONFIGURATION .....</b>	<b>75-6</b>
75.1 INTRODUCTION TO SUMMER TIME .....	75-6
75.2 SUMMER TIME CONFIGURATION TASK SEQUENCE .....	75-6
75.3 EXAMPLES OF SUMMER TIME .....	75-6
75.4 SUMMER TIME TROUBLESHOOTING.....	75-7

<b>CHAPTER 76 MONITOR AND DEBUG .....</b>	<b>76-1</b>
76.1 PING .....	76-1
76.2 PING6 .....	76-1
76.3 TRACEROUTE .....	76-1
76.4 TRACEROUTE6 .....	76-1
76.5 SHOW .....	76-2
76.6 DEBUG .....	76-3
76.7 SYSTEM LOG .....	76-3
76.7.1 System Log Introduction .....	76-3
76.7.2 System Log Configuration.....	76-5
76.7.3 System Log Configuration Example.....	76-6
<b>CHAPTER 77 RELOAD SWITCH AFTER SPECIFIED TIME .....</b>	<b>77-1</b>
77.1 INTRODUCE TO RELOAD SWITCH AFTER SPECIFIED TIME .....	77-1
77.2 RELOAD SWITCH AFTER SPECIFIED TIME TASK LIST.....	77-1
<b>CHAPTER 78 DEBUGGING AND DIAGNOSIS FOR PACKETS RECEIVED AND SENT BY CPU .....</b>	<b>78-1</b>
78.1 INTRODUCTION TO DEBUGGING AND DIAGNOSIS FOR PACKETS RECEIVED AND SENT BY CPU.....	78-1
78.2 DEBUGGING AND DIAGNOSIS FOR PACKETS RECEIVED AND SENT BY CPU TASK LIST .....	78-1
<b>CHAPTER 79 VSF .....</b>	<b>79-2</b>
79.1 OVERVIEW.....	79-2
79.1.1 Introduction of VSF .....	79-2
79.1.2 Basic Concept .....	79-4
79.1.3 Glossary .....	79-5
79.1.4 VSF Typical Application.....	79-6
79.1.5 LACP MAD .....	79-6
79.1.6 BFD MAD .....	79-7
79.2 RELEVANT VSF CONFIGURATION .....	79-8
79.2.1 VSF Configuration .....	79-8
79.2.2 LACP MAD Configuration .....	79-10
79.2.3 BFD MAD Configuration.....	79-11
79.3 TYPICAL VSF EXAMPLE .....	79-12
79.4 VSF TROUBLESHOOTING .....	79-15
<b>CHAPTER 80 POE CONFIGURATION .....</b>	<b>80-1</b>
80.1 INTRODUCTION TO PoE.....	80-1
80.2 PoE CONFIGURATION .....	80-1
80.3 TYPICAL APPLICATION OF PoE.....	80-3

80.4 PoE TROUBLESHOOTING HELP .....	80-4
<b>CHAPTER 81 SWITCH OPERATION .....</b>	<b>81-5</b>
81.1 ADDRESS TABLE.....	81-5
81.2 LEARNING .....	81-5
81.3 FORWARDING & FILTERING.....	81-5
81.4 STORE-AND-FORWARD .....	81-5
81.5 AUTO-NEGOTIATION.....	81-6
<b>CHAPTER 82 TROUBLESHOOTING .....</b>	<b>82-1</b>
<b>CHAPTER 83 APPENDIX A.....</b>	<b>83-1</b>
83.1 A.1 SWITCH'S RJ45 PIN ASSIGNMENTS.....	83-1
83.2 A.2 10/100MBPS, 10/100BASE-TX.....	83-1
<b>CHAPTER 84 GLOSSARY.....</b>	<b>84-1</b>

# Chapter 1 INTRODUCTION

Thank you for purchasing PLANET Industrial L3 Managed Gigabit/10 Gigabit Ethernet Switch. The description of this model is shown below:

<b>SGS-6341-24T4X</b>	Layer 3 24-Port 10/100/1000T + 4-Port 10G SFP+ Stackable Managed Switch
<b>SGS-6341-24P4X</b>	Layer 3 24-Port 10/100/1000T 802.3at PoE + 4-Port 10G SFP+ Stackable Managed Switch (370W)
<b>SGS-6341-48T4X</b>	Layer 3 48-Port 10/100/1000T + 4-Port 10G SFP+ Stackable Managed Switch

## 1.1 Packet Contents

Open the box of the Managed Switch and carefully unpack it. The box should contain the following items:

- ◆ **The Managed Switch**
- ◆ **Quick Installation Guide**
- ◆ **RJ45 to RS232 Cable**
- ◆ **Rubber Feet**
- ◆ **Two Rack-mounting Brackets with Attachment Screws**
- ◆ **Power Cord**
- ◆ **SFP Dust-proof Caps**
- ◆ **RJ45 Dust-proof Caps**

	<b>SFP Dust-proof Caps</b>	<b>SFP+ Dust-proof Caps</b>
<b>SGS-6341-24T4X</b>	-	4
<b>SGS-6341-24P4X</b>	4	4
<b>SGS-6341-48T4X</b>	-	4

If any of these are missing or damaged, please contact your dealer immediately; if possible, retain the carton including the original packing material, and use them again to repack the product in case there is a need to return it to us for repair.

## 1.2 Product Description

### Powerful Layer 3 Gigabit Routing and Power over Ethernet Solution

PLANET SGS-6341 Series is a Layer 3 Stackable Managed Gigabit Switch that provides high-density performance, **Layer 3 static routing, RIP (Routing Information Protocol) and OSPF (Open Shortest Path First)**. With 10Gbps uplink interfaces capability, the SGS-6341 Series can handle extremely large amounts of data in a secure topology linking to an enterprise backbone or high capacity servers. The powerful WRR (Weighted Round Robin) and Network Security features make the SGS-6341 Series perform effective data traffic control for ISP and enterprise VoIP, video streaming, and multicast applications.

### High Performance 10Gbps Ethernet Capacity

The four SFP+ slots built in the SGS-6341 Series boasts a high-performance switch architecture that is capable of providing non-blocking switch fabric and wire-speed throughput as high as up to 176Gbps, which greatly simplifies the tasks of upgrading the LAN for catering to increasing bandwidth demands. Each of the SFP+ slots supports **Dual-Speed, 10GBASE-SR/LR or 1000BASE-SX/LX**, meaning the administrator now can flexibly choose the suitable SFP/SFP+ transceiver according to the transmission distance or the transmission speed required to extend the network efficiently.

### IP Stacking Management

The SGS-6341 Series supports IP stacking function that helps network managers to easily configure up to 24 switches in the same series via one single IP address instead of connecting and setting each unit one by one. The IP Stacking technology groups PLANET SGS-6341 Series and SGS-6340 Series together to enable centralized management through a single unit, regardless of physical location or switch type, as long as they are connected to the same local network.

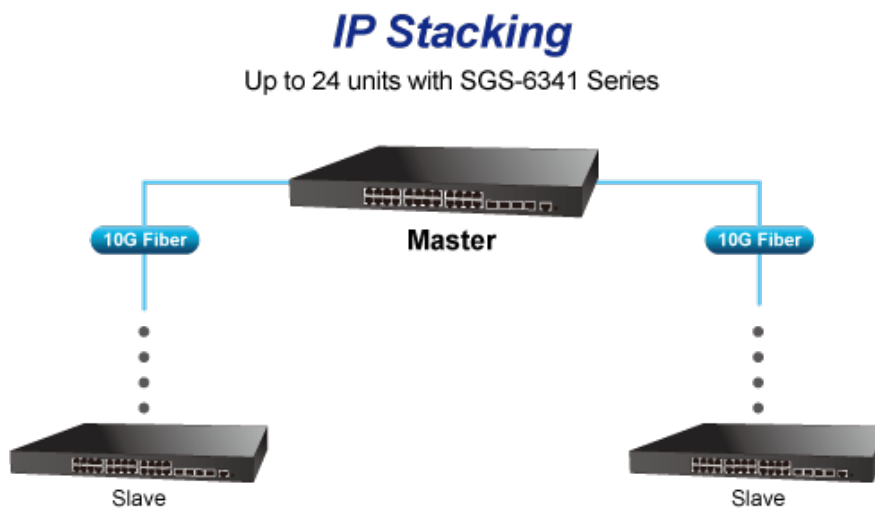

### Layer 3 Routing Support

The SGS-6341 Series enables the administrator to conveniently boost network efficiency by configuring Layer 3 static routing manually, the RIP (Routing Information Protocol) or OSPF (Open Shortest Path First) settings automatically.

- ▶ The RIP can employ the hop count as a routing metric and prevent routing loops by implementing a limit on the number of hops allowed in a path from the source to a destination.
- ▶ The OSPF is an interior dynamic routing protocol for autonomous system based on link state. The protocol creates a database for link state by exchanging link states among Layer3 switches, and then uses the Shortest Path First algorithm to generate a route table based on that database.

## Full IPv6 Support

The SGS-6341 Series provides **IPv6 management** and enterprise-level secure features such as **SSH**, **ACL**, **WRR** and **RADIUS** authentication. It thus helps the enterprises to step in the IPv6 era with the lowest investment. In addition, you don't need to replace the network facilities when the IPv6 FTTx edge network is built.

## Robust Layer 2 Features

The SGS-6341 Series can be programmed for basic switch management functions such as port speed configuration, port aggregation, VLAN, Multiple Spanning Tree Protocol, WRR, bandwidth control and IGMP snooping. This switch provides 802.1Q tagged VLAN, Q-in-Q, voice VLAN and GVRP Protocol functions. By supporting port aggregation, the SGS-6341 Series allows the operation of a high-speed trunk combined with multiple ports. It enables up to 16 groups for trunking with a maximum of 8 ports for each group.



## Excellent Layer 2 to Layer 4 Traffic Control

The SGS-6341 Series is loaded with powerful traffic management and WRR features to enhance services offered by telecoms. The WRR functionalities include wire-speed Layer 4 traffic classifiers and bandwidth limitation which are particularly useful for multi-tenant unit, multi-business unit, Telco, or network service applications. It also empowers the enterprises to take full advantage of the limited network resources and guarantees the best in VoIP and video conferencing transmission.

## Powerful Security

The SGS-6341 Series supports ACL policies comprehensively. The traffic can be classified by source/destination IP addresses, source/destination MAC addresses, IP protocols, TCP/UDP, IP precedence, time ranges and ToS. Moreover, various policies can be conducted to forward the traffic. The SGS-6341 Series also provides IEEE 802.1x port based access authentication, which can be deployed with RADIUS, to ensure the port level security and block illegal users.

## Efficient and Secure Management

For efficient management, the SGS-6341 Series Managed Gigabit Switch is equipped with console, Web and SNMP management interfaces. With its built-in Web-based management interface, the SGS-6341 Series offers an easy-to-use, platform-independent management and configuration facility. The SGS-6341 Series supports standard Simple Network Management Protocol (SNMP) and can be managed via any standard-based management software. For reducing product learning time, the SGS-6341 Series offers Cisco-like command via Telnet or console port and customer doesn't need to learn new command from these switches. Moreover, the SGS-6341 Series offers secure remote management by supporting SSH connection which encrypts the packet content at each session.



### Intelligent SFP Diagnosis Mechanism

The SGS-6341 Series supports **SFP-DDM (Digital Diagnostic Monitor)** function that greatly helps network administrator to easily monitor real-time parameters of the SFP and SFP+ transceivers, such as optical output power, optical input power, temperature, laser bias current, and transceiver supply voltage.

### Digital Diagnostic Monitor (DDM)

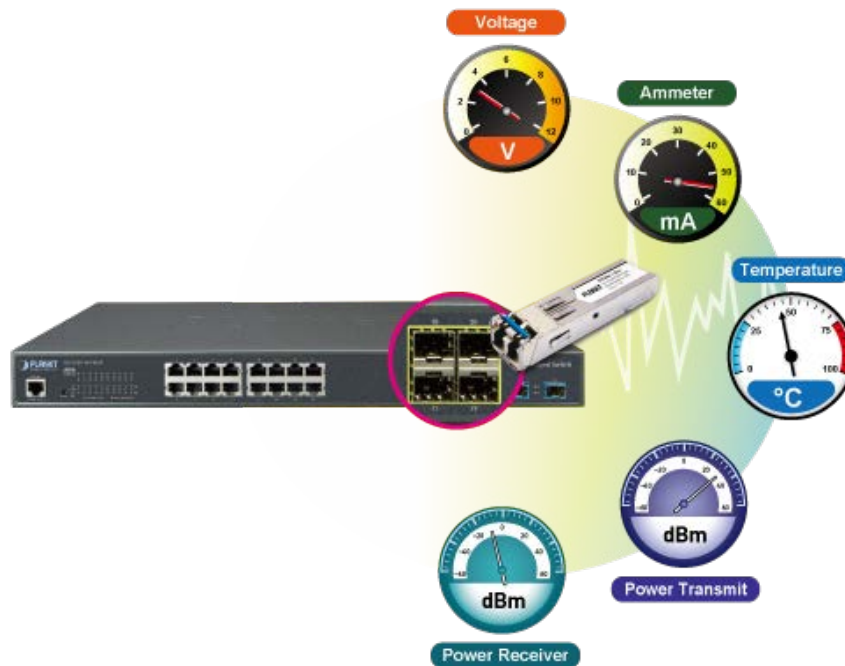

### Centralized Power Management for Gigabit Ethernet PoE Networking

To fulfill the needs of higher power required PoE network applications with Gigabit speed transmission, the SGS-6341-24P4X features high-performance Gigabit IEEE 802.3at PoE+ (up to 30 watts) on all ports. It perfectly meets the power requirements of PoE VoIP phone and all kinds of PoE IP cameras such as IR, PTZ, speed dome cameras or even box type IP cameras with built-in fan and heater.

The SGS-6341-24P4X's PoE capabilities also help to reduce deployment costs for network devices as a result of freeing from the restrictions of power outlet locations. Power and data switching are integrated into one unit, delivered over a single cable and managed centrally. It thus eliminates the cost for additional AC wiring and reduces installation time.

### PoE Schedule for Energy Saving

Besides being used for IP surveillance, the SGS-6341-24P4X is certainly applicable to build any PoE network



including VoIP and wireless LAN. Under the trend of energy saving worldwide and contributing to the environmental protection on the Earth, the SGS-6341-24P4X can effectively control the power supply besides its capability of giving high watts power. The “PoE schedule” function helps you to enable or disable PoE power feeding for each PoE port during specified time intervals and it is a powerful function to help SMBs or enterprises save energy and budget.

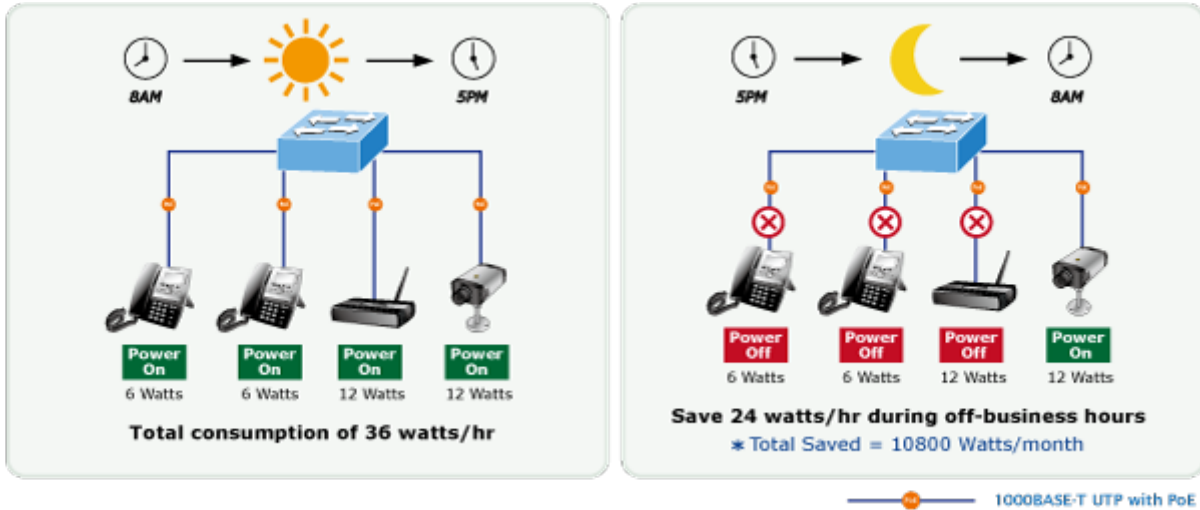

## 1.3 Product Features

### ➤ Physical Port

#### **SGS-6341-24T4X**

- 24-port 10/100/1000BASE-T Gigabit Ethernet RJ45
- 4 **10GBASE-SR/LR SFP+** slots, compatible with 1000BASE-SX/LX/BX SFP
- RJ45 to DB9 console interface for switch basic management and setup

#### **SGS-6341-24P4X**

- 24-port 10/100/1000BASE-T Gigabit Ethernet RJ45 with 24-port **IEEE 802.3at/af PoE** injector
- 4 **10GBASE-SR/LR SFP+** slots, compatible with 1000BASE-SX/LX/BX SFP
- RJ45 to DB9 console interface for switch basic management and setup

#### **SGS-6341-48T4X**

- 48-port 10/100/1000BASE-T Gigabit Ethernet RJ45
- 4 **10GBASE-SR/LR SFP+** slots, compatible with 1000BASE-SX/LX/BX SFP
- RJ45 to DB9 console interface for switch basic management and setup

### ➤ Power over Ethernet (SGS-6341-24P4X)

- Complies with IEEE 802.3at Power over Ethernet Plus, end-span PSE
- Backward compatible with IEEE 802.3af Power over Ethernet
- Up to 24 ports of IEEE 802.3af/802.3at devices powered
- Supports PoE power up to 30 watts for each PoE port
- Auto detects powered device (PD)
- Circuit protection prevents power interference between ports
- Remote power feeding up to 100 meters
- PoE management
  - Total PoE power budget control
  - Per port PoE function enable/disable
  - PoE port power feeding priority
  - Per PoE port power limitation
  - PD classification detection
  - PoE schedule

### ➤ IP Stacking

- Connects with stack member via both Gigabit TP/SFP interface and 10G SFP+ slots
- Single IP address management, supporting up to 24 units stacked together

### ➤ IP Routing Features

- IP routing protocol supports **RIPv1/v2, RIPng, OSPFv2/v3, BGP4/4+**
- Routing interface provides per VLAN routing mode
- **VRRPv1/v3** protocol for redundant routing deployment
- Supports route redistribution

➤ **Multicast Routing Features**

- Supports PIM-DM (Protocol Independent Multicast – Dense Mode) and PIM-SM (Protocol Independent Multicast – Sparse Mode) and PIM-SSM (Protocol Independent Multicast – Source Specific Multicast)
- Supports DVMRP (Distance Vector Multicast Routing Protocol)
- Supports IGMP v1/v2/v3 and MLD v1/v2

➤ **Layer 2 Features**

- Complies with the IEEE 802.3, IEEE 802.3u, IEEE 802.3ab, IEEE 802.3z Gigabit Ethernet standard
- Supports auto-negotiation and half-duplex/full-duplex modes for all 10BASE-T, 100BASE-TX and 1000BASE-T ports
- Auto-MDI/MDI-X detection on each RJ45 port
- Prevents packet loss flow control
  - IEEE 802.3x pause frame flow control in full-duplex mode
  - Back-pressure flow control in half-duplex mode
- High performance Store-and-Forward architecture, broadcast storm control, port loopback detect
- 16K MAC address table, automatic source address learning and aging
- Supports VLAN
  - IEEE 802.1Q tag-based VLAN
  - GVRP for dynamic VLAN management
  - Up to 256 VLANs groups, out of 4041 VLAN IDs
  - Provider Bridging (VLAN Q-in-Q, IEEE 802.1ad) supported
  - Private VLAN Edge (PVE) supported
  - GVRP protocol for Management VLAN
  - Protocol-based VLAN
  - MAC-based VLAN
  - IP subnet VLAN
- Supports Link Aggregation
  - Maximum 12 trunk groups, up to 8 ports per trunk group
  - IEEE 802.3ad LACP (Link Aggregation Control Protocol)
  - Cisco ether-channel (static trunk)
- Supports Spanning Tree Protocol
  - STP, IEEE 802.1D (Classic Spanning Tree Protocol)
  - RSTP, IEEE 802.1w (Rapid Spanning Tree Protocol)
  - MSTP, IEEE 802.1s (Multiple Spanning Tree Protocol, spanning tree by VLAN)
  - Supports BPDU & root guard
- Port mirroring to monitor the incoming or outgoing traffic on a particular port (many to many)
- Provides port mirror (many-to-1)

➤ **Quality of Service**

- 8 priority queues on all switch ports
- Support for strict priority and WRR (Weighted Round Robin) CoS policies
- Traffic classification
  - IEEE 802.1p CoS/ToS
  - IPv4/IPv6 DSCP

- Port-based WRR
- Strict priority and WRR CoS policies
  
- **Multicast**
  - Supports IPv4 IGMP snooping v1, v2 and v3; IPv6 MLD v1 and v2 snooping
  - Querier mode support
  - Supports Multicast VLAN Register (MVR)
  
- **Security**
  - IEEE 802.1x port-based network access authentication
  - MAC-based network access authentication
  - Built-in RADIUS client to cooperate with the RADIUS servers for IPv4 and IPv6
  - TACACS+ login users access authentication
  - IP-based Access Control List (ACL)
  - MAC-based Access Control List
  - Supports DHCP snooping
  - Supports ARP inspection
  - **IP Source Guard** prevents IP spoofing attacks
  - **Dynamic ARP Inspection** discards ARP packets with invalid MAC address to IP address binding
  
- **Management**
  - Management IP for IPv4 and IPv6
  - Switch Management Interface
    - Console/Telnet Command Line Interface
    - Web switch management
    - SNMP v1, v2c, and v3 switch management
    - SSH/SSL secure access
  - BOOTP and DHCP for IP address assignment
  - Firmware upload/download via TFTP or HTTP Protocol for IPv4 and IPv6
  - SNTP (Simple Network Time Protocol) for IPv4 and IPv6
  - User privilege levels control
  - Syslog server for IPv4 and IPv6
  - Supports DDM
  - Four RMON groups 1, 2, 3, 9 (history, statistics, alarms and events)
  - Supports sFlow
  - Supports ULDP
  - Supports ULPP (Uplink Protection Protocol)
  - Supports ULSM (Uplink State Monitor protocol)
  - Supports LLDP/LLDP MED
  - Supports DHCP Option82, Option37/38
  - Supports ping, trace route function for IPv4 and IPv6

## 1.4 Product Specifications

Product	SGS-6341-24T4X	SGS-6341-24P4X	SGS-6341-48T4X
<b>Hardware Specifications</b>			
Hardware Version	2		1
10/100/1000 RJ45 Ports	24		48
100/1000BASE-X SFP/mini-GBIC Slots	-	4	-
SFP+ Slots	4 10GBASE-SR/LR SFP+ interface Compatible with 1000BASE-SX/LX/BX SFP transceiver		
Console	1 x RJ45-to-RS232 serial port (115200, 8, N, 1)		
Switch Architecture	Store-and-forward		
Switch Fabric	128Gbps/non-blocking		176Gbps/non-blocking
Switch Throughput	95.23Mpps		130.95Mpps
Address Table	16K MAC address table with auto learning function		
Shared Data Buffer	1.5MB		
Flow Control	Back pressure for half -duplex IEEE 802.3x pause frame for full -duplex		
Jumbo Frame	10KB		
LED	System: PWR/MGMT/SYS(SGS-6341-24T4X and SGS-6341-48T4X) PWR/MGMT/SYS/PoE(SGS-6341-24P4X) Ports: 10/100/1000T RJ45 Port: LNK/ACT and PoE-in-Use 1/10G SFP+ slot: LNK/ACT		
Dimensions (W x D x H)	440 x 240 x 43.6 mm	440 x 320 x 43.6 mm,	440 x 240 x 43.6 mm
Weight	3170g	4503g	3471g
Power Consumption	26 watts/88.66 BTU	15.4 watts/52.51BTU (System) 401.7 watts/ 1369.8 BTU (System+PoE)	46.4 watts/158.22 BTU
Power Requirements	AC 100~240V, 50/60Hz		
<b>Power over Ethernet (SGS-6341-24P4X)</b>			
PoE Standard	IEEE 802.3af/802.3at PoE+ PSE		
PoE Power Supply Type	End-span		
PoE Power Output	Per port 53V DC, 30.8 watts (max.)		
Power Pin Assignment	1/2(+), 3/6(-)		
PoE Power Budget	370 watts (max.)		
PoE Ability PD @ 9 watts	24 units		
PoE Ability PD @ 15 watts	24 units		
PoE Ability PD @ 30 watts	12 units		
<b>Management Function</b>			
System Configuration	Console, Telnet, SSH, Web browser, SNMP v1, v2c and v3		
Management	Supports both IPv4 and IPv6 addressing Supports the user IP security inspection for IPv4/IPv6 SNMP		

	<p>Supports MIB and TRAP</p> <p>Supports IPv4/IPv6 FTP/TFTP</p> <p>Supports IPv4/IPv6 NTP</p> <p>Supports RMON 1, 2, 3, 9 four groups</p> <p>Supports the RADIUS authentication for IPv4/IPv6 Telnet user name and password</p> <p>Supports IPv4/IPv6 SSH</p> <p>The right configuration for users to adopt RADIUS server's shell management</p> <p>Supports CLI, console, Telnet</p> <p>Supports SNMP v1, v2c and v3</p> <p>Supports Security IP safety net management function: avoid unlawful landing at nonrestrictive area</p> <p>Supports Syslog server for IPv4 and IPv6</p> <p>Supports TACACS+</p>
<b>IPv4 Layer 3 functions</b>	
<b>IP Routing Protocol</b>	<p>Static route, RIPv1/v2, OSPFv2, BGPv4</p> <p>Policy-based routing (PBR)</p> <p>LPM routing (MD5 authentication)</p>
<b>Multicast Routing Protocol</b>	IGMP v1/v2/v3, DVMRP, PIM-DM/SM, PIM-SSM
<b>Layer 3 Protocol</b>	VRRP v1/v3, ARP, ARP Proxy
<b>IPv6 Layer 3 functions</b>	
<b>IP Routing Protocol</b>	<p>RIPng, OSPFv3, BGPv4+,</p> <p>IPv6 LPM Routing, IPv6 Policy-based Routing(PBR)</p> <p>IPv6 VRRPv3, IPv6 URPF, IPv6 RA</p>
<b>Multicast Routing Protocol</b>	<p>PIM-SM/DM for IPv6</p> <p>MLD for IPv6 (v1)</p> <p>MLDv1/v2</p> <p>MLD Snooping, 6to4 Tunnels</p> <p>IPv6 Any Cast RP</p> <p>Multicast receive control</p> <p>Illegal multicast source detect</p>
<b>Layer 3 Protocol</b>	Configured Tunnels, ISATAP, GRE Tunnel
<b>Other</b>	ICMPv6, ND, DNSv6
<b>Layer 2 Function</b>	
<b>Port Configuration</b>	<p>Port disable/enable</p> <p>Auto-negotiation 10/100/1000Mbps full and half duplex mode selection</p> <p>Flow control disable/enable</p> <p>Bandwidth control on each port</p> <p>Port loopback detect</p>
<b>Port Status</b>	Display each port's speed duplex mode, link status, flow control status and auto negotiation status
<b>VLAN</b>	<p>802.1Q tagged based VLAN, up to 256 VLAN groups</p> <p>802.1ad Q-in-Q (VLAN stacking)</p> <p>GVRP for VLAN management</p> <p>Private VLAN Edge (PVE) supported</p> <p>Protocol-based VLAN</p> <p>MAC-based VLAN</p>

	IP subnet VLAN
<b>Bandwidth Control</b>	TX/RX/Both
<b>Link Aggregation</b>	IEEE 802.3ad LACP/static trunk Supports 12 groups with 8 ports per trunk group
<b>QoS</b>	8 priority queues on all switch ports Supports strict priority and Weighted Round Robin (WRR) CoS policies Traffic classification: <ul style="list-style-type: none"> <li>- IEEE 802.1p CoS/ToS</li> <li>- IPv4/IPv6 DSCP</li> <li>- Port-based WRR</li> </ul>
<b>Multicast</b>	IGMP v1/v2/v3 snooping Querier mode support MLD v1/v2 snooping Multicast VLAN Register (MVR)
<b>Access Control List</b>	Supports Standard and Expanded ACL IP-based ACL/MAC-based ACL Time-based ACL Up to 512 entries
<b>Bandwidth Control</b>	At least 64Kbps step
<b>Security</b>	Supports MAC + port binding IPv4/IPv6 + MAC + port binding IPv4/IPv6 + port binding Supports MAC filter ARP scanning prevention
<b>Authentication</b>	IEEE 802.1x port-based network access control AAA authentication: TACACS+ and IPv4/IPv6 over RADIUS
<b>SNMP MIBs</b>	RFC 1213 MIB-II RFC 1215 Internet Engineering Task Force RFC 1271 RMON RFC 1354 IP-Forwarding MIB RFC 1493 Bridge MIB RFC 1643 Ether-like MIB RFC 1907 SNMP v2 RFC 2011 IP/ICMP MIB RFC 2012 TCP MIB RFC 2013 UDP MIB RFC 2096 IP forward MIB RFC 2233 if MIB RFC 2452 TCP6 MIB RFC 2454 UDP6 MIB RFC 2465 IPv6 MIB RFC 2466 ICMP6 MIB RFC 2573 SNMP v3 notify RFC 2574 SNMP v3 vacm RFC 2674 Bridge MIB Extensions (IEEE 802.1Q MIB) RFC 2674 Bridge MIB Extensions (IEEE 802.1P MIB)
<b>Standard Conformance</b>	
<b>Regulatory Compliance</b>	FCC Part 15 Class A, CE
<b>Standards Compliance</b>	IEEE 802.3 10BASE-T



	<p>IEEE 802.3u 100BASE-TX  IEEE 802.3z Gigabit 1000BASE-SX/LX  IEEE 802.3ab Gigabit 1000BASE-T  IEEE 802.3ae 10Gb/s Ethernet  IEEE 802.3x flow control and back pressure  IEEE 802.3ad port trunk with LACP  IEEE 802.1D Spanning Tree Protocol  IEEE 802.1w Rapid Spanning Tree Protocol  IEEE 802.1s Multiple Spanning Tree Protocol  IEEE 802.1p Class of Service  IEEE 802.1Q VLAN tagging  IEEE 802.1X port authentication network control  IEEE 802.1ab LLDP  IEEE 802.3af Power over Ethernet  IEEE 802.3at Power over Ethernet PLUS  RFC 768 UDP  RFC 793 TFTP  RFC 791 IP  RFC 792 ICMP  RFC 2068 HTTP  RFC 1112 IGMP v1  RFC 2236 IGMP v2  RFC 3376 IGMP v3  RFC 2710 MLD v1  RFC 3810 MLD v2  RFC 2328 OSPF v2  RFC 1058 RIP v1  RFC 2453 RIP v2</p>
<b>Environment</b>	
<b>Operating</b>	<p>Temperature: 0 ~ 50 degrees C  Relative Humidity: 5 ~ 90% (non-condensing)</p>
<b>Storage</b>	<p>Temperature: -10 ~ 70 degrees C  Relative Humidity: 5 ~ 90% (non-condensing)</p>

# Chapter 2 INSTALLATION

This section describes the hardware features and installation of the Managed Switch on the desktop or rack mount. For easier management and control of the Managed Switch, familiarize yourself with its display indicators, and ports. Front panel illustrations in this chapter display the unit LED indicators. Before connecting any network device to the Managed Switch, please read this chapter completely.

## 2.1 Hardware Description

### 2.1.1 Switch Front Panel

The unit front panel provides a simple interface monitoring the switch. [Figure 2-1-1](#), [2-1-2](#) and [2-1-3](#) show the front panel of the Managed Switches.

#### SGS-6341-24T4X Front Panel



Figure 2-1-1 SGS-6341-24T4X front panel

#### SGS-6341-24P4X Front Panel



Figure 2-1-1 SGS-6341-24P4X front panel

#### SGS-6341-48T4X Front Panel

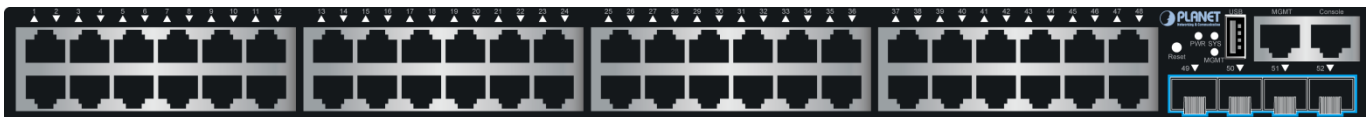

Figure 2-1-1 SGS-6341-48T4X front panel

#### ■ Gigabit TP interface

10/100/1000BASE-T copper, RJ45 twisted-pair: Up to 100 meters.

#### ■ SFP/SFP+ slots

SFP/SFP+ mini-GBIC slot, SFP (Small Factor Pluggable) transceiver module: From 550 meters (Multi-mode fiber) to 10/30/50/70/120 kilometers (Single-mode fiber).

#### ■ Console Port

The console port is an RJ45 type, RS232 male serial port connector. It is an interface for connecting a terminal directly. Through the console port, it provides rich diagnostic information including IP address

setting, factory reset, port management, link status and system setting. Users can use the attached RS232 cable in the package and connect to the console port on the device. After the connection, users can run any terminal emulation program (Hyper Terminal, ProComm Plus, Telix, Winterm and so on) to enter the startup screen of the device.

■ **USB Interface**

The USB port is a USB2.0 type; it is an interface for uploading/restoring the configuration/firmware.

■ **Alarm Port**

The alarm port is an RJ45 type, an interface for monitoring the external devices (such as alarm) when monitoring external devices has failed.

■ **MGMT Port**

The MGMT port is an RJ45 type, an independent interface for Telnet or SSH.

### 2.1.2 LED Indications

The front panel LEDs indicate instant status of port links, data activity, system operation, stack status and system power, and helps monitor and troubleshoot when needed.

**SGS-6341-24T4X LED Indication**

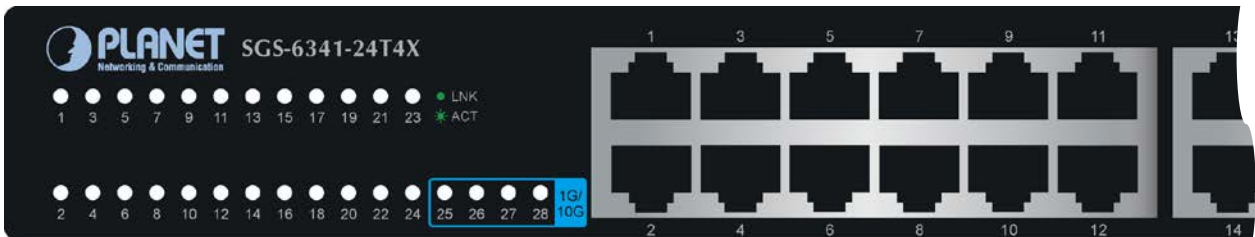

Figure 2-1-4 SGS-6341-24T4X LED panel

**SGS-6341-48T4X LED Indication**

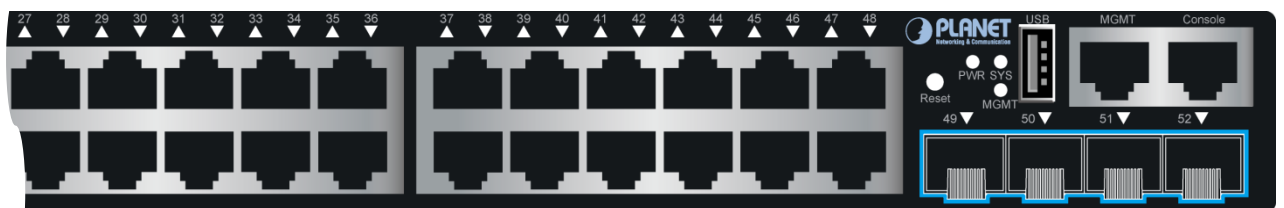

Figure 2-1-5 SGS-6341-48T4X LED panel

■ **System**

LED	Color	Function
PWR	Green	Lights to indicate that the Switch has power.
	Off	Power is off.
SYS	Green	Lights to indicate the system diagnosis is completed.
		Blinks to indicate system diagnosis is running.

MGMT	Green	Lights to indicate the link through that port is successfully established
		Blinks to indicate that the port is activity
	Off	No connection

■ 10/100/1000BASE-T Interfaces (Port-1 to Port-24)

LED	Color	Function	
LNK/ACT	Green	Lights:	To indicate the link through that port is successfully established.
		Blinks:	To indicate that the switch is actively sending or receiving data over that port.

■ 1/10G SFP+ Interfaces (Port-25 to Port-28)

LED	Color	Function	
LNK/ACT	Green	Lights:	To indicate the link through that port is successfully established.
		Blinks:	To indicate that the switch is actively sending or receiving data over that port.

SGS-6341-24P4X LED Indication

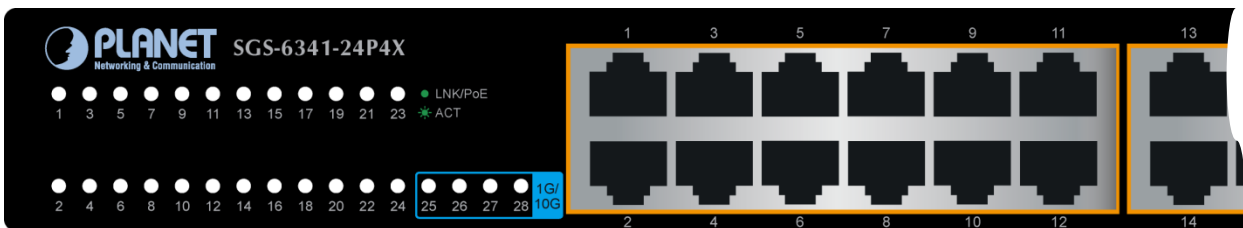

Figure 2-1-6 SGS-6341-24P4X LED panel

■ System

LED	Color	Function	
PWR	Green	Lights	to indicate that the Switch has power.
	Off		Power is off.
SYS	Green	Lights	to indicate the system diagnosis is completed.
		Blinks	to indicate system diagnosis is running.
MGMT	Green	Lights	to indicate the link through that port is successfully established
		Blinks	to indicate that the port is activity
	Off	No connection	

■ 10/100/1000BASE-T Interfaces (Port-1 to Port-24)

LED	Color	Function	
LNK/ACT	Green	Lights:	To indicate the link through that port is successfully established.

		<b>Blinks:</b>	To indicate that the switch is actively sending or receiving data over that port.
<b>PoE</b>	<b>Green</b>	<b>Lights:</b>	To indicate the port is providing DC in-line power with PoE+.

■ 1/10G SFP+ Interfaces (Port-25 to Port-28)

LED	Color	Function	
<b>LNK/ACT</b>	<b>Green</b>	<b>Lights:</b>	To indicate the link through that port is successfully established.
		<b>Blinks:</b>	To indicate that the switch is actively sending or receiving data over that port.

### 2.1.3 Switch Rear Panel

The rear panel of the Managed Switch indicates an AC inlet power socket, which accepts input power from 100 to 240V AC, 50-60Hz. Figure 2-1-7 shows the rear panel of these Managed Switches

**SGS-6341-24T4X/SGS-6341-48T4X/SGS-6341-24P4X Rear Panel**

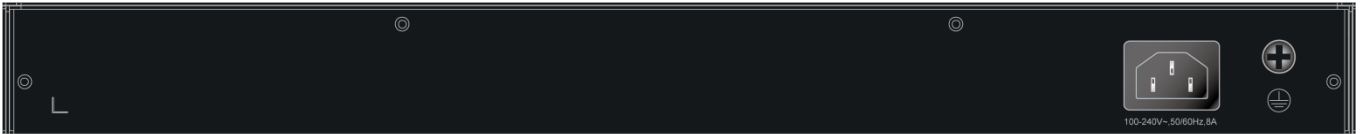

Figure 2-1-7 Rear panel of **SGS-6341-24T4X/SGS-6341-48T4X/SGS-6341-24P4X**

■ **AC Power Receptacle**

Compatible with electrical services in most areas of the world, the Managed Switch’s power supply automatically adjusts to line power in the range of 100-240VAC and 50/60 Hz.

Plug the female end of the power cord firmly into the receptacle on the rear panel of the Managed Switch. Plug the other end of the power cord into an electrical outlet and then the power will be ready.

## 2.2 Switch Installation

This section describes how to install your Managed Switch and make connections to the Managed Switch. Please read the following topics and perform the procedures in the order being presented. To install your Managed Switch on a desktop or shelf, simply complete the following steps.

### 2.2.1 Desktop Installation

To install the Managed Switch on desktop or shelf, please follow these steps:

**Step 1:** Attach the rubber feet to the recessed areas on the bottom of the Managed Switch.

**Step 2:** Place the Managed Switch on the desktop or the shelf near an AC power source, as shown in [Figure 2-2-1](#).

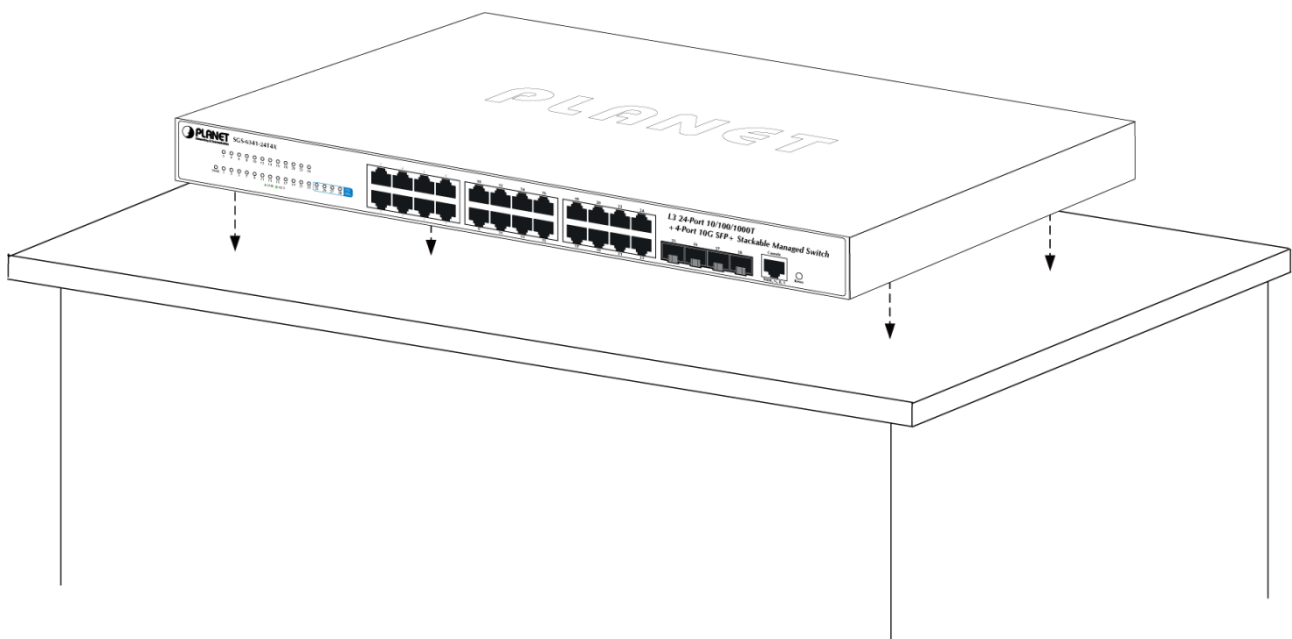

**Figure 2-2-1** Place the Managed Switch on the desktop

**Step 3:** Keep enough ventilation space between the Managed Switch and the surrounding objects.



When choosing a location, please keep in mind the environmental restrictions discussed in Chapter 1, Section 4 under **Specifications**.

**Step 4:** [Connect the Managed Switch to network devices.](#)

Connect one end of a standard network cable to the 10/100/1000 RJ45 ports on the front of the Managed Switch and connect the other end of the cable to the network devices such as printer servers, workstations or routers, etc.



Connection to the Managed Switch requires UTP Category 5 network cabling with RJ45 tips. For more information, please see the Cabling Specification in Appendix A.

**Step 5:** Supply power to the Managed Switch.

Connect one end of the power cable to the Managed Switch.

Connect the power plug of the power cable to a standard wall outlet.

When the Managed Switch receives power, the Power LED should remain solid Green.

## 2.2.2 Rack Mounting

To install the Managed Switch in a 19-inch standard rack, please follow the instructions described below:

**Step 1:** Place the Managed Switch on a hard flat surface, with the front panel positioned towards the front side.

**Step 2:** Attach the rack-mount bracket to each side of the Managed Switch with supplied screws attached to the package.

Figure 2-2-2 shows how to attach brackets to one side of the Managed Switch.

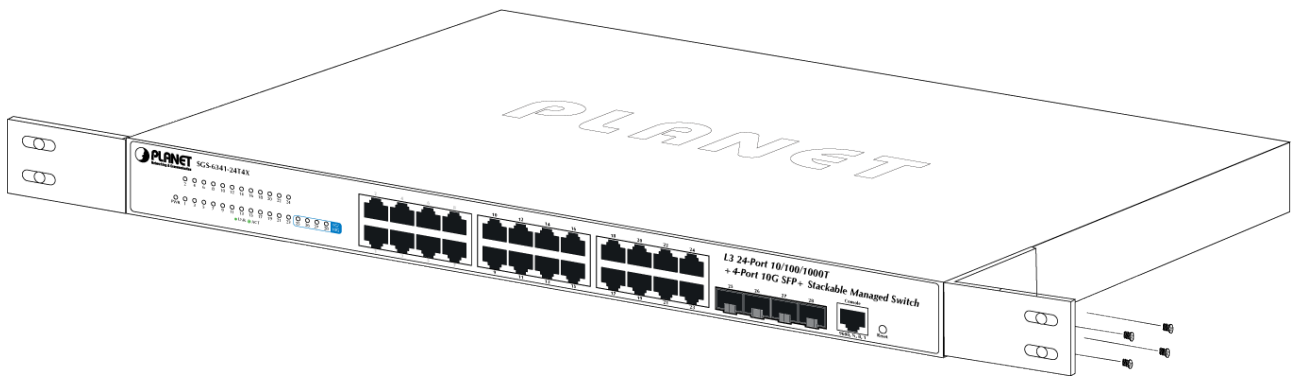

Figure 2-2-2 Attach brackets to the Managed Switch.



You must use the screws supplied with the mounting brackets. Damage caused to the parts by using incorrect screws would invalidate the warranty.

**Step 3:** Secure the brackets tightly.

**Step 4:** Follow the same steps to attach the second bracket to the opposite side.

**Step 5:** After the brackets are attached to the Managed Switch, use suitable screws to securely attach the brackets to the rack, as shown in Figure 2-2-3.

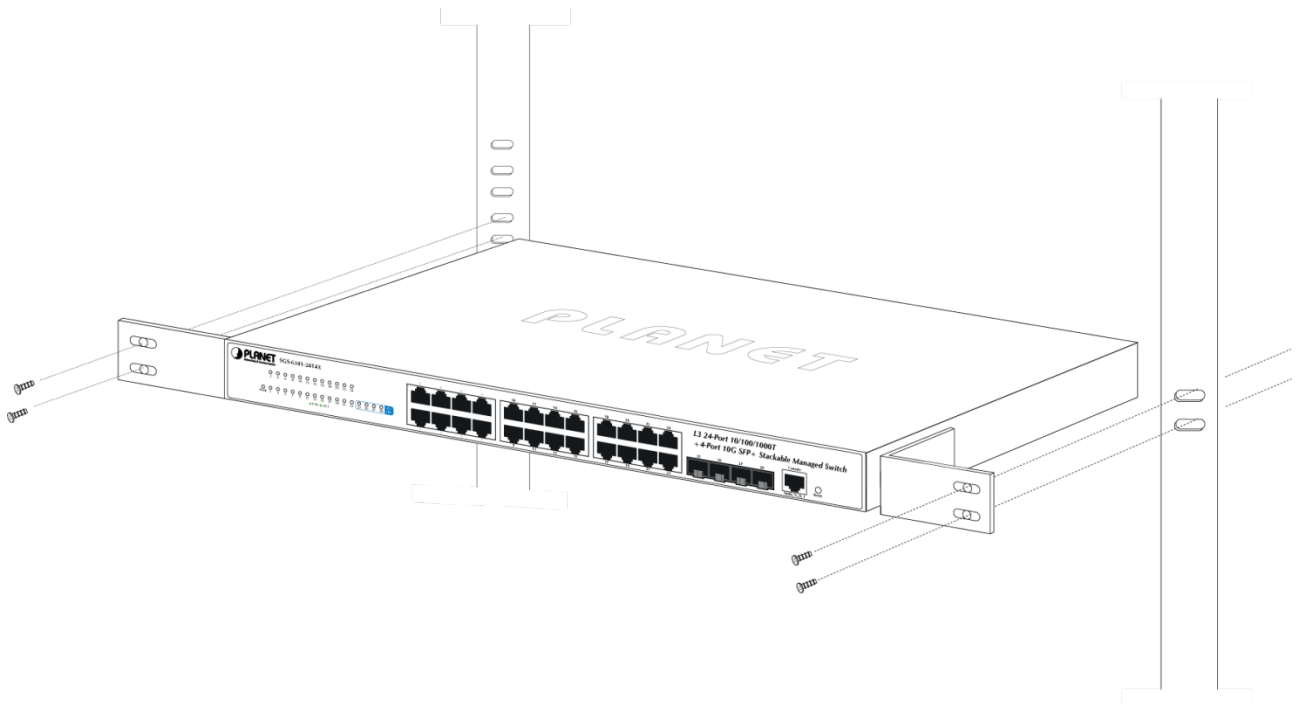

Figure 2-2-3 Mounting SGS-6341 Series in a Rack

**Step 6:** Proceed with Steps 4 and 5 of Session 2.2.1 Desktop Installation to connect the network cabling and supply power to the Managed Switch.

### 2.2.3 Installing the SFP/SFP+ Transceiver

The sections describe how to insert an SFP/SFP+ transceiver into an SFP/SFP+ slot. The SFP/SFP+ transceivers are hot-pluggable and hot-swappable. You can plug in and out the transceiver to/from any SFP/SFP+ port without having to power down the Managed Switch, as the [Figure 2-16](#) shows.

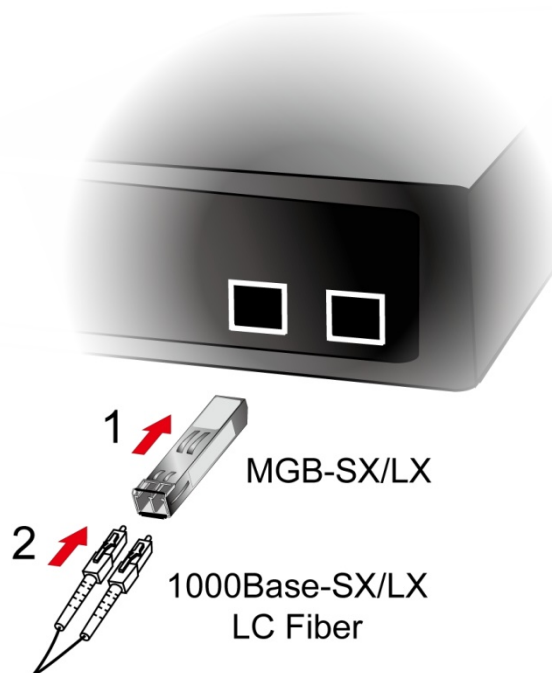

Figure 2-16 Plug in the SFP transceiver



**➤ Approved PLANET SFP/SFP+ Transceivers**

PLANET Managed Switch supports both single mode and multi-mode SFP/SFP+ transceivers. The following list of approved PLANET SFP/SFP+ transceivers is correct at the time of publication:

**Gigabit Ethernet Transceiver (1000BASE-X SFP)**

Model	Speed (Mbps)	Connector Interface	Fiber Mode	Distance	Wavelength (nm)	Operating Temp.
MGB-GT	1000	Copper	--	100m	--	0 ~ 60 degrees C
MGB-SX	1000	LC	Multi Mode	550m	850nm	0 ~ 60 degrees C
MGB-SX2	1000	LC	Multi Mode	2km	1310nm	0 ~ 60 degrees C
MGB-LX	1000	LC	Single Mode	10km	1310nm	0 ~ 60 degrees C
MGB-L30	1000	LC	Single Mode	30km	1310nm	0 ~ 60 degrees C
MGB-L50	1000	LC	Single Mode	50km	1550nm	0 ~ 60 degrees C
MGB-L70	1000	LC	Single Mode	70km	1550nm	0 ~ 60 degrees C
MGB-L120	1000	LC	Single Mode	120km	1550nm	0 ~ 60 degrees C
MGB-TSX	1000	LC	Multi Mode	550m	850nm	-40 ~ 75 degrees C
MGB-TLX	1000	LC	Single Mode	10km	1310nm	-40 ~ 75 degrees C
MGB-TL30	1000	LC	Single Mode	30km	1310nm	-40 ~ 75 degrees C
MGB-TL70	1000	LC	Single Mode	70km	1550nm	-40 ~ 75 degrees C

**Gigabit Ethernet Transceiver (1000BASE-BX, Single Fiber Bi-directional SFP)**

Model	Speed (Mbps)	Connector Interface	Fiber Mode	Distance	Wavelength (TX/RX)	Operating Temp.
MGB-LA10	1000	WDM(LC)	Single Mode	10km	1310nm/1550nm	0 ~ 60 degrees C
MGB-LB10	1000	WDM(LC)	Single Mode	10km	1550nm/1310nm	0 ~ 60 degrees C
MGB-LA20	1000	WDM(LC)	Single Mode	20km	1310nm/1550nm	0 ~ 60 degrees C
MGB-LB20	1000	WDM(LC)	Single Mode	20km	1550nm/1310nm	0 ~ 60 degrees C
MGB-LA40	1000	WDM(LC)	Single Mode	40km	1310nm/1550nm	0 ~ 60 degrees C
MGB-LB40	1000	WDM(LC)	Single Mode	40km	1550nm/1310nm	0 ~ 60 degrees C
MGB-LA60	1000	WDM(LC)	Single Mode	60km	1310nm/1550nm	0 ~ 60 degrees C
MGB-LB60	1000	WDM(LC)	Single Mode	60km	1550nm/1310nm	0 ~ 60 degrees C
MGB-TLA10	1000	WDM(LC)	Single Mode	10km	1310nm/1550nm	-40 ~ 75 degrees C
MGB-TLB10	1000	WDM(LC)	Single Mode	10km	1550nm/1310nm	-40 ~ 75 degrees C
MGB-TLA20	1000	WDM(LC)	Single Mode	20km	1310nm/1550nm	-40 ~ 75 degrees C
MGB-TLB20	1000	WDM(LC)	Single Mode	20km	1550nm/1310nm	-40 ~ 75 degrees C
MGB-TLA40	1000	WDM(LC)	Single Mode	40km	1310nm/1550nm	-40 ~ 75 degrees C
MGB-TLB40	1000	WDM(LC)	Single Mode	40km	1550nm/1310nm	-40 ~ 75 degrees C
MGB-TLA60	1000	WDM(LC)	Single Mode	60km	1310nm/1550nm	-40 ~ 75 degrees C
MGB-TLB60	1000	WDM(LC)	Single Mode	60km	1550nm/1310nm	-40 ~ 75 degrees C

**10Gbps SFP+ (10G Ethernet/10GBASE)**

Model	Speed (Mbps)	Connector Interface	Fiber Mode	Distance	Wavelength (nm)	Operating Temp.
MTB-SR	10G	LC	Multi Mode	Up to 300m	850nm	0 ~ 60 degrees C
MTB-LR	10G	LC	Single Mode	10km	1310nm	0 ~ 60 degrees C

**10Gbps SFP+ (10GBASE-BX, Single Fiber Bi-directional SFP)**

Model	Speed (Mbps)	Connector Interface	Fiber Mode	Distance	Wavelength (TX)	Wavelength (RX)	Operating Temp.
MTB-LA20	10G	WDM(LC)	Single Mode	20km	1270nm	1330nm	0 ~ 60 degrees C
MTB-LB20	10G	WDM(LC)	Single Mode	20km	1330nm	1270nm	0 ~ 60 degrees C
MTB-LA40	10G	WDM(LC)	Single Mode	40km	1270nm	1330nm	0 ~ 60 degrees C
MTB-LB40	10G	WDM(LC)	Single Mode	40km	1330nm	1270nm	0 ~ 60 degrees C
MTB-LA60	10G	WDM(LC)	Single Mode	60km	1270nm	1330nm	0 ~ 60 degrees C
MTB-LB60	10G	WDM(LC)	Single Mode	60km	1330nm	1270nm	0 ~ 60 degrees C



It is recommended to use PLANET SFP/SFP+ on the Managed Switch. If you insert an SFP/SFP+ transceiver that is not supported, the Managed Switch will not recognize it.

1. Before we connect the SGS-6341 series to the other network device, we have to make sure both sides of the SFP transceivers are with the same media type, for example: 1000BASE-SX to 1000BASE-SX, 1000Bas-LX to 1000BASE-LX.
2. Check whether the fiber-optic cable type matches with the SFP transceiver requirement.
  - To connect to 1000BASE-SX SFP transceiver, please use the multi-mode fiber cable with one side being the male duplex LC connector type.
  - To connect to 1000BASE-LX SFP transceiver, please use the single-mode fiber cable with one side being the male duplex LC connector type.

■ **Connect the Fiber Cable**

1. Insert the duplex LC connector into the SFP/SFP+ transceiver.
2. Connect the other end of the cable to a device with SFP/SFP+ transceiver installed.
3. Check the LNK/ACT LED of the SFP/SFP+ slot on the front of the Managed Switch. Ensure that the SFP/SFP+ transceiver is operating correctly.
4. Check the Link mode of the SFP/SFP+ port if the link fails. To function with some fiber-NICs or Media Converters, user has to set the port Link mode to “10G Force”, “1000M Force” or “100M Force”.

■ **Remove the Transceiver Module**

1. Make sure there is no network activity anymore.
2. Remove the Fiber-Optic Cable gently.
3. Lift up the lever of the MGB module and turn it to a horizontal position.
4. Pull out the module gently through the lever.

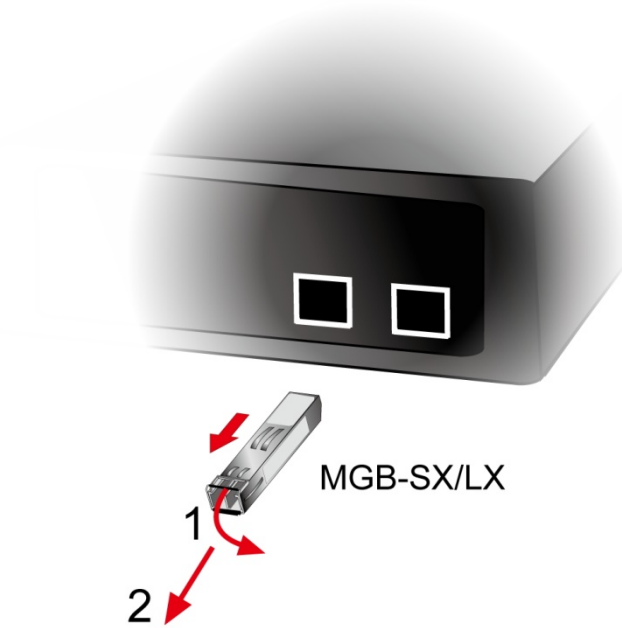

**Figure 2-17:** How to Pull Out the SFP/SFP+ Transceiver



Never pull out the module without lifting up the lever of the module and turning it to a horizontal position. Directly pulling out the module could damage the module and the SFP/SFP+ module slot of the Managed Switch.

# Chapter 3 Switch Management

## 3.1 Management Options

After purchasing the switch, the user needs to configure the switch for network management. Switch provides two management options: in-band management and out-of-band management.

### 3.1.1 Out-Of-Band Management

Out-of-band management is the management through Console interface. Generally, the user will use out-of-band management for the initial switch configuration, or when in-band management is not available. For instance, the SGS-6341 series default IP address is 192.168.0.254 or the user can try to assign a new IP address to the switch via the Console interface to be able to access the switch through Telnet.

The procedures for managing the switch via Console interface are listed below:

#### Step 1: Setting up the environment:

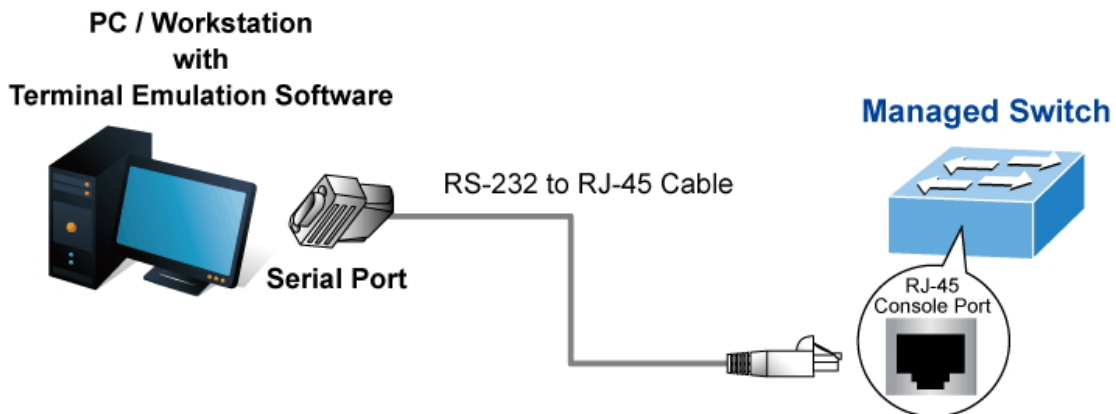

Figure 3-1 Out-of-band Management Configuration Environment

As shown in the above, the serial port (RS232) is connected to the switch with the serial cable provided. The table below lists all the devices used in the connection.

Device Name	Description
PC machine	Has functional keyboard and RS232, with terminal emulator installed, such as Tera Term and hyper terminal.
Serial port cable	One end is connected to the RS232 serial port; the other end to the console port.
Switch	Functional console port required.

### Step 2 : Entering the HyperTerminal

Open the HyperTerminal included in Windows after the connection is established. The example below is based on the HyperTerminal included in Windows XP.

- 1) Click Start menu - All Programs -Accessories -Communication - **HyperTerminal**.

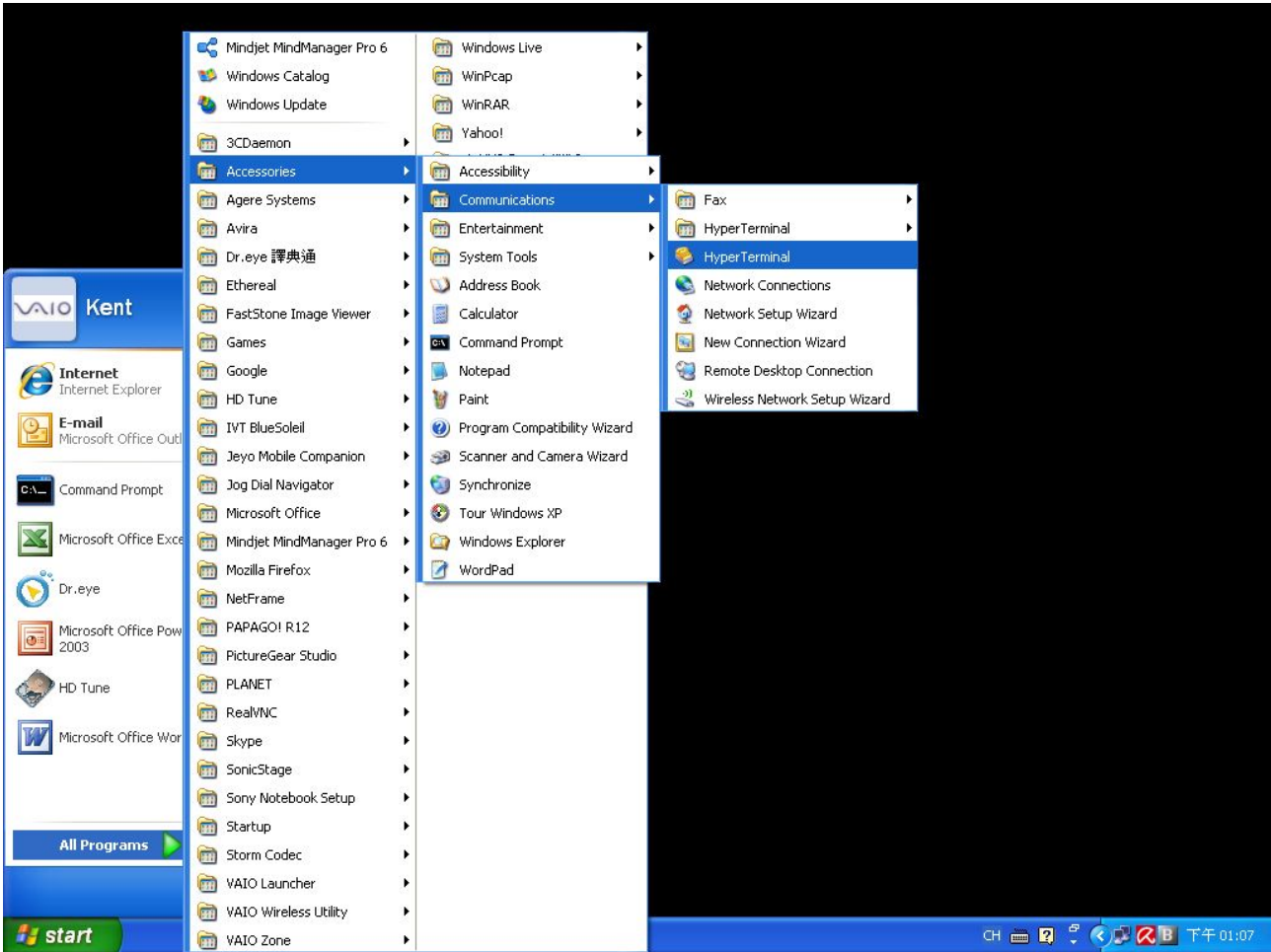

Figure 3-2 Opening Hyper Terminal

- 2) Type a name for opening HyperTerminal, such as “Switch”.



Figure 3-3 Opening HyperTerminal

- 3) In the "Connecting using" field, select the RS232 serial port used by the PC, e.g. COM1, and click "OK".



**Figure 3-4** Opening HyperTerminal

- 4) COM1 property appears, select "115200" for "Baud rate", "8" for "Data bits", "none" for "Parity checksum", "1" for stop bit and "none" for traffic control; or, you can also click "Restore default" and click "OK".

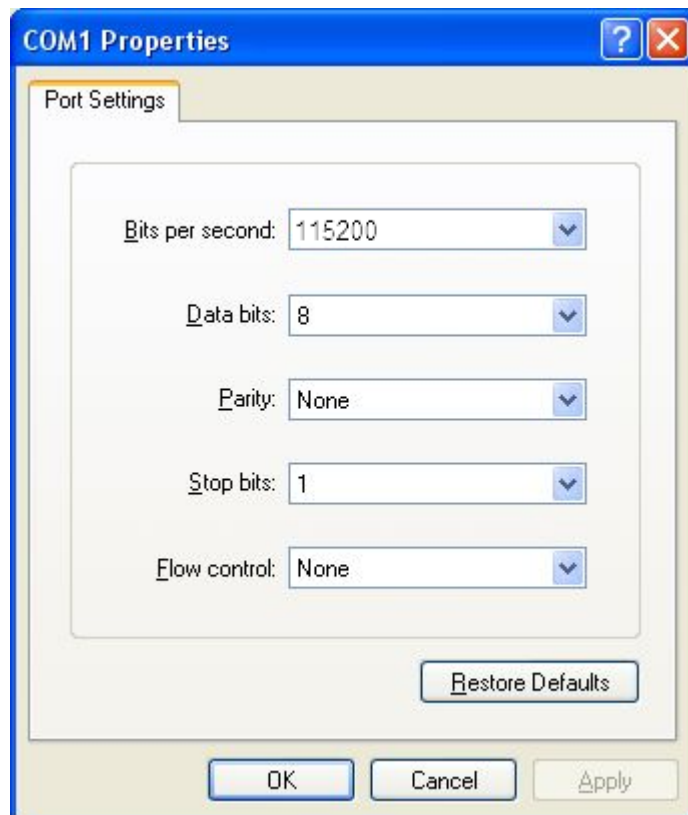

**Figure 3-5** Opening HyperTerminal

**Step 3:** Entering switch CLI interface

Power on the switch, the following appears in the HyperTerminal windows, that is the CLI configuration mode for Switch.

```
Testing RAM...
0x077C0000 RAM OK
Loading MiniBootROM...
Attaching to file system ...

Loading nos.img ... done.
Booting.....
Starting at 0x10000...

Attaching to file system ...
.....
--- Performing Power-On Self Tests (POST) ---
DRAM Test.....PASS!
PCI Device 1 Test.....PASS!
FLASH Test.....PASS!
FAN Test.....PASS!
Done All Pass.
----- DONE -----
Current time is SUN JAN 01 00:00:00 2006
.....
Switch>
```

The user can now enter commands to manage the switch. For a detailed description for the commands, please refer to the following chapters.

### 3.1.2 In-band Management

In-band management refers to the management by login to the switch using Telnet, or using HTTP, or using SNMP management software to configure the switch. In-band management enables management of the switch for some devices attached to the switch. In the case when in-band management fails due to switch configuration changes, out-of-band management can be used for configuring and managing the switch.

#### 3.1.2.1 Management via Telnet

To manage the switch with Telnet, the following conditions should be met:

- 1) Switch has an IPv4/IPv6 address configured;
- 2) The host IP address (Telnet client) and the switch's VLAN interface IPv4/IPv6 address is in the same network segment;
- 3) If 2) is not met, Telnet client can connect to an IPv4/IPv6 address of the switch via other devices,

such as a router.

The switch is a Layer 3 switch that can be configured with several IPv4/IPv6 addresses, the configuration method refers to the relative chapter. The following example assumes the shipment status of the switch where only VLAN1 exists in the system.

The following describes the steps for a Telnet client to connect to the switch's VLAN1 interface by Telnet (IPV4 address for an example):

**Step 1: Configure the IP addresses for the switch and start the Telnet Server function on the switch.**

First is the configuration of host IP address. This should be within the same network segment as the switch VLAN1 interface IP address. Suppose the switch VLAN1 interface IP address is 10.1.128.251/24. Then, a possible host IP address is 10.1.128.252/24. Run "ping 10.1.128.251" from the host and verify the result, check for reasons if ping fails.

The IP address configuration commands for VLAN1 interface are listed below. Before in-band management, the switch must be configured with an IP address by out-of-band management (i.e. Console mode), the configuration commands are as follows (All switch configuration prompts are assumed to be "Switch" hereafter if not otherwise specified):

```
Switch>
Switch>enable
Switch#config
Switch(config)#interface vlan 1
Switch(Config-if-Vlan1)#ip address 10.1.128.251 255.255.255.0
Switch(Config-if-Vlan1)#no shutdown
```

To enable the Telnet Server function, users should type the CLI command telnet-server enable in the global mode shown below:

```
Switch>en
Switch#config
Switch(config)# telnet-server enable
```

**Step 2: Run Telnet Client program.**

Run Telnet client program includes in Windows with the specified Telnet target.



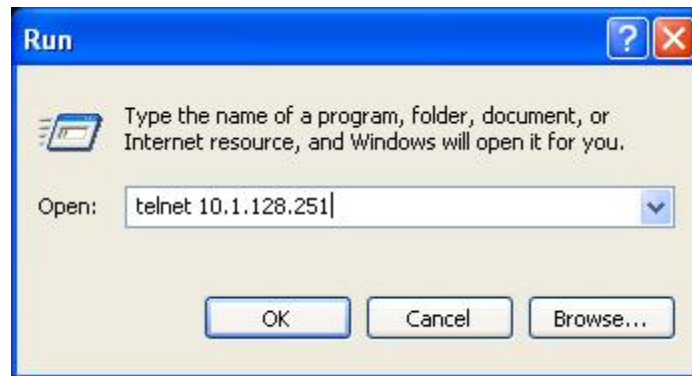

Figure 3-7 Run telnet client program included in Windows

### Step 3: Login to the switch.

Login to the Telnet configuration interface. Valid login name and password are required, otherwise the switch will reject Telnet access. This is a method to protect the switch from unauthorized access. As a result, when Telnet is enabled for configuring and managing the switch, username and password for authorized Telnet users must be configured with the following command:

```
username <username> privilege <privilege> [password (0|7) <password>].
```

To open the local authentication style with the following command: authentication line vty login local. Privilege option must exist and just is 15. Assume an authorized user in the switch has a username of "test", and password of "test", the configuration procedure should like the following:

```
Switch>enable  
Switch#config  
Switch(config)#username test privilege 15 password 0 test  
Switch(config)#authentication line vty login local
```

Enter valid login name and password in the Telnet configuration interface. Telnet user will be able to enter the switch's CLI configuration interface. The command used in the Telnet CLI interface after login is the same as that in the Console interface.

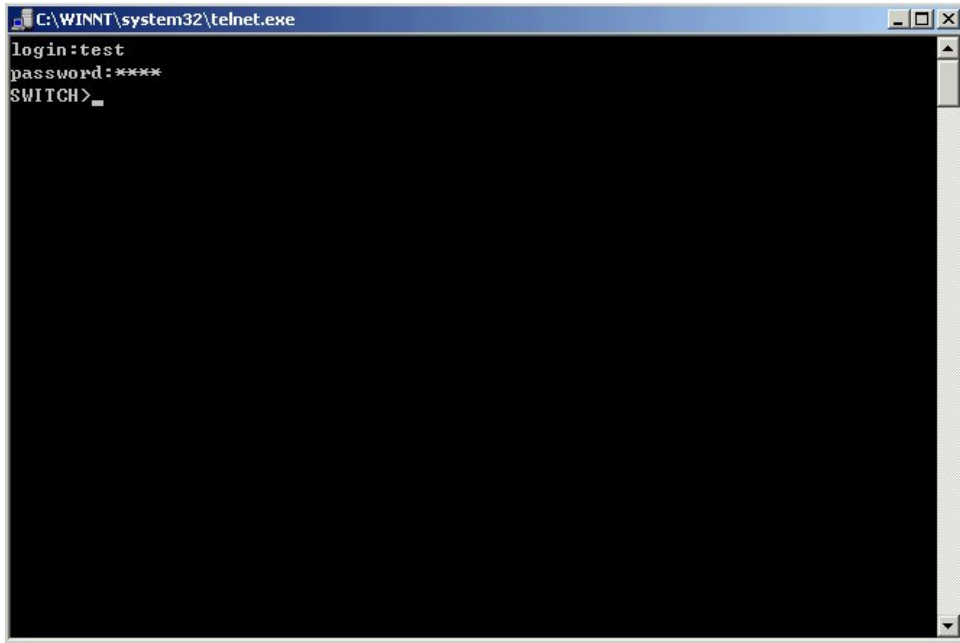

**Figure 3-8** Telnet Configuration Interface

### 3.1.2.2 Management via HTTP

To manage the switch via HTTP, the following conditions should be met:

- 1) Switch has an IPv4/IPv6 address configured;
- 2) The host IPv4/IPv6 address (HTTP client) and the switch's VLAN interface IPv4/IPv6 address are in the same network segment;
- 3) If 2) is not met, HTTP client should connect to an IPv4/IPv6 address of the switch via other devices, such as a router.

Similar to management the switch via Telnet, as soon as the host succeeds to ping/ping6 an IPv4/IPv6 address of the switch and to type the right login password, it can access the switch via HTTP. The configuration list is shown below:

**Step 1:** Run HTTP protocol on the host.

Open the Web browser on the host and type the IP address of the switch, or run directly the HTTP protocol on the Windows. For example, the IP address of the switch is "10.1.128.251";

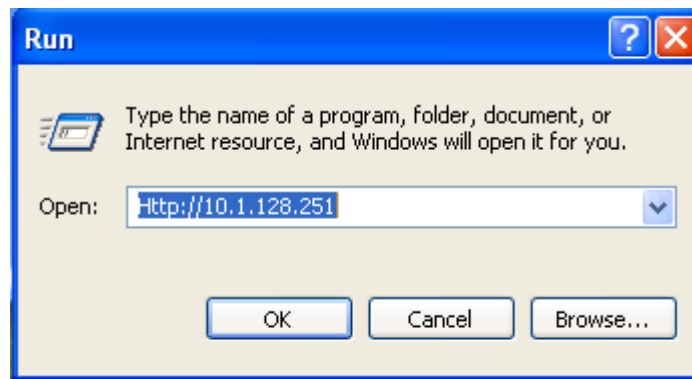

Figure 3-9 Run HTTP Protocol

When accessing a switch with IPv6 address, it is recommended to use the Firefox browser with 1.5 or later version. For example, if the IPv6 address of the switch is 3ffe:506:1:2::3. Input the IPv6 address of the switch is [http://\[3ffe:506:1:2::3\]](http://[3ffe:506:1:2::3]) and the address should draw together with the square brackets.

**Step 2:** Login to the switch.

Login to the Web configuration interface. Valid login name and password are required, otherwise the switch will reject HTTP access. This is a method to protect the switch from unauthorized access. As a result, when Telnet is enabled for configuring and managing the switch, username and password for authorized Telnet users must be configured with the following command:

```
username <username> privilege <privilege> [password (0|7) <password>]
```

To open the local authentication style with the following command: **authentication line web login local**. **Privilege** option must exist and just is 15. Assume an authorized user in the switch has a username of "admin", and password of "admin", the configuration procedure should like the following:

```
Switch>enable
Switch#config
Switch(config)#username admin privilege 15 password 0 admin
Switch(config)#authentication line web login local
```

The Web login interface of SGS-6341-24T4X, SGS-6341-48T4X and SGS-6341-24P4X is shown below:

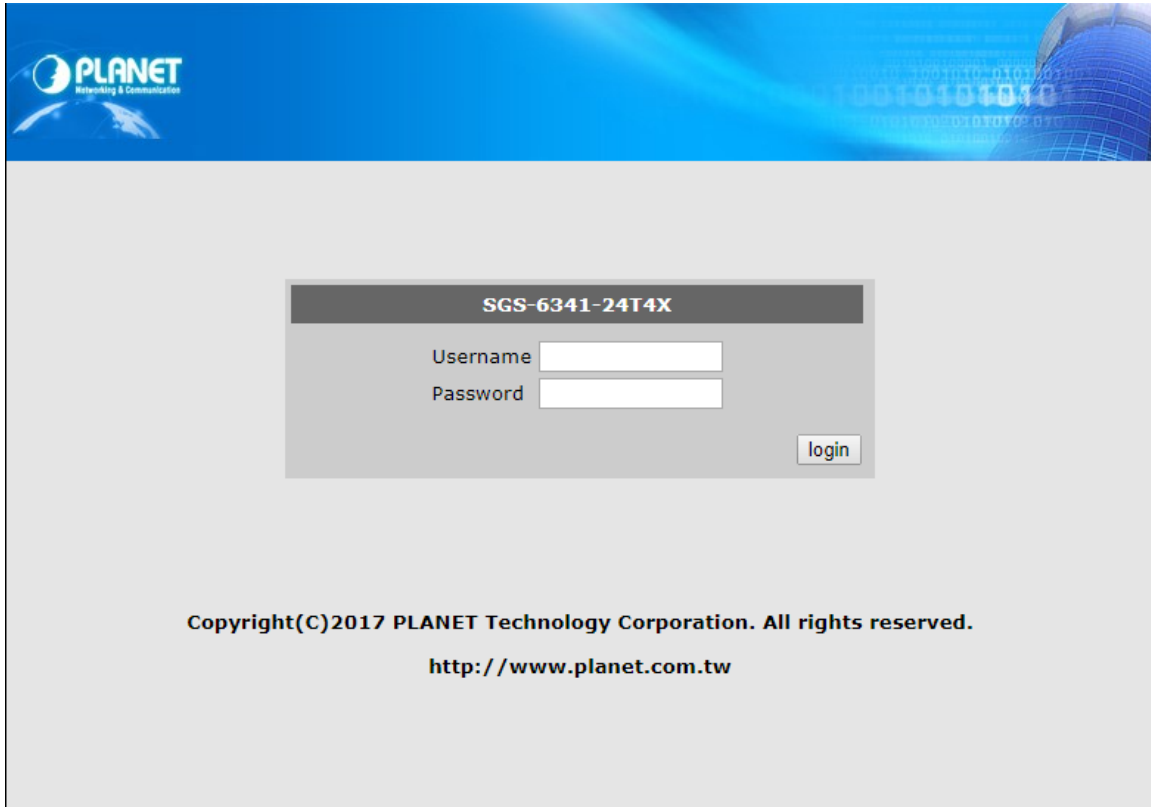

Figure 3-10 Web Login Interface

Input the right username and password, and then the main Web configuration interface is shown below.

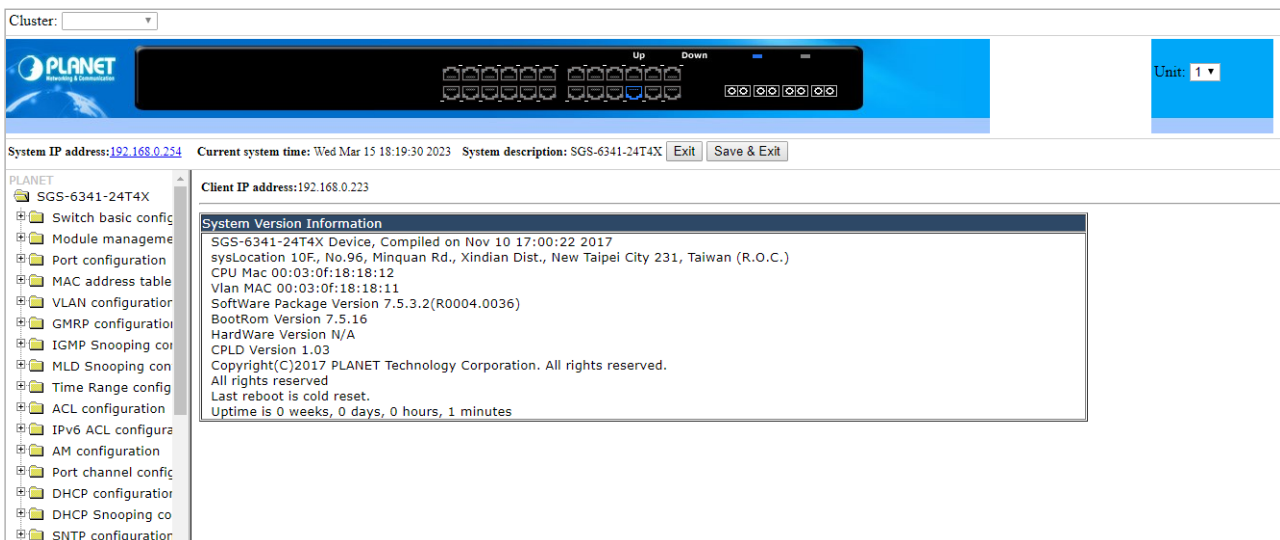

Figure 3-11 Main Web Configuration Interface



Note

When configuring the switch, the name of the switch is composed of English letters.

### 3.1.2.3 Managing the Switch via SNMP Network Management Software

The necessities required by SNMP network management software to manage switches are:

- 1) IP addresses are configured on the switch;
- 2) The IP address of the client host and that of the VLAN interface on the switch it subordinates to should be in the same segment;
- 3) If 2) is not met, the client should be able to reach an IP address of the switch through devices like routers;
- 4) SNMP should be enabled.

The host with SNMP network management software should be able to ping the IP address of the switch, so that, when running, SNMP network management software will be able to find it and implement read/write operation on it. Details about how to manage switches via SNMP network management software will not be covered in this manual, please refer to “SNMP network management software user manual”.

### 3.2 CLI Interface

The switch provides these management interfaces for users: CLI (Command Line Interface) interface, Web interface and SNMP network management software. We will introduce the CLI interface and Web configuration interface in details. Web interface is familiar with CLI interface function and will not be covered. Please refer to “SNMP network management software user manual”.

CLI interface is familiar to most users. As aforementioned, out-of-band management and Telnet login are all performed through CLI interface to manage the switch.

CLI Interface is supported by Shell program, which consists of a set of configuration commands. Those commands are categorized according to their functions in switch configuration and management. Each category represents a different configuration mode. The Shell for the switch is described below:

- Configuration modes
- Configuration syntax
- Shortcut keys
- Help function
- Input verification
- Fuzzy match support

#### 3.2.1 Configuration Modes

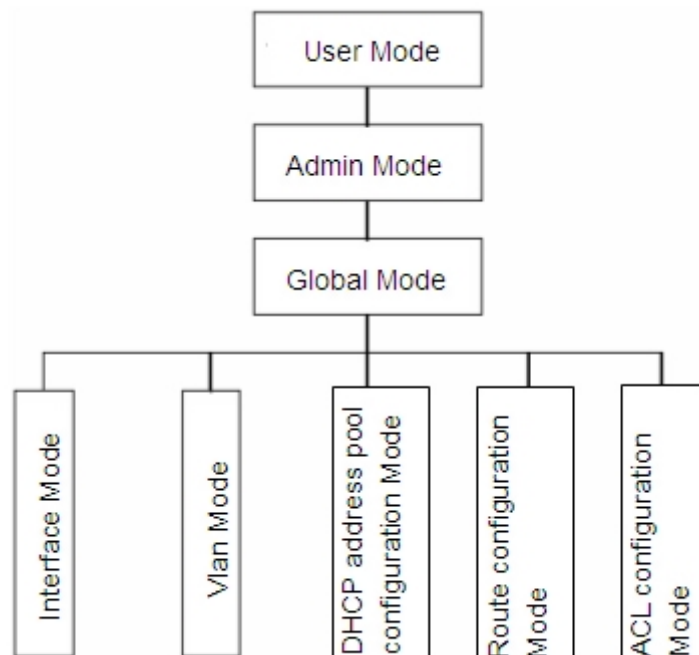

Figure 3-12 Shell Configuration Modes

### 3.2.1.1 User Mode

On entering the CLI interface, enter user entry system first. If as common user, it is defaulted to User Mode. The prompt shown is “**Switch>**”, the symbol “>” is the prompt for User Mode. When exit command is run in Admin Mode, it will also return to the User Mode.

In User Mode, no configuration to the switch is allowed, only clock time and version information of the switch can be queried.

### 3.2.1.2 Admin Mode

In Admin Mode sees the following: In user entry system, if as Admin user, it is defaulted to Admin Mode. Admin Mode prompt “**Switch#**” can be entered in the User Mode by running the enable command and entering corresponding access levels admin user password, if a password has been set. Or, when exit command is run in Global Mode, it will also return to the Admin Mode. The switch also provides a shortcut key sequence “**Ctrl+z**”; this allows an easy way to exit to Admin Mode from any configuration mode (except User Mode).

In Admin Mode, the user can query the switch configuration information, connection status and traffic statistics of all ports; and the user can further enter the Global Mode from Admin Mode to modify all configurations of the switch. For this reason, a password must be set for entering Admin mode to prevent unauthorized access and malicious modification to the switch.

### 3.2.1.3 Global Mode

Type the config command in Admin Mode to enter the Global Mode prompt “**Switch(config)#**”. Use the exit command in other configuration modes such as Port Mode and VLAN mode to return to Global Mode.

The user can perform global configuration settings in Global Mode, such as MAC Table, Port Mirroring, VLAN creation, IGMP Snooping start and STP, etc. And the user can go further to Port Mode for configuration of all the interfaces.

#### ■ Interface Mode

Use the interface command in Global Mode to enter the interface mode specified. The switch provides three interface types: 1. VLAN interface, 2. Ethernet port and 3. Port-channel.

Interface Type	Entry	Operates	Exit
VLAN Interface	Type <b>interface vlan &lt;Vlan-id&gt;</b> command in Global Mode.	Configure switch IPs, etc	Use the <b>exit</b> command to return to Global Mode.
Ethernet Port	Type <b>interface ethernet &lt;interface-list&gt;</b> command in Global Mode.	Configure supported duplex mode, speed, etc. of Ethernet Port.	Use the <b>exit</b> command to return to Global Mode.
Port-channel	Type <b>interface port-channel &lt;port-channel-number&gt;</b> command in Global Mode.	Configure port-channel related settings such as duplex mode, speed, etc.	Use the <b>exit</b> command to return to Global Mode.

■ **VLAN Mode**

Use the **vlan <vlan-id>** command in Global Mode to enter the corresponding VLAN Mode. In VLAN Mode the user can configure all member ports of the corresponding VLAN. Run the exit command to exit the VLAN Mode to Global Mode.

■ **DHCP Address Pool Mode**

Type the **ip dhcp pool <name>** command in Global Mode to enter the DHCP Address Pool Mode prompt "Switch(Config-<name>-dhcp)#". DHCP address pool properties can be configured in DHCP Address Pool Mode. Run the exit command to exit the DHCP Address Pool Mode to Global Mode.

■ **Route Mode**

Routing Protocol	Entry	Operation	Exit
RIP Routing Protocol	Type <b>router rip</b> command in Global Mode.	Configure RIP protocol parameters.	Use the <b>exit</b> command to return to Global Mode.
OSPF Routing Protocol	Type <b>router ospf</b> command in Global Mode.	Configure OSPF protocol parameters.	Use the <b>exit</b> command to return to Global Mode.
BGP Routing Protocol	Type <b>router bgp &lt;AS number&gt;</b> command in Global Mode.	Configure BGP protocol parameters.	Use the <b>exit</b> command to return to Global Mode.

■ **ACL Mode**

ACL type	Entry	Operation	Exit
Standard IP ACL Mode	Type <b>ip access-list standard</b> command in Global Mode.	Configure parameters for Standard IP ACL Mode.	Use the <b>exit</b> command to return to Global Mode.
Extended IP ACL Mode	Type <b>ip access-list extended</b> command in Global Mode.	Configure parameters for Extended IP ACL Mode.	Use the <b>exit</b> command to return to Global Mode.

### 3.2.2 Configuration Syntax

The switch provides various configuration commands. Although all the commands are different, they all abide by the syntax for Switch configuration commands. The general commands format of Switch is shown below:

**cmdtxt <variable> {enum1 | ... | enumN} [option1 | ... | optionN]**

Conventions: **cmdtxt** in bold font indicates a command keyword; **<variable>** indicates a variable parameter; **{enum1 | ... | enumN}** indicates a mandatory parameter that should be selected from the parameter set **enum1~enumN**; and the square bracket ([ ]) in **[option1 | ... | optionN]** indicate an optional parameter. There may be combinations of "< >", "{ }" and "[ ]" in the command line, such as **[<variable>], {enum1 <variable>| enum2}, [option1 [option2]]**, etc.



Here are examples for some actual configuration commands:

- `show version`, no parameters required. This is a command with only a keyword and no parameter, just type in the command to run.
- `vlan <vlan-id>`, parameter values are required after the keyword.
- `firewall {enable | disable}`, user can enter `firewall enable` or `firewall disable` for this command.
- `snmp-server community {ro | rw} <string>`, the followings are possible:
  - `snmp-server community ro <string>`
  - `snmp-server community rw <string>`

### 3.2.3 Shortcut Key Support

The switch provides several shortcut keys to facilitate user configuration, such as up, down, left, right and Blank Space. If the terminal does not recognize Up and Down keys, **ctrl +p** and **ctrl +n** can be used instead.

Key(s)	Function	
<b>Back Space</b>	Delete a character before the cursor, and the cursor moves back.	
<b>Up “↑”</b>	Show previous command entered. Up to ten recently entered commands can be shown.	
<b>Down “↓”</b>	Show next command entered. When use the Up key to get previously entered commands, you can use the Down key to return to the next command	
<b>Left “←”</b>	The cursor moves one character to the left.	You can use the Left and Right key to modify an entered command.
<b>Right “→”</b>	The cursor moves one character to the right.	
<b>Ctrl +p</b>	The same as Up key “↑”.	
<b>Ctrl +n</b>	The same as Down key “↓”.	
<b>Ctrl +b</b>	The same as Left key “←”.	
<b>Ctrl +f</b>	The same as Right key “→”.	
<b>Ctrl +z</b>	Return to the Admin Mode directly from the other configuration modes (except User Mode).	
<b>Ctrl +c</b>	Break the ongoing command process, such as ping or other command execution.	
<b>Tab</b>	When a string for a command or keyword is entered, the Tab can be used to complete the command or keyword if there is no conflict.	

### 3.2.4 Help Function

There are two ways in the switch for the user to access help information: the “help” command and the “?”.

Access to Help	Usage and function
<b>Help</b>	Under any command line prompt, type in “help” and press Enter will get a brief description of the associated help system.
<b>“?”</b>	<ol style="list-style-type: none"> <li>1 · Under any command line prompt, enter “?” to get a command list of the current mode and related brief description.</li> <li>2 · Enter a “?” after the command keyword with a embedded space. If the position should be a parameter, a description of that parameter type, scope, etc, will be returned; if the position should be a keyword, then a set of keywords with brief description will be returned; if the output is “&lt;cr&gt;”, then the command is complete, press Enter to run the command.</li> <li>3 · A “?” immediately following a string. This will display all the commands that begin with that string.</li> </ol>

### 3.2.5 Input Verification

#### 3.2.5.1 Returned Information: successful

All commands entered through keyboards undergo syntax check by the Shell. Nothing will be returned if the user entered a correct command in corresponding modes and the execution is successful.

#### Returned Information: error

Output error message	Explanation
Unrecognized command or illegal parameter!	The entered command does not exist, or there is an error in parameter scope, type or format.
Ambiguous command	At least two interpretations are possible based on the current input.
Invalid command or parameter	The command is recognized, but no valid parameter record is found.
This command does not exist in current mode	The command is recognized, but this command cannot be used in current mode.
Please configure precursor command "*" at first!	The command is recognized, but the prerequisite command has not been configured.
syntax error : missing "" before the end of command line!	Quotation marks are not used in pairs.

### 3.2.6 Fuzzy Match Support

Switch shell supports fuzzy match in searching command and keyword. Shell will recognize commands or keywords correctly if the entered string causes no conflict.

For example:

- 1) For command "show interfaces status ethernet1/1", typing "sh in status ethernet1/1" will work.
- 2) However, for command "**show running-config**", the system will report a "> Ambiguous command!" error if only "show r" is entered, as Shell is unable to tell whether it is "show run" or "show running-config". Therefore, Shell will only recognize the command if "sh ru" is entered.

---

# Chapter 4 Basic Switch Configuration

## 4.1 Basic Configuration

Basic switch configuration includes commands for entering and exiting the admin mode, entering and exiting interface mode, configuring and displaying the switch clock, displaying the version information of the switch system, etc.

Command	Explanation
Normal User Mode/ Admin Mode	
<b>enable</b> <b>disable</b>	The User uses <b>enable</b> command to step into admin mode from normal user mode. The <b>disable</b> command is for exiting admin mode.
Admin Mode	
<b>config [terminal]</b>	Enter global mode from admin mode.
Various Modes	
<b>exit</b>	Exit current mode and enter previous mode, such as using this command in global mode to go back to admin mode, and back to normal user mode from admin mode.
Except User Mode/ Admin Mode	
<b>end</b>	Quit current mode and return to Admin mode when not in User Mode/ Admin Mode.
Admin Mode	
<b>clock set &lt;HH:MM:SS&gt;</b> <b>[YYYY.MM.DD]</b>	Set system date and time.
<b>show version</b>	Display version information of the switch.
<b>set default</b>	Restore to the factory default.
<b>write</b>	Save current configuration parameters to Flash Memory.
<b>reload</b>	Hot reset the switch.
<b>show cpu usage</b>	Show CPU usage rate.
<b>show memory usage</b>	Show memory usage rate.
Global Mode	
<b>banner motd &lt;LINE&gt;</b> <b>no banner motd</b>	Configure the information displayed when the login authentication of a telnet or console user is successful.

---

## 4.2 Telnet Management

### 4.2.1 Telnet

#### 4.2.1.1 Introduction to Telnet

Telnet is a simple remote terminal protocol for remote login. Using Telnet, the user can login to a remote host with its IP address or hostname from his own workstation. Telnet can send the user's keystrokes to the remote host and send the remote host output to the user's screen through TCP connection. This is a transparent service, as to the user, the keyboard and monitor seems to be connected to the remote host directly. Telnet employs the Client-Server mode, the local system is the Telnet client and the remote host is the Telnet server. Switch can be either the Telnet Server or the Telnet client.

When switch is used as the Telnet server, the user can use the Telnet client program included in Windows or the other operation systems to login to switch, as described earlier in the In-band management section. As a Telnet server, switch allows up to 5 telnet client TCP connections.

And as Telnet client, using telnet command under Admin Mode allows the user to login to the other remote hosts. Switch can only establish TCP connection to one remote host. If a connection to another remote host is desired, the current TCP connection must be dropped.

#### 4.2.1.2 Telnet Configuration Task List

1. Configuring Telnet Server
2. Telnet to a remote host from the switch.

##### 1. Configuration of Telnet Server

Command	Explanation
Global Mode	
<b>telnet-server enable</b> <b>no telnet-server enable</b>	Enable the Telnet server function in the switch: the “ <b>no telnet-server enable</b> ” command disables the Telnet function.
<b>username &lt;user-name&gt; [privilege &lt;privilege&gt;] [password {0   7} &lt;password&gt;]</b> <b>no username &lt;username&gt;</b>	Configure user name and password of the telnet. The <b>no</b> form command deletes the telnet user authorization.
<b>authentication securityip &lt;ip-addr&gt;</b> <b>no authentication securityip &lt;ip-addr&gt;</b>	Configure the secure IP address to login to the switch through Telnet: the <b>no</b> command deletes the authorized Telnet secure address.
<b>authentication securityipv6 &lt;ipv6-addr&gt;</b>	Configure the secure IPv6 address to login to the

<b>no authentication securityipv6 &lt;ipv6-addr&gt;</b>	switch through Telnet: the no command deletes the authorized Telnet secure address.
<b>authentication ip access-class {&lt;num-std&gt; &lt;name&gt;}</b> <b>no authentication ip access-class</b>	Binding standard IP ACL protocol to login with Telnet/SSH/Web; the no form command will cancel the binding ACL.
<b>authentication ipv6 access-class {&lt;num-std&gt; &lt;name&gt;}</b> <b>no authentication ipv6 access-class</b>	Binding standard IPv6 ACL protocol to login with Telnet/SSH/Web; the no form command will cancel the binding ACL.
<b>authentication line {console   vty   web} login {local   radius   tacacs }</b> <b>no authentication line {console   vty   web} login</b>	Configure telnet authentication mode.
Admin Mode	
<b>terminal monitor</b> <b>terminal no monitor</b>	Display debug information for Telnet client login to the switch; the <b>no</b> command disables the debug information.

## 2. Telnet to a remote host from the switch

Command	Explanation
Admin Mode	
<b>telnet {&lt;ip-addr&gt;   &lt;ipv6-addr&gt; /host &lt;hostname&gt;} [&lt;port&gt;]</b>	Login to a remote host with the Telnet client included in the switch.

## 4.2.2 SSH

### 4.2.2.1 Introduction to SSH

**SSH (Secure Shell)** is a protocol which ensures a secure remote access connection to network devices. It is based on the reliable TCP/IP protocol. By conducting the mechanism such as key distribution, authentication and encryption between SSH server and SSH client, a secure connection is established. The information transferred on this connection is protected from being intercepted and decrypted. The switch meets the requirements of SSH2.0. It supports SSH2.0 client software such as SSH Secure Client and putty. Users can run the above software to manage the switch remotely.

The switch presently supports **RSA authentication, 3DES cryptography** protocol and SSH user password authentication, etc.

## 4.2.2.2 SSH Server Configuration Task List

### SSH Server Configuration

Command	Explanation
Global Mode	
<b>ssh-server enable</b> <b>no ssh-server enable</b>	Enable SSH function on the switch; the “ <b>no ssh-server enable</b> ” command disables SSH function.
<b>ssh-user &lt;user-name&gt; password {0   7} &lt;password&gt;</b> <b>no ssh-user &lt;user-name&gt;</b>	Configure the username and password of SSH client software for logging on the switch; the “ <b>no ssh-user &lt;user-name&gt;</b> ” command deletes the username.
<b>ssh-server timeout &lt;timeout&gt;</b> <b>no ssh-server timeout</b>	Configure timeout value for SSH authentication; the “ <b>no ssh-server timeout</b> ” command restores the default timeout value for SSH authentication.
<b>ssh-server authentication-retries &lt;authentication-retries&gt;</b> <b>no ssh-server authentication-retries</b>	Configure the number of times for retrying SSH authentication; the “ <b>no ssh-server authentication-retries</b> ” command restores the default number of times for retrying SSH authentication.
<b>ssh-server host-key create rsa modulus &lt;modulus&gt;</b>	Generate the new RSA host key on the SSH server.
Admin Mode	
<b>terminal monitor</b> <b>terminal no monitor</b>	Display SSH debug information on the SSH client side; the “ <b>no terminal monitor</b> ” command stops displaying SSH debug information on the SSH client side.

## 4.2.2.3 Typical SSH Server Configuration

### Example 1:

Requirement: Enable SSH server on the switch, and run SSH2.0 client software such as secure shell client or putty on the terminal. Log on to the switch by using the username and password from the client.

Configure the IP address, add SSH user and enable SSH service on the switch. SSH2.0 client can log on to the switch by using the username and password to configure the switch.

```
Switch(config)#ssh-server enable
Switch(config)#interface vlan 1
Switch(Config-if-Vlan1)#ip address 100.100.100.200 255.255.255.0
```

```
Switch(Config-if-Vlan1)#exit
Switch(config)#ssh-user test password 0 test
```

In IPv6 networks, the terminal should run IPv6-supported SSH client software, such as putty6. Users should make no modification to configurations on the switch except allocating an IPv6 address for the local host.

## 4.3 Configuration of Switch IP Addresses

All Ethernet ports of switch are default to Data Link layer ports and perform layer 2 forwarding. VLAN interface represents a Layer 3 interface function which can be assigned an IP address, which is also the IP address of the switch. All VLAN interfaces related configuration commands can be configured in VLAN Mode. Switch provides three IP address configuration methods:

- Manual
- BOOTP
- DHCP

Manual configuration of IP address is assigned manually for the switch.

In BOOTP/DHCP mode, the switch operates as a BOOTP/DHCP client, send broadcast packets of BOOTPRequest to the BOOTP/DHCP servers, and the BOOTP/DHCP servers assign the address on receiving the request. In addition, switch can act as a DHCP server, and dynamically assign network parameters such as IP addresses, gateway addresses and DNS server addresses to DHCP clients DHCP Server configuration is detailed in later chapters.

### 4.3.1 Switch IP Addresses Configuration Task List

- 1 · Enable VLAN port mode
- 2 · Manual configuration
- 3 · BOOTP configuration
- 4 · DHCP configuration

#### 1. Enable VLAN port mode

Command	Explanation
Global Mode	
<b>interface vlan &lt;vlan-id&gt;</b> <b>no interface vlan &lt;vlan-id&gt;</b>	Create VLAN interface (layer 3 interface); the “ <b>no interface vlan &lt;vlan-id&gt;</b> ” command deletes the VLAN interface.

#### 2. Manual configuration

Command	Explanation
VLAN Port Mode	
<b>ip address &lt;ip_address&gt; &lt;mask&gt;</b>	Configure the VLAN interface IP address; the “ <b>no</b>



<b>[secondary]</b> <b>no ip address &lt;ip_address&gt; &lt;mask&gt;</b> <b>[secondary]</b>	<b>ip address &lt;ip_address&gt; &lt;mask&gt; [secondary]</b> command deletes VLAN interface IP address.
<b>ipv6 address &lt;ipv6-address / prefix-length&gt; [eui-64]</b> <b>no ipv6 address &lt;ipv6-address / prefix-length&gt;</b>	Configure IPv6 address, including aggregation global unicast address, local site address and local link address. The <b>no</b> form command deletes IPv6 address.

### 3. BOOTP configuration

Command	Explanation
VLAN Port Mode	
<b>ip bootp-client enable</b> <b>no ip bootp-client enable</b>	Enable the switch to be a BootP client and obtain IP address and gateway address through BootP negotiation; the “ <b>no ip bootp-client enable</b> ” command disables the BootP client function.

### 4. DHCP configuration

Command	Explanation
VLAN Port Mode	
<b>ip bootp-client enable</b> <b>no ip bootp-client enable</b>	Enable the switch to be a DHCP client and obtain IP address and gateway address through DHCP negotiation; the “ <b>no ip bootp-client enable</b> ” command disables the DHCP client function.

## 4.4 SNMP Configuration

### 4.4.1 Introduction to SNMP

**SNMP (Simple Network Management Protocol)** is a standard network management protocol widely used in computer network management. SNMP is an evolving protocol. SNMP v1 [RFC1157] is the first version of SNMP which is adapted by vast numbers of manufacturers for its simplicity and easy implementation; SNMP v2c is an enhanced version of SNMP v1, which supports layered network management; SNMP v3 strengthens the security by adding **USM (User-based Security Mode)** and **VACM (View-based Access Control Model)**.

SNMP protocol provides a simple way of exchange network management information between two points in the network. SNMP employs a polling mechanism of message query, and transmits messages through UDP (a connectionless transport layer protocol). Therefore it is well supported by the existing computer networks.

SNMP protocol employs a station-agent mode. There are two parts in this structure: **NMS (Network Management Station)** and Agent. NMS is the workstation on which SNMP client program is running. It is the core on the SNMP network management. Agent is the server software runs on the devices which need to be managed. NMS manages all the managed objects through Agents. The switch supports Agent function.

---

The communication between NMS and Agent functions in Client/Server mode by exchanging standard messages. NMS sends request and the Agent responds. There are seven types of SNMP message:

- Get-Request
- Get-Response
- Get-Next-Request
- Get-Bulk-Request
- Set-Request
- Trap
- Inform-Request

**NMS** sends queries to the Agent with Get-Request, Get-Next-Request, Get-Bulk-Request and Set-Request messages; and the Agent, upon receiving the requests, replies with Get-Response message. On some special situations, like network device ports are on Up/Down status or the network topology changes, Agents can send Trap messages to NMS to inform the abnormal events. Besides, NMS can also be set to alert to some abnormal events by enabling RMON function. When alert events are triggered, Agents will send Trap messages or log the event according to the settings. Inform-Request is mainly used for inter-NMS communication in the layered network management.

**USM** ensures the transfer security by well-designed encryption and authentication. USM encrypts the messages according to the user typed password. This mechanism ensures that the messages can't be viewed on transmission. And USM authentication ensures that the messages can't be changed on transmission. USM employs **DES-CBC** cryptography. And **HMAC-MD5** and **HMAC-SHA** are used for authentication.

**VACM** is used to classify the users' access permission. It puts the users with the same access permission in the same group. Users can't conduct the operation which is not authorized.

## 4.4.2 Introduction to MIB

The network management information accessed by NMS is well defined and organized in a **Management Information Base (MIB)**. MIB is pre-defined information which can be accessed by network management protocols. It is in layered and structured form. The pre-defined management information can be obtained from monitored network devices. ISO ASN.1 defines a tree structure for MID. Each MIB organizes all the available information with this tree structure. And each node on this tree contains an **OID (Object Identifier)** and a brief description about the node. OID is a set of integers divided by periods. It identifies the node and can be used to locate the node in a MID tree structure, shown in the figure below:

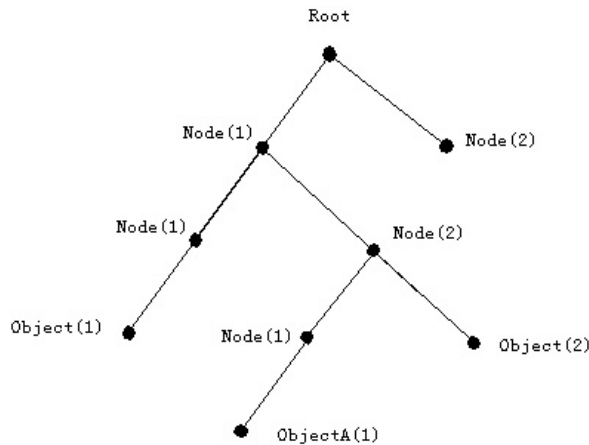

**Figure 4-1 ASN.1 Tree Instance**

In this figure, the OID of the object A is 1.2.1.1. NMS can locate this object through this unique OID and gets the standard variables of the object. MIB defines a set of standard variables for monitored network devices by following this structure.

If the variable information of Agent MIB needs to be browsed, the MIB browse software needs to be run on the NMS. MIB in the Agent usually consists of public MIB and private MIB. The public MIB contains public network management information that can be accessed by all NMS; private MIB contains specific information which can be viewed and controlled by the support of the manufacturers.

MIB-I [RFC1156] is the first implemented public MIB of SNMP, and is replaced by MIB-II [RFC1213]. MIB-II expands MIB-I and keeps the OID of MIB tree in MIB-I. MIB-II contains sub-trees which are called groups. Objects in those groups cover all the functional domains in network management. NMS obtains the network management information by visiting the MIB of SNMP Agent.

The switch can operate as a SNMP Agent, and supports both SNMP v1/v2c and SNMP v3. The switch supports basic MIB-II, RMON public MIB and other public MID such as BRIDGE MIB. Besides, the switch supports self-defined private MIB.

### 4.4.3 Introduction to RMON

RMON is the most important expansion of the standard SNMP. RMON is a set of MIB definitions, used to define standard network monitor functions and interfaces, enabling the communication between SNMP management terminals and remote monitors. RMON provides a highly efficient method to monitor actions inside the subnets.

MID of RMON consists of 10 groups. The switch supports the most frequently used group 1, 2, 3 and 9:

- **Statistics:** Maintain basic usage and error statistics for each subnet monitored by the Agent.
- **History:** Record periodical statistic samples available from Statistics.
- **Alarm:** Allow management console users to set any count or integer for sample intervals and alert thresholds for RMON Agent records.
- **Event:** A list of all events generated by RMON Agent.

Alarm depends on the implementation of Event. Statistics and History display some current or history subnet statistics. Alarm and Event provide a method to monitor any integer data change in the network, and provide some alerts upon abnormal events (sending Trap or record in logs).

## 4.4.4 SNMP Configuration

### 4.4.4.1 SNMP Configuration Task List

1. Enable or disable SNMP Agent server function
2. Configure SNMP community string
3. Configure IP address of SNMP management base
4. Configure engine ID
5. Configure user
6. Configure group
7. Configure view
8. Configuring TRAP
9. Enable/Disable RMON

#### 1. Enable or disable SNMP Agent server function

Command	Explanation
Global Mode	
<b>snmp-server enabled</b> <b>no snmp-server enabled</b>	Enable the SNMP Agent function on the switch; the no command disables the SNMP Agent function on the switch.

#### 2. Configure SNMP community string

Command	Explanation
Global Mode	
<b>snmp-server community {ro rw} &lt;string&gt;</b> <b>[access {&lt;num-std&gt; &lt;name&gt;}]</b> <b>[ipv6-access</b> <b>{&lt;ipv6-num-std&gt; &lt;ipv6-name&gt;}] [read</b> <b>&lt;read-view-name&gt;] [write</b> <b>&lt;write-view-name&gt;]</b> <b>no snmp-server community &lt;string&gt;</b> <b>[access {&lt;num-std&gt; &lt;name&gt;}]</b> <b>[ipv6-access</b> <b>{&lt;ipv6-num-std&gt; &lt;ipv6-name&gt;}]</b>	Configure the community string for the switch; the no command deletes the configured community string.

### 3. Configure IP address of SNMP management base

Command	Explanation
Global Mode	
<b>snmp-server securityip { &lt;ipv4-addr&gt; / &lt;ipv6-addr&gt; }</b> <b>no snmp-server securityip { &lt;ipv4-addr&gt; / &lt;ipv6-addr&gt; }</b>	Configure the secure IPv4/IPv6 address which is allowed to access the switch on the NMS; the no command deletes configured secure address.
<b>snmp-server securityip enable</b> <b>snmp-server securityip disable</b>	Enable or disable secure IP address check function on the NMS.

### 4. Configure engine ID

Command	Explanation
Global Mode	
<b>snmp-server engineid &lt;engine-string&gt;</b> <b>no snmp-server engineid</b>	Configure the local engine ID on the switch. This command is used for SNMP v3.

### 5. Configure user

Command	Explanation
Global Mode	
<b>snmp-server user &lt;use-string&gt; &lt;group-string&gt;</b> <b>[[authPriv   authNoPriv] auth {md5   sha}</b> <b>&lt;word&gt;] [access {&lt;num-std&gt; &lt;name&gt;}]</b> <b>[ipv6-access {&lt;ipv6-num-std&gt; &lt;ipv6-name&gt;}]</b> <b>no snmp-server user &lt;user-string&gt; [access</b> <b>{&lt;num-std&gt; &lt;name&gt;}] [ipv6-access</b> <b>{&lt;ipv6-num-std&gt; &lt;ipv6-name&gt;}]</b>	Add a user to a SNMP group. This command is used to configure USM for SNMP v3.

### 6. Configure group

Command	Explanation
Global Mode	
<b>snmp-server group &lt;group-string&gt;</b> <b>{noauthnopriv authnopriv authpriv} [[read</b> <b>&lt;read-string&gt;] [write &lt;write-string&gt;] [notify</b> <b>&lt;notify-string&gt;]] [access</b> <b>{&lt;num-std&gt; &lt;name&gt;}] [ipv6-access</b> <b>{&lt;ipv6-num-std&gt; &lt;ipv6-name&gt;}]</b> <b>no snmp-server group &lt;group-string&gt;</b> <b>{noauthnopriv authnopriv authpriv}</b> <b>[access {&lt;num-std&gt; &lt;name&gt;}]</b> <b>[ipv6-access</b> <b>{&lt;ipv6-num-std&gt; &lt;ipv6-name&gt;}]</b>	Set the group information on the switch. This command is used to configure VACM for SNMP v3.

## 7. Configure view

Command	Explanation
Global Mode	
<b>snmp-server view &lt;view-string&gt; &lt;oid-string&gt; {include exclude} no snmp-server view &lt;view-string&gt;[&lt;oid-string&gt;]</b>	Configure view on the switch. This command is used for SNMP v3.

## 8. Configuring TRAP

Command	Explanation
Global Mode	
<b>snmp-server enable traps no snmp-server enable traps</b>	Enable the switch to send Trap message. This command is used for SNMP v1/v2/v3.
<b>snmp-server host { &lt;ipv4-addr&gt;   &lt;ipv6-addr&gt; } {v1   v2c   {v3 {noauthnopriv /authnopriv   authpriv}}} &lt;user-string&gt; no snmp-server host { &lt;ipv4-addr&gt;   &lt;ipv6-addr&gt; } {v1   v2c   {v3 {noauthnopriv /authnopriv   authpriv}}} &lt;user-string&gt;</b>	Set the host IPv4/IPv6 address which is used to receive SNMP Trap information. For SNMP v1/v2, this command also configures Trap community string; for SNMP v3, this command also configures Trap user name and security level. The “no” form of this command cancels this IPv4 or IPv6 address.

## 9. Enable/Disable RMON

Command	Explanation
Global mode	
<b>rmon enable no rmon enable</b>	Enable/disable RMON.

## 4.4.5 Typical SNMP Configuration Examples

The IP address of the NMS is 1.1.1.5; the IP address of the switch (Agent) is 1.1.1.9.

**Scenario 1:** The NMS network administrative software uses SNMP protocol to obtain data from the switch.

The configuration on the switch is listed below:

```
Switch(config)#snmp-server enable
Switch(config)#snmp-server community rw private
Switch(config)#snmp-server community ro public
Switch(config)#snmp-server securityip 1.1.1.5
```

The NMS can use private as the community string to access the switch with read-write permission, or use public as the community string to access the switch with read-only permission.

---

**Scenario 2:** NMS will receive Trap messages from the switch (Note: NMS may have community string verification for the Trap messages. In this scenario, the NMS uses a Trap verification community string of usertrap).

The configuration on the switch is listed below:

```
Switch(config)#snmp-server enable
Switch(config)#snmp-server host 1.1.1.5 v1 usertrap
Switch(config)#snmp-server enable traps
```

**Scenario 3:** NMS uses SNMP v3 to obtain information from the switch.

The configuration on the switch is listed below:

```
Switch(config)#snmp-server
Switch(config)#snmp-server user tester UserGroup authPriv auth md5 hellotst
Switch(config)#snmp-server group UserGroup AuthPriv read max write max notify max
Switch(config)#snmp-server view max 1 include
```

**Scenario 4:** NMS wants to receive the v3Trap messages sent by the switch.

The configuration on the switch is listed below:

```
Switch(config)#snmp-server enable
Switch(config)#snmp-server host 10.1.1.2 v3 authpriv tester
Switch(config)#snmp-server enable traps
```

**Scenario 5:** The IPv6 address of the NMS is 2004:1:2:3::2; the IPv6 address of the switch (Agent) is 2004:1:2:3::1. The NMS network administrative software uses SNMP protocol to obtain data from the switch.

The configuration on the switch is listed below:

```
Switch(config)#snmp-server enable
Switch(config)#snmp-server community rw private
Switch(config)#snmp-server community ro public
Switch(config)#snmp-server securityip 2004:1:2:3::2
```

The NMS can use private as the community string to access the switch with read-write permission, or use public as the community string to access the switch with read-only permission.

**Scenario 6:** NMS will receive Trap messages from the switch (Note: NMS may have community string verification for the Trap messages. In this scenario, the NMS uses a Trap verification community string of dcstrap).

The configuration on the switch is listed below:

```
Switch(config)#snmp-server host 2004:1:2:3::2 v1 dcstrap
Switch(config)#snmp-server enable traps
```

## 4.4.6 SNMP Troubleshooting

When users configure the SNMP, the SNMP server may fail to run properly due to physical connection failure and wrong configuration, etc. Users can troubleshoot the problems by following the guide below:

- Good condition of the physical connection.
  - Interface and datalink layer protocol is Up (use the “show interface” command), and the connection between the switch and host can be verified by ping (use “ping” command).
  - The switch enabled SNMP Agent server function (use “snmp-server” command)
  - Secure IP for NMS (use “snmp-server securityip” command) and community string (use “snmp-server community” command) are correctly configured, as any of them fails, SNMP will not be able to communicate with NMS properly.
  - If Trap function is required, remember to enable Trap (use “snmp-server enable traps” command). And remember to properly configure the target host IP address and community string for Trap (use “snmp-server host” command) to ensure Trap message can be sent to the specified host.
  - If RMON function is required, RMON must be enabled first (use “rmon enable” command).
  - Use “show snmp” command to verify sent and received SNMP messages; Use “show snmp status” command to verify SNMP configuration information; Use “debug snmp packet” to enable SNMP debugging function and verify debug information.
- If users still can't solve the SNMP problems, Please contact our technical and service center.

## 4.5 Switch Upgrade

Switch provides two ways for switch upgrade: BootROM upgrade and the TFTP/FTP upgrade under Shell.

### 4.5.1 Switch System Files

The system files includes system image file and boot file. The updating of the switch is to update the two files by overwrite the old files with the new ones.

The system image files refers to the compressed files of the switch hardware drivers, and software support program, etc, namely what we usually call the IMG update file. The IMG file can only be saved in the FLASH with a defined name of nos.img

The boot file is for initiating the switch, namely what we usually call the ROM update file (It can be compressed into IMG file if it is of large size). In switch, the boot file is allowed to save in ROM only. Switch mandates the path and the name of two boot files to be flash:/boot.rom and flash:/config.rom.

The update method of the system image file and the boot file is the same. The switch supplies the user with two modes of updating: 1. BootROM mode; 2. TFTP and FTP update at Shell mode. This two update method will be explained in details in following two sections.



---

## 4.5.2 BootROM Upgrade

There are two methods for BootROM upgrade: TFTP and FTP, which can be selected at BootROM command settings.

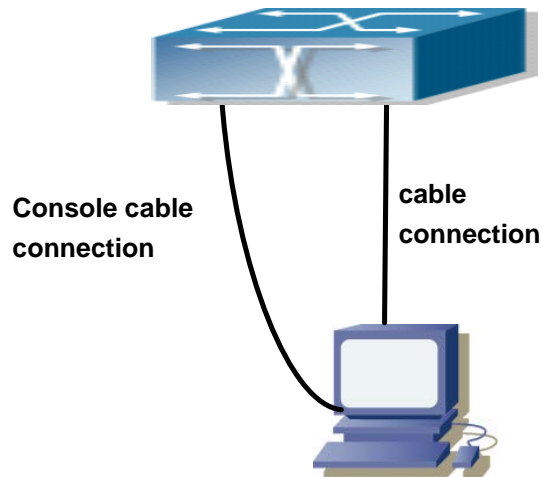

**Figure 4-2** Typical topology for switch upgrade in BootROM mode

The upgrade procedures are listed below:

### Step 1:

As shown in the figure, a PC is used as the console for the switch. A console cable is used to connect PC to the management port on the switch. The PC should have FTP/TFTP server software installed and has the image file required for the upgrade.

### Step 2:

Press "ctrl+b" on switch boot up until the switch enters BootROM monitor mode. The operation result is shown below:

```
[Boot]:
```

### Step 3:

Under BootROM mode, run "setconfig" to set the IP address and mask of the switch under BootROM mode, server IP address and mask, and select TFTP or FTP upgrade. Suppose the switch address is 192.168.1.2, and PC address is 192.168.1.66, and select TFTP upgrade, the configuration should like:

```
[Boot]: setconfig
Host IP Address: [10.1.1.1] 192.168.1.2
Server IP Address: [10.1.1.2] 192.168.1.66
FTP(1) or TFTP(2): [1] 2
Network interface configure OK.
[Boot]
```

---

**Step 4:**

Enable FTP/TFTP server in the PC. For TFTP, run TFTP server program; for FTP, run FTP server program. Before start downloading upgrade file to the switch, verify the connectivity between the server and the switch by ping from the server. If ping succeeds, run “load” command in the BootROM mode from the switch; if it fails, perform troubleshooting to find out the cause. The following is the configuration for the system update image file.

```
[Boot]: load nos.img
Loading...

Loading file ok!
```

**Step 5:**

Execute write nos.img in BootROM mode. The following saves the system update image file.

```
[Boot]: write nos.img
File nos.img exists, overwrite? (Y/N)?[N] y
Writing nos.img.....
Write nos.img OK.
[Boot]:
```

**Step 6:**

The following update file boot.rom, the basic environment is the same as Step 4.

```
[Boot]: load boot.rom
Loading...

Loading file ok!
```

**Step 7:**

Execute write boot.rom in BootROM mode. The following saves the update file.

```
[Boot]: write boot.rom

File boot.rom exists, overwrite? (Y/N)?[N] y

Writing boot.rom.....
Write boot.rom OK.
[Boot]:
```

---

**Step 8:**

The following update file config.rom, the basic environment is the same as Step 4.

```
[Boot]: load config.rom
Loading...

Loading file ok!
```

**Step 9:**

Execute **write flash:/config.rom** in BootROM mode. The following saves the update file.

```
[Boot]: write flash:/config.rom
[Boot]: write flash:/config.rom
File exists, overwrite? (Y/N)[N] y

Writing flash:/config.rom...
Write flash:/config.rom OK.
[Boot]:
```

**Step 10:**

After successful upgrade, execute run or reboot command in BootROM mode to return to CLI configuration interface.

```
[Boot]: run ( or reboot )
```

**Other commands in BootROM mode****1. DIR command**

Used to list existing files in the FLASH.

```
[Boot]: dir
config.rom                405,664 1980-01-01 00:00:00 --SH
boot.rom                  2,608,352 1980-01-01 00:00:00 --SH
boot.conf                 256 1980-01-01 00:00:00 ----
nos.img                   8,071,910 1980-01-01 00:00:00 ----
startup.cfg               1,590 1980-01-01 00:00:00 ----
```

---

## 4.5.3 FTP/TFTP Upgrade

### 4.5.3.1 Introduction to FTP/TFTP

FTP(File Transfer Protocol)/TFTP(Trivial File Transfer Protocol) are both file transfer protocols that belonging to fourth layer(application layer) of the TCP/IP protocol stack, used for transferring files between hosts, hosts and switches. Both of them transfer files in a client-server model. Their differences are listed below.

FTP builds upon TCP to provide reliable connection-oriented data stream transfer service. However, it does not provide file access authorization and uses simple authentication mechanism (transfers username and password in plain text for authentication). When using FTP to transfer files, two connections need to be established between the client and the server: a management connection and a data connection. A transfer request should be sent by the FTP client to establish management connection on port 21 in the server, and negotiate a data connection through the management connection.

There are two types of data connections: active connection and passive connection.

In active connection, the client transmits its address and port number for data transmission to the server, the management connection maintains until data transfer is complete. Then, using the address and port number provided by the client, the server establishes data connection on port 20 (if not engaged) to transfer data; if port 20 is engaged, the server automatically generates some other port number to establish data connection. In passive connection, the client, through management connection, notify the server to establish a passive connection. The server then creates its own data listening port and informs the client about the port, and the client establishes data connection to the specified port.

As data connection is established through the specified address and port, there is a third party to provide data connection service.

TFTP builds upon UDP, providing unreliable data stream transfer service with no user authentication or permission-based file access authorization. It ensures correct data transmission by sending and acknowledging mechanism and retransmission of time-out packets. The advantage of TFTP over FTP is that it is a simple and low overhead file transfer service.

Switch can operate as either FTP/TFTP client or server. When switch operates as a FTP/TFTP client, configuration files or system files can be downloaded from the remote FTP/TFTP servers (can be hosts or other switches) without affecting its normal operation. And file list can also be retrieved from the server in ftp client mode. Of course, switch can also upload current configuration files or system files to the remote FTP/TFTP servers (can be hosts or other switches). When switch operates as a FTP/TFTP server, it can provide file upload and download service for authorized FTP/TFTP clients, as file list service as FTP server.

Here are some terms frequently used in FTP/TFTP.

- **ROM:** Short for EPROM, erasable read-only memory. EPROM is replaced by FLASH memory in switch.
- **SDRAM:** RAM memory in the switch, used for system software operation and configuration sequence storage.
- **FLASH:** Flash memory used to save system file and configuration file.

- 
- **System file:** including system image file and boot file.
  - **System image file:** refers to the compressed file for switch hardware driver and software support program, usually refer to as IMAGE upgrade file. In switch, the system image file is allowed to save in FLASH only. Switch mandates the name of system image file to be uploaded via FTP in Global Mode to be nos.img, other IMAGE system files will be rejected.
  - **Boot file:** refers to the file initializes the switch, also referred to as the ROM upgrade file (Large size file can be compressed as IMAGE file). In switch, the boot file is allowed to save in ROM only. Switch mandates the name of the boot file to be boot.rom.
  - **Configuration file:** including start up configuration file and running configuration file. The distinction between start up configuration file and running configuration file can facilitate the backup and update of the configurations.
  - **Start up configuration file:** refers to the configuration sequence used in switch start up. Switch start up configuration file stores in FLASH only, corresponding to the so called configuration save. To prevent illicit file upload and easier configuration, switch mandates the name of start up configuration file to be startup-config.
  - **Running configuration file:** refers to the running configuration sequence use in the switch. In switch, the running configuration file stores in the RAM. In the current version, the running configuration sequence running-config can be saved from the RAM to FLASH by **write** command or **copy running-config startup-config** command, so that the running configuration sequence becomes the start up configuration file, which is called configuration save. To prevent illicit file upload and easier configuration, switch mandates the name of running configuration file to be running-config.
  - **Factory configuration file:** The configuration file shipped with switch in the name of factory-config. Run set default and write, and restart the switch, factory configuration file will be loaded to overwrite current start up configuration file.

### 4.5.3.2 FTP/TFTP Configuration

The configurations of switch as FTP and TFTP clients are almost the same, so the configuration procedures for FTP and TFTP are described together in this manual.

#### 4.5.3.2.1 FTP/TFTP Configuration Task List

1. FTP/TFTP client configuration
  - (1) Upload/download the configuration file or system file.
  - (2) For FTP client, server file list can be checked.
2. FTP server configuration
  - (1) Start FTP server
  - (2) Configure FTP login username and password

- (3) Modify FTP server connection idle time
- (4) Shut down FTP server

### 3. TFTP server configuration

- (1) Start TFTP server
- (2) Configure TFTP server connection idle time
- (3) Configure retransmission times before timeout for packets without acknowledgement
- (4) Shut down TFTP server

### 1. FTP/TFTP client configuration

- (1) FTP/TFTP client upload/download file

Command	Explanation
Admin Mode	
<b>copy &lt;source-url&gt; &lt;destination-url&gt; [ascii   binary]</b>	FTP/TFTP client upload/download file.

- (2) For FTP client, server file list can be checked.

Admin Mode	
<b>ftp-dir &lt;ftpServerUrl&gt;</b>	For FTP client, server file list can be checked. FtpServerUrl format looks like: ftp://user: password@IPv4 IPv6 Address.

### 2. FTP server configuration

- (1) Start FTP server

Command	Explanation
Global Mode	
<b>ftp-server enable no ftp-server enable</b>	Start FTP server and support IPv4, IPv6, the no command shuts down FTP server and prevents FTP user from logging in.

- (2) Configure FTP login username and password

Command	Explanation
Global Mode	
<b>ip ftp username &lt;username&gt; {nopassword   password {0   7} &lt;password&gt;} no ip ftp username&lt;username&gt;</b>	Configure FTP login username and password; this no command will delete the username and password.

---

(3) Modify FTP server connection idle time

Command	Explanation
Global Mode	
<b>ftp-server timeout &lt;seconds&gt;</b>	Set connection idle time.

### 3. TFTP server configuration

(1) Start TFTP server

Command	Explanation
Global Mode	
<b>tftp-server enable</b> <b>no tftp-server enable</b>	Start TFTP server, the no command shuts down TFTP server and prevents TFTP user from logging in.

(2) Modify TFTP server connection idle time

Command	Explanation
Global Mode	
<b>tftp-server retransmission-timeout &lt;seconds&gt;</b>	Set maximum retransmission time within timeout interval.

(3) Modify TFTP server connection retransmission time

Command	Explanation
Global Mode	
<b>tftp-server retransmission-number &lt;number&gt;</b>	Set the retransmission time for TFTP server.

### 4.5.3.3 FTP/TFTP Configuration Examples

It is the same configuration switch for IPv4 addresses and IPv6 addresses. The example only for the IPv4 addresses configuration.

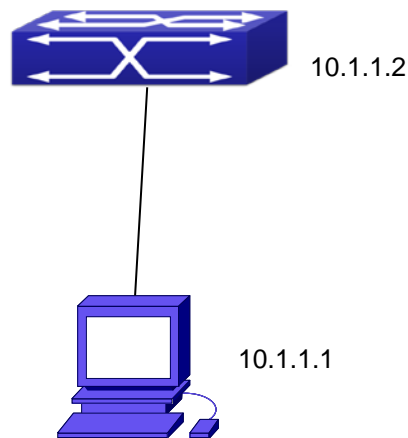

**Figure 4-3** Download nos.img file as FTP/TFTP client

**Scenario 1:** The switch is used as FTP/TFTP client. The switch connects from one of its ports to a computer, which is a FTP/TFTP server with an IP address of 10.1.1.1; the switch acts as a FTP/TFTP client, the IP address of the switch management VLAN is 10.1.1.2. Download “nos.img” file in the computer to the switch.

■ FTP Configuration

Computer side configuration:

Start the FTP server software on the computer and set the username “Switch”, and the password “switch”. Place the “12\_30\_nos.img” file to the appropriate FTP server directory on the computer.

The configuration procedures of the switch are listed below:

```
Switch(config)#interface vlan 1
Switch(Config-if-Vlan1)#ip address 10.1.1.2 255.255.255.0
Switch(Config-if-Vlan1)#no shut
Switch(Config-if-Vlan1)#exit
Switch(config)#exit
Switch#copy ftp: //Switch:switch@10.1.1.1/12_30_nos.img nos.img
```

With the above commands, the switch will have the “nos.img” file in the computer downloaded to the FLASH.

■ TFTP Configuration

Computer side configuration:

Start TFTP server software on the computer and place the “nos.img” file to the appropriate TFTP server directory on the computer.



---

The configuration procedures of the switch are listed below:

```
Switch(config)#interface vlan 1
Switch(Config-if-Vlan1)#ip address 10.1.1.2 255.255.255.0
Switch(Config-if-Vlan1)#no shut
Switch(Config-if-Vlan1)#exit
Switch(config)#exit
Switch#copy tftp: //10.1.1.1/12_30_nos.img nos.img
```

**Scenario 2:** The switch is used as FTP server. The switch operates as the FTP server and connects from one of its ports to a computer, which is a FTP client. Transfer the “nos.img” file in the switch to the computer and save as 12\_25\_nos.img.

The configuration procedures of the switch are listed below:

```
Switch(config)#interface vlan 1
Switch(Config-if-Vlan1)#ip address 10.1.1.2 255.255.255.0
Switch(Config-if-Vlan1)#no shut
Switch(Config-if-Vlan1)#exit
Switch(config)#ftp-server enable
Switch(config)# username Admin password 0 switch
```

Computer side configuration:

Login to the switch with any FTP client software, with the username “Switch” and password “superuser”, use the command “get nos.img 12\_25\_nos.img” to download “nos.img” file from the switch to the computer.

**Scenario 3:** The switch is used as TFTP server. The switch operates as the TFTP server and connects from one of its ports to a computer, which is a TFTP client. Transfer the “nos.img” file in the switch to the computer. The configuration procedures of the switch are listed below:

```
Switch(config)#interface vlan 1
Switch(Config-if-Vlan1)#ip address 10.1.1.2 255.255.255.0
Switch(Config-if-Vlan1)#no shut
Switch(Config-if-Vlan1)#exit
Switch(config)#tftp-server enable
Computer side configuration:
```

Login to the switch with any TFTP client software, use the “tftp” command to download “nos.img” file from the switch to the computer.

**Scenario 4:** Switch acts as FTP client to view file list on the FTP server.

Synchronization conditions: The switch connects to a computer by an Ethernet port, the computer is a FTP server with an IP address of 10.1.1.1; the switch acts as a FTP client, and the IP address of the switch management VLAN1 interface is 10.1.1.2.

---

■ FTP Configuration

PC side:

Start the FTP server software on the PC and set the username "Switch", and the password "Admin".

Switch:

```
Switch(config)#interface vlan 1
Switch(Config-if-Vlan1)#ip address 10.1.1.2 255.255.255.0
Switch(Config-if-Vlan1)#no shut
Switch(Config-if-Vlan1)#exit
Switch#copy ftp://Switch: superuser@10.1.1.1
220 Serv-U FTP-Server v2.5 build 6 for WinSock ready...
331 User name okay, need password.
230 User logged in, proceed.
200 PORT Command successful.
150 Opening ASCII mode data connection for /bin/ls.
recv total = 480
nos.img
nos.rom
parsecommandline.cpp
position.doc
qmdict.zip
...(some display omitted here)
show.txt
snmp.TXT
226 Transfer complete.
```

---

## 4.5.3.4 FTP/TFTP Troubleshooting

### 4.5.3.4.1 FTP Troubleshooting

When upload/download system file with FTP protocol, the connectivity of the link must be ensured, i.e., use the “Ping” command to verify the connectivity between the FTP client and server before running the FTP program. If ping fails, you will need to check for appropriate troubleshooting information to recover the link connectivity.

- The following is what the message displays when files are successfully transferred. Otherwise, please verify link connectivity and retry “copy” command again.

```
220 Serv-U FTP-Server v2.5 build 6 for WinSock ready...
331 User name okay, need password.
230 User logged in, proceed.
200 PORT Command successful.
nos.img file length = 1526021
read file ok
send file
150 Opening ASCII mode data connection for nos.img.
226 Transfer complete.
close ftp client.
```

- The following is the message displays when files are successfully received. Otherwise, please verify link connectivity and retry “copy” command again.

```
220 Serv-U FTP-Server v2.5 build 6 for WinSock ready...
331 User name okay, need password.
230 User logged in, proceed.
200 PORT Command successful.
rcv total = 1526037
*****
write ok
150 Opening ASCII mode data connection for nos.img (1526037 bytes).
226 Transfer complete.
```

- If the switch is upgrading system file or system start up file through FTP, the switch must not be restarted until “close ftp client” or “226 Transfer complete.” is displayed, indicating upgrade is successful, otherwise the switch may be rendered unable to start. If the system file and system start up file upgrade through FTP fails, please try to upgrade again or use the BootROM mode to upgrade.

---

### 4.5.3.4.2 TFTP Troubleshooting

When upload/download system file with TFTP protocol, the connectivity of the link must be ensured, i.e., use the “**Ping**” command to verify the connectivity between the TFTP client and server before running the TFTP program. If ping fails, you will need to check for appropriate troubleshooting information to recover the link connectivity.

- The following is the message displays when files are successfully transferred. Otherwise, please verify link connectivity and retry “copy” command again.

```
nos.img file length = 1526021
read file ok
begin to send file, wait...
file transfers complete.
Close tftp client.
```

- The following is the message displays when files are successfully received. Otherwise, please verify link connectivity and retry “copy” command again.

```
begin to receive file, wait...
recv 1526037
*****
write ok
transfer complete
close tftp client.
```

If the switch is upgrading system file or system start up file through TFTP, the switch must not be restarted until “close tftp client” is displayed, indicating upgrade is successful, otherwise the switch may be rendered unable to start. If the system file and system start up file upgrade through TFTP fails, please try upgrade again or use the BootROM mode to upgrade.

---

# Chapter 5 File System Operations

## 5.1 Introduction to File Storage Devices

File storage devices used in switches mainly include FLASH cards. As the most common storage device, FLASH is usually used to store system image files (IMG files), system boot files (ROM files) and system configuration files (CFG files).

Flash can copy, delete, or rename files under Shell or Bootrom mode.

## 5.2 File System Operation Configuration Task list

1. The formatting operation of storage devices
2. The creation of sub-directories
3. The deletion of sub-directory
4. Changing the current working directory of the storage device
5. The display operation of the current working directory
6. The display operation of information about a designated file or directory
7. The deletion of a designated file in the file system
8. The renaming operation of files
9. The copying operation of files

### 1. The formatting operation of storage devices

Command	Explanation
Admin Configuration Mode	
<b>format &lt;device&gt;</b>	Format the storage device.

### 2. The creation of sub-directories

Command	Explanation
Admin Configuration Mode	
<b>mkdir &lt;directory&gt;</b>	Create a sub-directory in a designated directory on a certain device.

### 3. The deletion of sub-directory

Command	Explanation
Admin Configuration Mode	
<b>rmdir &lt;directory&gt;</b>	Delete a sub-directory in a designated directory on a certain device.

#### 4. Changing the current working directory of the storage device

Command	Explanation
Admin Configuration Mode	
<b>cd &lt;directory&gt;</b>	Change the current working directory of the storage device.

#### 5. The display operation of the current working directory

Command	Explanation
Admin Configuration Mode	
<b>pwd</b>	Display the current working directory.

#### 6. The display operation of information about a designated file or directory

Command	Explanation
Admin Configuration Mode	
<b>dir [WORD]</b>	Display information about a designated file or directory on the storage device.

#### 7. The deletion of a designated file in the file system

Command	Explanation
Admin Configuration Mode	
<b>delete &lt;file-url&gt;</b>	Delete the designated file in the file system.

#### 8. The renaming operation of files

Command	Explanation
Admin Configuration Mode	
<b>rename &lt;source-file-url&gt; &lt;dest-file&gt;</b>	Change the name of a designated file on the switch to a new one.

#### 9. The copy operation of files

Command	Explanation
Admin Configuration Mode	
<b>copy &lt;source-file-url&gt; &lt;dest-file-url&gt;</b>	Copy a designated file one the switch and store it as a new one.

## 5.3 Typical Applications

Copy an IMG file flash:/nos.img stored in the FLASH on the boardcard, to cf:/nos-6.1.11.0.img.

The configuration of the switch is as follows:

```
Switch#copy flash:/nos.img flash:/nos-6.1.11.0.img
Copy flash:/nos.img to flash:/nos-6.1.11.0.img? [Y:N] y
Copied file flash:/nos.img to flash:/nos-6.1.11.0.img.
```

---

## 5.4 Troubleshooting

If errors occur when users try to implement file system operations, please check whether they are caused by the following reasons

- Whether file names or paths are entered correctly.
- When renaming a file, whether it is in use or the new file name is already used by an existing file or directory.

---

# Chapter 6 Cluster Configuration

## 6.1 Introduction to cluster network management

Cluster network management is an in-band configuration management. Unlike CLI, SNMP and Web Config which implement a direct management of the target switches through a management workstation, cluster network management implements a direct management of the target switches (member switches) through an intermediate switch (commander switch). A commander switch can manage multiple member switches. As soon as a Public IP address is configured in the commander switch, all the member switches which are configured with private IP addresses can be managed remotely. This feature economizes public IP addresses which are short of supply. Cluster network management can dynamically discover cluster feature enabled switches (candidate switches). Network administrators can statically or dynamically add the candidate switches to the cluster which is already established. Accordingly, they can configure and manage the member switches through the commander switch. When the member switches are distributed in various physical locations (such as on the different floors of the same building), cluster network management has obvious advantages. Moreover, cluster network management is an in-band management. The commander switch can communicate with member switches in existing network. There is no need to build a specific network for network management.

Cluster network management has the following features:

- Save IP addresses
- Simplify configuration tasks
- Indifference to network topology and distance limitation
- Auto detecting and auto establishing
- With factory default settings, multiple switches can be managed through cluster network management
- The commander switch can upgrade and configure any member switches in the cluster

## 6.2 Cluster Network Management Configuration Sequence

Cluster Network Management Configuration Sequence:

- 1 · Enable or disable cluster function
- 2 · Create cluster
  - 1) Configure private IP address pool for member switches of the cluster
  - 2) Create or delete cluster
  - 3) Add or remove a member switch
- 3 · Configure attributes of the cluster in the commander switch
  - 1) Enable or disable automatically adding cluster members
  - 2) Set automatically added members to manually added ones
  - 3) Set or modify the time interval of keep-alive messages on switches in the cluster.
  - 4) Set or modify the max number of lost keep-alive messages that can be tolerated



- 5) Clear the list of candidate switches maintained by the switch
- 4 · Configure attributes of the cluster in the candidate switch
  - 1) Set the time interval of keep-alive messages of the cluster
  - 2) Set the max number of lost keep-alive messages that can be tolerated in the cluster
- 5 · Remote cluster network management
  - 1) Remote configuration management
  - 2) Remotely upgrade member switch
  - 3) Reboot member switch
- 6 · Manage cluster network with web
  - 1) Enable http
- 7 · Manage cluster network with snmp
  - 1) Enable snmp server

### 1. Enable or disable cluster

Command	Explanation
Global Mode	
<b>cluster run [key &lt;WORD&gt;] [vid &lt;VID&gt;]</b> <b>no cluster run</b>	Enable or disable cluster function in the switch.

### 2. Create a cluster

Command	Explanation
Global Mode	
<b>cluster ip-pool &lt;commander-ip&gt;</b> <b>no cluster ip-pool</b>	Configure the private IP address pool for cluster member devices.
<b>cluster commander [&lt;cluster_name&gt;]</b> <b>no cluster commander</b>	Create or delete a cluster.
<b>cluster member {candidate-sn &lt;candidate-sn&gt;   mac-address &lt;mac-addr&gt; [id &lt;member-id&gt; ]}</b> <b>no cluster member {id &lt;member-id&gt;   mac-address &lt;mac-addr&gt;}</b>	Add or remove a member switch.

### 3. Configure attributes of the cluster in the commander switch

Command	Explanation
Global Mode	
<b>cluster auto-add</b> <b>no cluster auto-add</b>	Enable or disable adding newly discovered candidate switch to the cluster.
<b>cluster member auto-to-user</b>	Change automatically added members into manually added ones.
<b>cluster keepalive interval &lt;second&gt;</b> <b>no cluster keepalive interval</b>	Set the keep-alive interval of the cluster.

<b>cluster keepalive loss-count &lt;int&gt;</b> <b>no cluster keepalive loss-count</b>	Set the max number of lost keep-alive messages that can be tolerated in the cluster.
Admin mode	
<b>clear cluster nodes [nodes-sn &lt;candidate-sn-list&gt;   mac-address &lt;mac-addr&gt;]</b>	Clear nodes in the list of candidate switches maintained by the switch.

#### 4. Configure attributes of the cluster in the candidate switch

Command	Explanation
Global Mode	
<b>cluster keepalive interval &lt;second&gt;</b> <b>no cluster keepalive interval</b>	Set the keep-alive interval of the cluster.
<b>cluster keepalive loss-count &lt;int&gt;</b> <b>no cluster keepalive loss-count</b>	Set the max number of lost keep-alive messages that can be tolerated in the clusters.

#### 5. Remote cluster network management

Command	Explanation
Admin Mode	
<b>rcommand member &lt;member-id&gt;</b>	In the commander switch, this command is used to configure and manage member switches.
<b>rcommand commander</b>	In the member switch, this command is used to configure the commander switch.
<b>cluster reset member [id &lt;member-id&gt;   mac-address &lt;mac-addr&gt;]</b>	In the commander switch, this command is used to reset the member switch.
<b>cluster update member &lt;member-id&gt; &lt;src-url&gt; &lt;dst-filename&gt;[ascii   binary]</b>	In the commander switch, this command is used to remotely upgrade the member switch. It can only upgrade nos.img file.

---

## 6. Manage cluster network with web

Command	Explanation
Global Mode	
<b>ip http server</b>	Enable http function in commander switch and member switch. Notice: must insure the http function be enabled in member switch when commander switch visiting member switch by web. The commander switch visit member switch via beat member node in member cluster topology.

## 7. Manage cluster network with snmp

Command	Explanation
Global Mode	
<b>snmp-server enable</b>	Enable snmp server function in commander switch and member switch. Notice: must insure the snmp server function be enabled in member switch when commander switch visiting member switch by snmp. The commander switch visit member switch via configure character string <commander-community>@sw<member id>.

## 6.3 Examples of Cluster Administration

### Scenario:

The four switches SW1-SW4, amongst the SW1 is the command switch and other switches are member switch. The SW2 and SW4 is directly connected with the command switch, SW3 connects to the command switch through SW2.

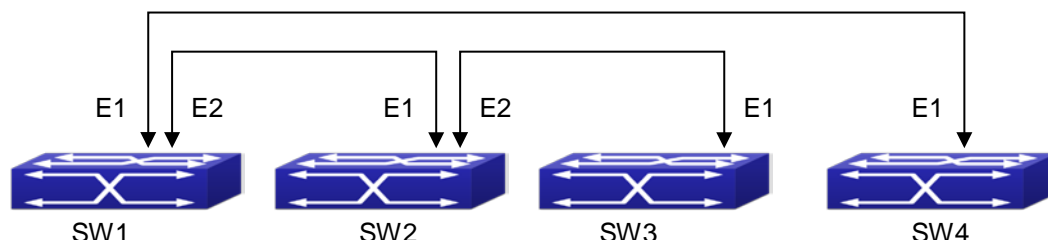

Figure 6-1 Examples of Cluster

### Configuration Procedure

#### 1. Configure the command switch

Configuration of SW1:

```
Switch(config)#cluster run
Switch(config)#cluster ip-pool 10.2.3.4
Switch(config)#cluster commander 5526
Switch(config)#cluster auto-add
```

#### 2. Configure the member switch

Configuration of SW2-SW4

```
Switch(config)#cluster run
```

## 6.4 Cluster Administration Troubleshooting

When encountering problems in applying the cluster admin, please check the following possible causes:

- If the command switch is correctly configured and the auto adding function (cluster auto-add) is enabled. If the ports connected the command switch and member switch belongs to the cluster vlan.
- After cluster commander is enabled in VLAN1 of the command switch, please don't enable a routing protocol (RIP, OSPF, BGP) in this VLAN in order to prevent the routing protocol from broadcasting the private cluster addresses in this VLAN to other switches and cause routing loops.
- Whether the connection between the command switch and the member switch is correct. We can use the debug cluster packets to check if the command and the member switches can receive and process related cluster admin packets correctly.

---

# Chapter 7 Port Configuration

## 7.1 Introduction to Port

SGS-6341 Series switches contain Cable ports and Combo ports. The Combo ports can be configured to as either 1000TX ports or SFP Gigabit fiber ports.

If the user needs to configure some network ports, he/she can use the interface ethernet <interface-list> command to enter the appropriate Ethernet port configuration mode, where <interface-list> stands for one or more ports. If <interface-list> contains multiple ports, special characters such as ';' or '-' can be used to separate ports, ';' is used for discrete port numbers and '-' is used for consecutive port numbers. Suppose an operation should be performed on ports 2, 3, 4, 5, the command would look like: interface ethernet 1/2-5. Port speed, duplex mode and traffic control can be configured under Ethernet Port Mode causing the performance of the corresponding network ports to change accordingly.

## 7.2 Network Port Configuration Task List

1. Enter the network port configuration mode
2. Configure the properties for the network ports
  - (1) Configure combo mode for combo ports
  - (2) Enable/Disable ports
  - (3) Configure port names
  - (4) Configure port cable types
  - (5) Configure port speed and duplex mode
  - (6) Configure bandwidth control
  - (7) Configure traffic control
  - (8) Enable/Disable port loopback function
  - (9) Configure broadcast storm control function for the switch
  - (10) Configure scan port mode
  - (11) Configure rate-violation control of the port
  - (12) Configure interval of port-rate-statistics
3. Virtual cable test

### 1. Enter the Ethernet port configuration mode

Command	Explanation
Global Mode	
<b>interface ethernet &lt;interface-list&gt;</b>	Enters the network port configuration mode.

## 2. Configure the properties for the Ethernet ports

Command	Explanation
Port Mode	
<b>combo-forced-mode {copper-forced   copper-preferred-auto   sfp-forced   sfp-preferred-auto }</b>	Sets the combo port mode (combo ports only).
<b>shutdown</b> <b>no shutdown</b>	Enables/Disables specified ports.
<b>name &lt;string&gt;</b> <b>no name</b>	Names or cancels the name of specified ports.
<b>mdi {auto   across   normal}</b> <b>no mdi</b>	Sets the cable type for the specified port; this command is not supported by combo port and fiber port of switch.
<b>speed-duplex {auto [10 [100 [1000]] [auto   full   half ]]}   force10-half   force10-full   force100-half   force100-full   force100-fx [module-type {auto-detected   no-phy-integrated   phy-integrated}]   {{force1g-half   force1g-full} [nonegotiate [master   slave]]}  force10g-full}</b> <b>no speed-duplex</b>	Sets port speed and duplex mode of 100/1000BASE-TX or 100BASE-FX ports. The no format of this command restores the default setting, i.e., negotiates speed and duplex mode automatically.
<b>negotiation {on off}</b>	Enables/Disables the auto-negotiation function of 1000BASE-FX ports.
<b>bandwidth control &lt;bandwidth&gt; [both   receive   transmit]</b> <b>no bandwidth control</b>	Sets or cancels the bandwidth used for incoming/outgoing traffic for specified ports.
<b>flow control</b> <b>no flow control</b>	Enables/Disables traffic control function for specified ports.
<b>loopback</b> <b>no loopback</b>	Enables/Disables loopback test function for specified ports.
<b>rate-suppression {dlf   broadcast   multicast} &lt;packets&gt;</b>	Enables the storm control function for broadcasts, multicasts and unicasts with unknown destinations (short for broadcast), and sets the allowed broadcast packet number; the no format of this command disables the broadcast storm control function.
<b>port-scan-mode {interrupt   poll}</b> <b>no port-scan-mode</b>	Configure port-scan-mode as interrupt or poll mode, the no command restores the default port-scan-mode.

<b>rate-violation &lt;200-2000000&gt;</b> <b>[recovery &lt;0-86400&gt;]</b> <b>no rate-violation</b>	Set the max packet reception rate of a port. If the rate of the received packet violates the packet reception rate, shut down this port and configure the recovery time, the default is 300s. The no command will disable the rate-violation function of a port.
Global Mode	
<b>port-rate-statistics interval [&lt;interval -value&gt;]</b>	Configure the interval of port-rate-statistics.

### 3. Virtual cable test

Command	Explanation
Port Configuration Mode	
<b>virtual-cable-test</b>	Test virtual cables of the port.

## 7.3 Port Configuration Example

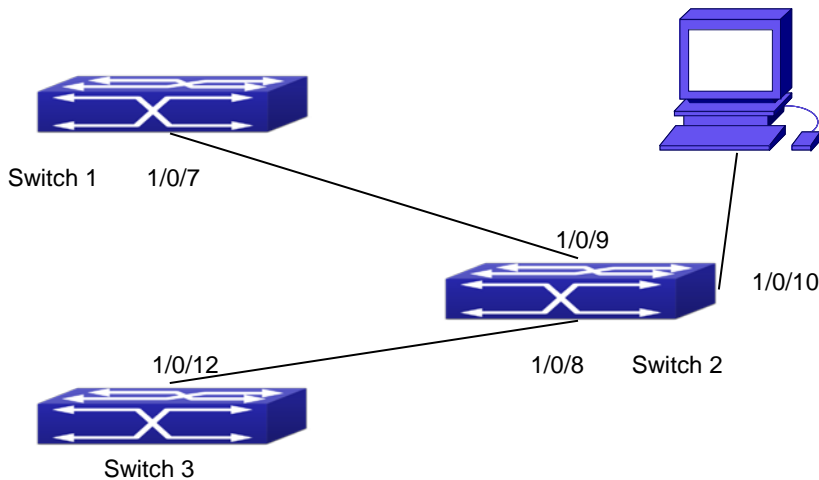

**Figure 7-1** Port Configuration Example

No VLAN has been configured in the switches, default VLAN1 is used.

Switch	Port	Property
Switch1	1/0/7	Ingress bandwidth limit: 50 M
Switch2	1/0/8	Mirror source port
	1/0/9	100Mbps full, mirror source port
	1/0/10	1000Mbps full, mirror destination port
Switch3	1/0/12	100Mbps full

---

The configurations are listed below:

**Switch1:**

```
Switch1(config)#interface ethernet 1/0/7
Switch1(Config-If-Ethernet1/0/7)#bandwidth control 50 both
```

**Switch2:**

```
Switch2(config)#interface ethernet 1/0/9
Switch2(Config-If-Ethernet1/0/9)#speed-duplex force100-full
Switch2(Config-If-Ethernet1/0/9)#exit
Switch2(config)#interface ethernet 1/0/10
Switch2(Config-If-Ethernet1/0/10)#speed-duplex force1g-full
Switch2(Config-If-Ethernet1/0/10)#exit
Switch2(config)#monitor session 1 source interface ethernet1/0/8;1/0/9
Switch2(config)#monitor session 1 destination interface ethernet 1/0/10
```

**Switch3:**

```
Switch3(config)#interface ethernet 1/0/12
Switch3(Config-If-Ethernet1/0/12)#speed-duplex force100-full
Switch3(Config-If-Ethernet1/0/12)#exit
```

## 7.4 Port Troubleshooting

Here are some situations that frequently occurs in port configuration and the advised solutions:

- Two connected fiber interfaces won't link up if one interface is set to auto-negotiation but the other to forced speed/duplex. This is determined by IEEE 802.3.
- The following combinations are not recommended: enabling traffic control as well as setting multicast limiting for the same port; setting broadcast, multicast and unknown destination unicast control as well as port bandwidth limiting for the same port. If such combinations are set, the port throughput may fall below the expected performance.
- For Combo port, it supports copper-forced mode and sfp-forced mode (default mode), here, copper port will not be up.



# Chapter 8 Port Isolation Function Configuration

## 8.1 Introduction to Port Isolation Function

Port isolation is an independent port-based function working in an inter-port way, which isolates flows of different ports from each other. With the help of port isolation, users can isolate ports within a VLAN to save VLAN resources and enhance network security. After this function is configured, the ports in a port isolation group will be isolated from each other, while ports belonging to different isolation groups or no such group can forward data to one another normally. No more than 16 port isolation groups can a switch have.

## 8.2 Task Sequence of Port Isolation

1. Create an isolate port group
2. Add Ethernet ports into the group
3. Specify the flow to be isolated
4. Display the configuration of port isolation

### 1. Create an isolate port group

Command	Explanation
Global Mode	
<b>isolate-port group &lt;WORD&gt;</b> <b>no isolate-port group &lt;WORD&gt;</b>	Set a port isolation group; the no operation of this command will delete the port isolation group.

### 2. Add Ethernet ports into the group

Command	Explanation
Global Mode	
<b>isolate-port group &lt;WORD&gt; switchport interface [ethernet   port-channel] &lt;IFNAME&gt;</b> <b>no isolate-port group &lt;WORD&gt; switchport interface [ethernet   port-channel] &lt;IFNAME&gt;</b>	Add one port or a group of ports into a port isolation group to isolate, which will become isolated from the other ports in the group; the no operation of this command will remove one port or a group of ports out of a port isolation group.

### 3. Specify the flow to be isolated

Command	Explanation
Global Mode	
<b>isolate-port apply [&lt;I2 I3 all&gt;]</b>	Apply the port isolation configuration to isolate layer-2 flows, layer-3 flows or all flows.

### 4. Display the configuration of port isolation

Command	Explanation
Admin Mode and global Mode	
<b>show isolate-port group [ &lt;WORD&gt; ]</b>	Display the configuration of port isolation, including all configured port isolation groups and Ethernet ports in each group.

## 8.3 Port Isolation Function Typical Examples

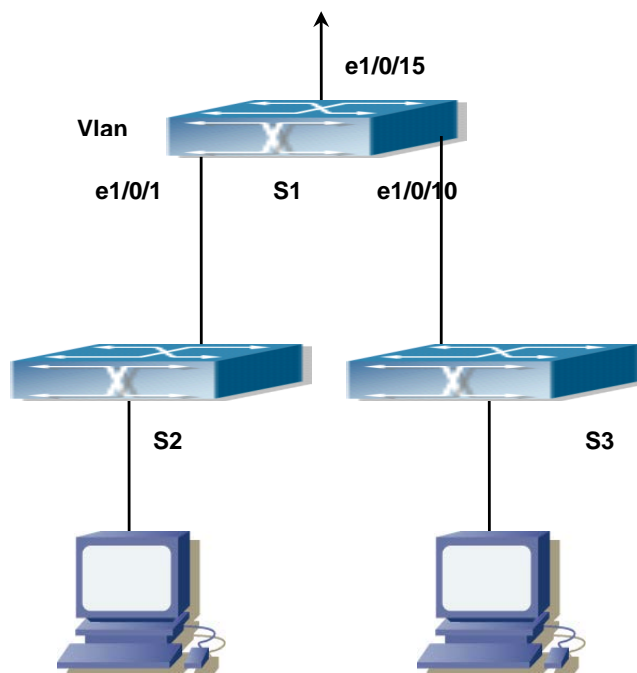

**Figure 8-1** A typical example of port isolation function

The topology and configuration of switches are showed in the figure above, with e1/0/1, e1/0/10 and e1/0/15 all belonging to VLAN 100. The requirement is that, after port isolation is enabled on switch S1, e1/0/1 and e1/0/10 on switch S1 can not communicate with each other, while both of them can communicate with the uplink port e1/0/15. That is, the communication between any pair of downlink ports is disabled while that between any downlink port and a specified uplink port is normal. The uplink port can communicate with any

port normally.

The configuration of S1:

```
Switch(config)#isolate-port group test
```

```
Switch(config)#isolate-port group test switchport interface ethernet 1/0/1;1/0/10
```

# Chapter 9 Port Loopback Detection Function Configuration

## 9.1 Introduction to Port Loopback Detection Function

With the development of switches, more and more users begin to access the network through Ethernet switches. In enterprise network, users access the network through layer-2 switches, which means urgent demands for both internet and the internal layer 2 Interworking. When layer 2 Interworking is required, the messages will be forwarded through MAC addressing the accuracy of which is the key to a correct Interworking between users. In layer 2 switching, the messages are forwarded through MAC addressing. Layer 2 devices learn MAC addresses via learning source MAC address, that is, when the port receives a message from an unknown source MAC address, it will add this MAC to the receive port, so that the following messages with a destination of this MAC can be forwarded directly, which also means learn the MAC address once and for all to forward messages.

When a new source MAC is already learnt by the layer 2 device, only with a different source port, the original source port will be modified to the new one, which means to correspond the original MAC address with the new port. As a result, if there is any loopback existing in the link, all MAC addresses within the whole layer 2 network will be corresponded with the port where the loopback appears (usually the MAC address will be frequently shifted from one port to another ), causing the layer 2 network collapsed. That is why it is a necessity to check port loopbacks in the network. When a loopback is detected, the detecting device should send alarms to the network management system, ensuring the network manager is able to discover, locate and solve the problem in the network and protect users from a long-lasting disconnected network.

Since detecting loopbacks can make dynamic judgment of the existence of loopbacks in the link and tell whether it has gone, the devices supporting port control (such as port isolation and port MAC address learning control) can maintain that automatically, which will not only reduce the burden of network managers but also response time, minimizing the effect caused loopbacks to the network.

## 9.2 Port Loopback Detection Function Configuration Task List

- 1 · Configure the time interval of loopback detection
- 2 · Enable the function of port loopback detection
- 3 · Configure the control method of port loopback detection
- 4 · Display and debug the relevant information of port loopback detection
- 5 · Configure the loopback-detection control mode (automatic recovery enabled or not)

### 1 · Configure the time interval of loopback detection

Command	Explanation
Global Mode	
<b>loopback-detection interval-time</b> <b>&lt;loopback&gt; &lt;no-loopback&gt;</b> <b>no loopback-detection interval-time</b>	Configure the time interval of loopback detection.

### 2 · Enable the function of port loopback detection

Command	Explanation
Port Mode	
<b>loopback-detection specified-vlan</b> <b>&lt;vlan-list&gt;</b> <b>no loopback-detection specified-vlan</b> <b>&lt;vlan-list&gt;</b>	Enable and disable the function of port loopback detection.

### 3 · Configure the control method of port loopback detection

Command	Explanation
Port Mode	
<b>loopback-detection control {shutdown</b> <b>[block] learning}</b> <b>no loopback-detection control</b>	Enable and disable the function of port loopback detection control.

### 4 · Display and debug the relevant information of port loopback detection

Command	Explanation
Admin Mode	
<b>debug loopback-detection</b> <b>no debug loopback-detection</b>	Enable the debug information of the function module of port loopback detection. The no operation of this command will disable the debug information.
<b>show loopback-detection [interface</b> <b>&lt;interface-list&gt;]</b>	Display the state and result of the loopback detection of all ports, if no parameter is provided; otherwise, display the state and result of the corresponding ports.

## 5. Configure the loopback-detection control mode (automatic recovery enabled or not)

Command	Explanation
Global Mode	
<b>loopback-detection control-recovery timeout &lt;0-3600&gt;</b>	Configure the loopback-detection control mode (automatic recovery enabled or not) or recovery time.

## 9.3 Port Loopback Detection Function Example

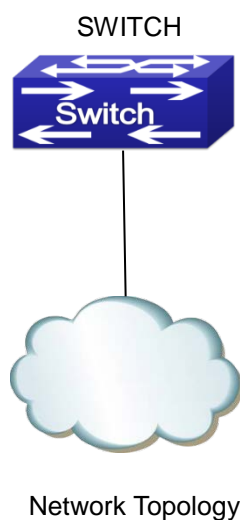

**Figure 9-1** A typical example of port loopback detection

As shown in the above configuration, the switch will detect the existence of loopbacks in the network topology. After enabling the function of loopback detection on the port connecting the switch with the outside network, the switch will notify the connected network about the existence of a loopback, and control the port on the switch to guarantee the normal operation of the whole network.

The configuration task sequence of SWITCH:

```
Switch(config)#loopback-detection interval-time 35 15
Switch(config)#interface ethernet 1/0/1
Switch(Config-If-Ethernet1/0/1)#loopback-detection special-vlan 1-3
Switch(Config-If-Ethernet1/0/1)#loopback-detection control block
```

If adopting the control method of block, MSTP should be globally enabled. And the corresponding relation between the spanning tree instance and the VLAN should be configured.

```
Switch(config)#spanning-tree
Switch(config)#spanning-tree mst configuration
Switch(Config-Mstp-Region)#instance 1 vlan 1
Switch(Config-Mstp-Region)#instance 2 vlan 2
Switch(Config-Mstp-Region)#
```

## 9.4 Port Loopback Detection Troubleshooting

The function of port loopback detection is disabled by default and should only be enabled if required.

---

# Chapter 10 ULDP Function Configuration

## 10.1 Introduction to ULDP Function

Unidirectional link is a common error state of link in networks, especially in fiber links. Unidirectional link means that only one part of the link can receive messages from the other port, while the latter one can not receive messages from the former one. Since the physical layer of the link is connected and works normal, via the checking mechanism of the physical layer, communication problems between the devices can not be found. As shown in Graph, the problem in fiber connection can not be found through mechanisms in physical layer like automatic negotiation.

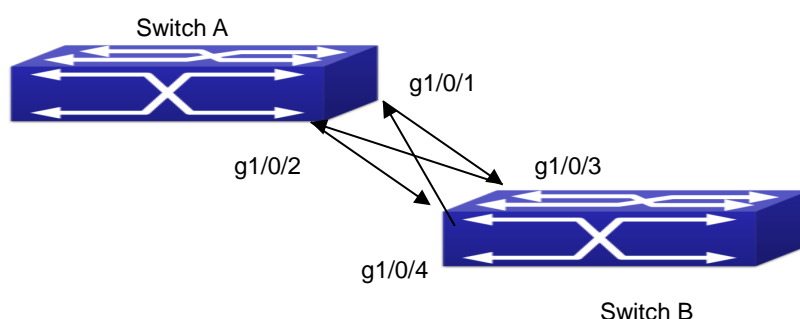

**Figure 10-1** Fiber Cross Connection

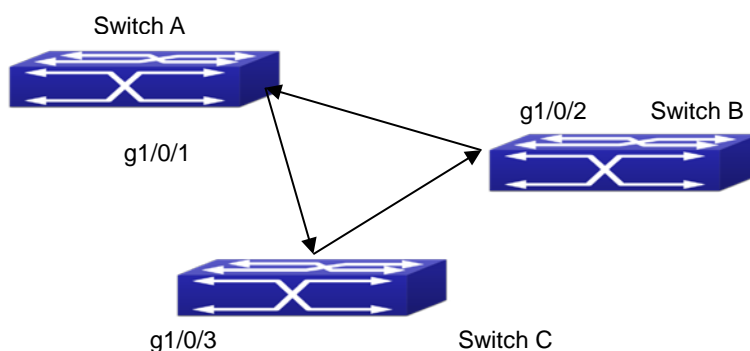

**Figure 10-2** One End of Each Fiber Not Connected

This kind of problem often appears in the following situations: GBIC (Giga Bitrate Interface Converter) or interfaces have problems, software problems, hardware becomes unavailable or operates abnormally. Unidirectional link will cause a series of problems, such as spinning tree topological loop, broadcast black hole.



---

ULDP (Unidirectional Link Detection Protocol) can help avoid disasters that could happen in the situations mentioned above. In a switch connected via fibers or copper Ethernet line (like ultra five-kind twisted pair), ULDP can monitor the link state of physical links. Whenever a unidirectional link is discovered, it will send warnings to users and can disable the port automatically or manually according to users' configuration.

The ULDP of switches recognizes remote devices and check the correctness of link connections via interacting ULDP messages. When ULDP is enabled on a port, protocol state machine will be started, which means different types of messages will be sent at different states of the state machine to check the connection state of the link by exchanging information with remote devices. ULDP can dynamically study the interval at which the remote device sends notification messages and adjust the local TTL (time to live) according to that interval. Besides, ULDP provides the reset mechanism, when the port is disabled by ULDP, it can check again through reset mechanism. The time intervals of notification messages and reset in ULDP can be configured by users, so that ULDP can respond faster to connection errors in different network environments.

The premise of ULDP working normally is that link works in duplex mode, which means ULDP is enabled on both ends of the link, using the same method of authentication and password.

## 10.2 ULDP Configuration Task Sequence

1. Enable ULDP function globally
2. Enable ULDP function on a port
3. Configure aggressive mode globally
4. Configure aggressive mode on a port
5. Configure the method to shut down unidirectional link
6. Configure the interval of Hello messages
7. Configure the interval of Recovery
8. Reset the port shut down by ULDP
9. Display and debug the relative information of ULDP

### 1. Enable ULDP function globally

Command	Explanation
Global configuration mode	
<b>uldp enable</b> <b>uldp disable</b>	Globally enable or disable ULDP function.

### 2. Enable ULDP function on a port

Command	Explanation
Port configuration mode	
<b>uldp enable</b> <b>uldp disable</b>	Enable or disable ULDP function on a port.

---

### 3. Configure aggressive mode globally

Command	Explanation
Global configuration mode	
<b>uldp aggressive-mode</b> <b>no uldp aggressive-mode</b>	Set the global working mode.

### 4. Configure aggressive mode on a port

Command	Explanation
Port configuration mode	
<b>uldp aggressive-mode</b> <b>no uldp aggressive-mode</b>	Set the working mode of the port.

### 5. Configure the method to shut down unidirectional link

Command	Explanation
Global configuration mode	
<b>uldp manual-shutdown</b> <b>no uldp manual-shutdown</b>	Configure the method to shut down unidirectional link.

### 6. Configure the interval of Hello messages

Command	Explanation
Global configuration mode	
<b>uldp hello-interval &lt;integer&gt;</b> <b>no uldp hello-interval</b>	Configure the interval of Hello messages, ranging from 5 to 100 seconds. The value is 10 seconds by default.

### 7. Configure the interval of Recovery

Command	Explanation
Global configuration mode	
<b>uldp recovery-time &lt;integer&gt;</b> <b>no uldp recovery-time &lt;integer&gt;</b>	Configure the interval of Recovery reset, ranging from 30 to 86400 seconds. The value is 0 second by default.

### 8. Reset the port shut down by ULDP

Command	Explanation
Global configuration mode or port configuration mode	

<b>uldp reset</b>	Reset all ports in global configuration mode; Rest the specified port in                      port configuration mode.
-------------------	---

### 9. Display and debug the relative information of ULDP

Command	Explanation
Admin mode	
<b>show uldp [interface ethernet IFNAME]</b>	Display ULDP information. No parameter means to display global ULDP information. The parameter specifying a port will display global information and the neighbor information of the port.
<b>debug uldp fsm interface ethernet &lt;IFname&gt;</b> <b>no debug uldp fsm interface ethernet &lt;IFname&gt;</b>	Enable or disable the debug switch of the state machine transition information on the specified port.
<b>debug uldp error</b> <b>no debug uldp error</b>	Enable or disable the debug switch of error information.
<b>debug uldp event</b> <b>no debug uldp event</b>	Enable or disable the debug switch of event information.
<b>debug uldp packet {receive send}</b> <b>no debug uldp packet {receive send}</b>	Enable or disable the type of messages can be received and sent on all ports.
<b>debug uldp {hello probe echo  unidir all}[receive send] interface ethernet &lt;IFname&gt;</b> <b>no debug uldp {hello probe echo  unidir all}[receive send] interface ethernet &lt;IFname&gt;</b>	Enable or disable the content detail of a particular type of messages can be received and sent on the specified port.

## 10.3 ULDP Function Typical Examples

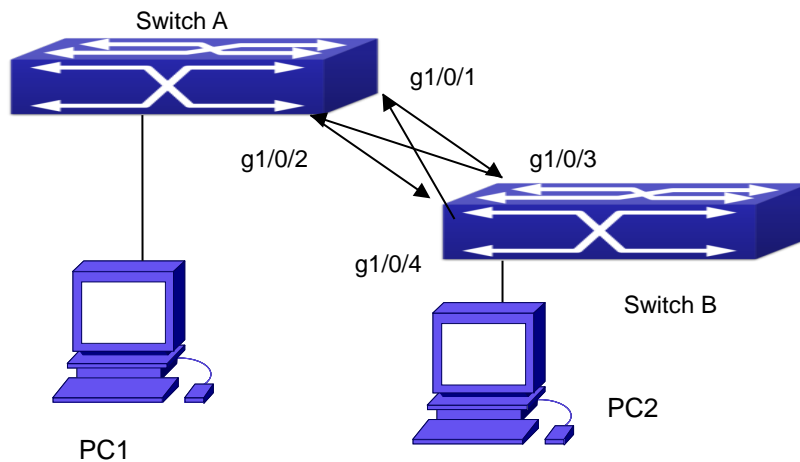

**Figure 10-3** Fiber Cross Connection

In the network topology in Graph, port g1/0/1 and port g1/0/2 of SWITCH A as well as port g1/0/3 and port g1/0/4 of SWITCH B are all fiber ports. And the connection is cross connection. The physical layer is connected and works normally, but the data link layer is abnormal. ULDP can discover and disable this kind of error state of link. The final result is that port g1/0/1, g1/0/2 of SWITCH A and port g1/0/3, g1/0/4 of SWITCH B are all shut down by ULDP. Only when the connection is correct, can the ports work normally (won't be shut down).

Switch A configuration sequence:

```
SwitchA(config)#uldp enable
SwitchA(config)#interface ethernet 1/0/1
SwitchA (Config-If-Ethernet1/0/1)#uldp enable
SwitchA (Config-If-Ethernet1/0/1)#exit
SwitchA(config)#interface ethernet1/0/2
SwitchA(Config-If-Ethernet1/0/2)#uldp enable
```

Switch B configuration sequence:

```
SwitchB(config)#uldp enable
SwitchB(config)#interface ethernet1/0/3
SwitchB(Config-If-Ethernet1/0/3)#uldp enable
SwitchB(Config-If-Ethernet1/0/3)#exit
SwitchB(config)#interface ethernet1/0/4
SwitchB(Config-If-Ethernet1/0/4)#uldp enable
```

As a result, port g1/0/1, g1/0/2 of SWITCH A are all shut down by ULDP, and there is notification information on the CRT terminal of PC1.

```
%Oct 29 11:09:50 2007 A unidirectional link is detected! Port Ethernet1/0/1 need to be shut down!  
%Oct 29 11:09:50 2007 Unidirectional port Ethernet1/0/1 shut down!  
%Oct 29 11:09:50 2007 A unidirectional link is detected! Port Ethernet1/0/2 need to be shut down!  
%Oct 29 11:09:50 2007 Unidirectional port Ethernet1/0/2 shut down!
```

Port g1/0/3, and port g1/0/4 of SWITCH B are all shut down by ULDP, and there is notification information on the CRT terminal of PC2.

```
%Oct 29 11:09:50 2007 A unidirectional link is detected! Port Ethernet1/0/3 need to be shut down!  
%Oct 29 11:09:50 2007 Unidirectional port Ethernet1/0/3 shut down!  
%Oct 29 11:09:50 2007 A unidirectional link is detected! Port Ethernet1/0/4 need to be shut down!  
%Oct 29 11:09:50 2007 Unidirectional port Ethernet1/0/4 shut down!
```

## 10.4 ULDP Troubleshooting

Configuration Notice:

- In order to ensure that ULDP can discover that the one of fiber ports has not connected or the ports are incorrectly cross connected, the ports have to work in duplex mode and have the same rate.
- If the automatic negotiation mechanism of the fiber ports with one port misconnected decides the working mode and rate of the ports, ULDP won't take effect no matter enabled or not. In such situation, the port is considered as "Down".
- In order to make sure that neighbors can be correctly created and unidirectional links can be correctly discovered, it is required that both end of the link should enable ULDP, using the same authentication method and password. At present, no password is needed on both ends.
- The hello interval of sending hello messages can be changed (it is 10 seconds by default and ranges from 5 to 100 seconds) so that ULDP can respond faster to connection errors of links in different network environments. But this interval should be less than 1/3 of the STP convergence time. If the interval is too long, a STP loop will be generated before ULDP discovers and shuts down the unidirectional connection port. If the interval is too short, the network burden on the port will be increased, which means a reduced bandwidth.
- ULDP does not handle any LACP event. It treats every link of TRUNK group (like Port-channel, TRUNK ports) as independent, and handles each of them respectively.
- ULDP does not compact with similar protocols of other vendors, which means users can not use ULDP on one end and use other similar protocols on the other end.
- ULDP function is disabled by default. After globally enabling ULDP function, the debug switch can be enabled simultaneously to check the debug information. There are several DEBUG commands provided to print debug information, such as information of events, state machine, errors and messages. Different types of message information can also be printed according to different parameters.
- The Recovery timer is disabled by default and will only be enabled when the users have configured recovery time (30-86400 seconds).
- Reset command and reset mechanism can only reset the ports automatically shut down by ULDP. The

---

ports shut down manually by users or by other modules won't be reset by ULDP.

---

# Chapter 11 LLDP Function Operation Configuration

## 11.1 Introduction to LLDP Function

**Link Layer Discovery Protocol (LLDP)** is a new protocol defined in 802.1ab. It enables neighbor devices to send notices of their own state to other devices, and enables all ports of every device to store information about them. If necessary, the ports can also send update information to the neighbor devices directly connected to them, and those neighbor devices will store the information in standard SNMP MIBs. The network management system can check the layer-two connection state from MIB. LLDP won't configure or control network elements or flows, but only report the configuration of layer-two. Another content of 802.1ab is to utilizing the information provided by LLDP to find the conflicts in layer-two. IEEE now uses the existing physical topology, interfaces and Entity MIBs of IETF.

To simplify, LLDP is a neighbor discovery protocol. It defines a standard method for Ethernet devices, such as switches, routers and WLAN access points, to enable them to notify their existence to other nodes in the network and store the discovery information of all neighbor devices. For example, the detail information of the device configuration and discovery can both use this protocol to advertise.

In specific, LLDP defines a general advertisement information set, a transportation advertisement protocol and a method to store the received advertisement information. The device to advertise its own information can put multiple pieces of advertisement information in one LAN data packet to transport. The type of transportation is the **type length value (TLV)** field. All devices supporting LLDP have to support device ID and port ID advertisement, but it is assumed that, most devices should also support system name, system description and system performance advertisement. System name and system description advertisement can also provide useful information for collecting network flow data. System description advertisement can include data such as the full name of the advertising device, hardware type of system, the version information of software operation system and so on.

802.1AB Link Layer Discovery Protocol will make searching the problems in an enterprise network an easier process and can strengthen the ability of network management tools to discover and maintain accurate network topology structure.

Many kinds of network management software use "Automated Discovery" function to trace the change and condition of topology, but most of them can reach layer-three and classify the devices into all IP subnets at best. This kind of data are very primitive, only referring to basic events like the adding and removing of relative devices instead of details about where and how these devices operate with the network.

Layer 2 discovery covers information like which devices have which ports, which switches connect to other devices and so on, it can also display the routs between clients, switches, routers, application servers and network servers. Such details will be very meaningful for schedule and investigate the source of network failure.

LLDP will be a very useful management tool, providing accurate information about network mirroring, flow data and searching network problems.

---

## 11.2 LLDP Function Configuration Task Sequence

1. Globally enable LLDP function
2. Configure the port-based LLDP function switch
3. Configure the operating state of port LLDP
4. Configure the intervals of LLDP updating messages
5. Configure the aging time multiplier of LLDP messages
6. Configure the sending delay of updating messages
7. Configure the intervals of sending Trap messages
8. Configure to enable the Trap function of the port
9. Configure the optional information-sending attribute of the port
10. Configure the size of space to store Remote Table of the port
11. Configure the type of operation when the Remote Table of the port is full
12. Display and debug the relative information of LLDP

### 1. Globally enable LLDP function

Command	Explanation
Global Mode	
<b>lldp enable</b> <b>lldp disable</b>	Globally enable or disable LLDP function.

### 2. Configure the port-base LLDP function switch

Command	Explanation
Port Mode	
<b>lldp enable</b> <b>lldp disable</b>	Configure the port-base LLDP function switch.

### 3. Configure the operating state of port LLDP

Command	Explanation
Port Mode	
<b>lldp mode (send receive both disable)</b>	Configure the operating state of port LLDP.

### 4. Configure the intervals of LLDP updating messages

Command	Explanation
Global Mode	
<b>lldp tx-interval &lt;integer&gt;</b> <b>no lldp tx-interval</b>	Configure the intervals of LLDP updating messages as the specified value or default value.



---

## 5. Configure the aging time multiplier of LLDP messages

Command	Explanation
Global Mode	
<b>lldp msgTxHold &lt;value&gt;</b> <b>no lldp msgTxHold</b>	Configure the aging time multiplier of LLDP messages as the specified value or default value.

## 6. Configure the sending delay of updating messages

Command	Explanation
Global Mode	
<b>lldp transmit delay &lt;seconds&gt;</b> <b>no lldp transmit delay</b>	Configure the sending delay of updating messages as the specified value or default value.

## 7. Configure the intervals of sending Trap messages

Command	Explanation
Global Mode	
<b>lldp notification interval &lt;seconds&gt;</b> <b>no lldp notification interval</b>	Configure the intervals of sending Trap messages as the specified value or default value.

## 8. Configure to enable the Trap function of the port

Command	Explanation
Port Configuration Mode	
<b>lldp trap &lt;enable/disable&gt;</b>	Enable or disable the Trap function of the port.

## 9. Configure the optional information-sending attribute of the port

Command	Explanation
Port Configuration Mode	
<b>lldp transmit optional tlv [portDesc]</b> <b>[sysName] [sysDesc] [sysCap]</b> <b>no lldp transmit optional tlv</b>	Configure the optional information-sending attribute of the port as the option value of default values.

**10. Configure the size of space to store Remote Table of the port**

Command	Explanation
Port Configuration Mode	
<b>lldp neighbors max-num &lt; value &gt;</b> <b>no lldp neighbors max-num</b>	Configure the size of space to store Remote Table of the port as the specified value or default value.

**11. Configure the type of operation when the Remote Table of the port is full**

Command	Explanation
Port Configuration Mode	
<b>lldp tooManyNeighbors {discard delete}</b>	Configure the type of operation when the Remote Table of the port is full.

**12. Display and debug the relative information of LLDP**

Command	Explanation
Admin, Global Mode	
<b>show lldp</b>	Display the current LLDP configuration information.
<b>show lldp interface ethernet &lt;IFNAME&gt;</b>	Display the LLDP configuration information of the current port.
<b>show lldp traffic</b>	Display the information of all kinds of counters.
<b>show lldp neighbors interface ethernet &lt; IFNAME &gt;</b>	Display the information of LLDP neighbors of the current port.
<b>show debugging lldp</b>	Display all ports with LLDP debug enabled.
Admin Mode	
<b>debug lldp</b> <b>no debug lldp</b>	Enable or disable the DEBUG switch.
<b>debug lldp packets interface ethernet &lt;IFNAME&gt;</b> <b>no debug lldp packets interface ethernet &lt;IFNAME&gt;</b>	Enable or disable the DEBUG packet-receiving and sending function in port or global mode.
Port configuration mode	
<b>clear lldp remote-table</b>	Clear Remote-table of the port.

## 11.3 LLDP Function Typical Example

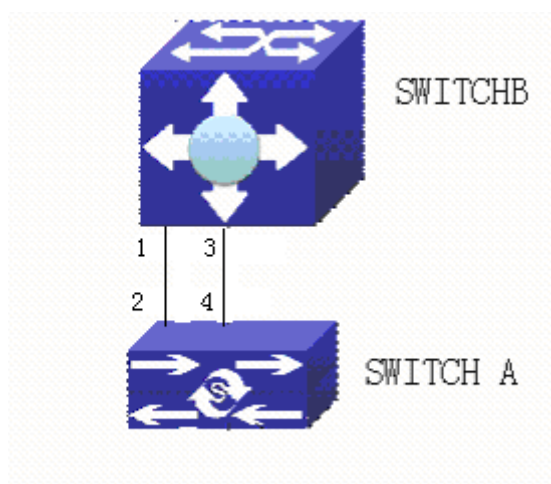

Figure 11-1 LLDP Function Typical Configuration Example

In the network topology graph above, the port 1,3 of SWITCH B are connected to port 2,4 of SWITCH A. Port 1 of SWITCH B is configured to message-receiving-only mode, Option TLV of port 4 of SWITCH A is configured as portDes and SysCap.

SWITCH A configuration task sequence:

```
SwitchA(config)# lldp enable
SwitchA(config)#interface ethernet 1/0/4
SwitchA(Config-If-Ethernet1/0/4)# lldp transmit optional tlv portDesc sysCap
SwitchA(Config-If-Ethernet1/0/4)#exit
```

SWITCH B configuration task sequence:

```
SwitchB(config)#lldp enable
SwitchB(config)#interface ethernet1/0/1
SwitchB(Config-If-Ethernet1/0/1)# lldp mode receive
SwitchB(Config-If-Ethernet1/0/1)#exit
```

## 11.4 LLDP Function Troubleshooting

- LLDP function is disabled by default. After enabling the global switch of LLDP, users can enable the debug switch “**debug lldp**” simultaneously to check debug information.
- Using “show” function of LLDP function can display the configuration information in global or port configuration mode.

---

# Chapter 12 Port Channel Configuration

## 12.1 Introduction to Port Channel

To understand Port Channel, Port Group should be introduced first. Port Group is a group of physical ports in the configuration level; only physical ports in the Port Group can take part in link aggregation and become a member port of a Port Channel. Logically, Port Group is not a port but a port sequence. Under certain conditions, physical ports in a Port Group perform port aggregation to form a Port Channel that has all the properties of a logical port, therefore it becomes an independent logical port. Port aggregation is a process of logical abstraction to abstract a set of ports (port sequence) with the same properties to a logical port. Port Channel is a collection of physical ports and used logically as one physical port. Port Channel can be used as a normal port by the user, and can not only add network's bandwidth, but also provide link backup. Port aggregation is usually used when the switch is connected to routers, PCs or other switches.

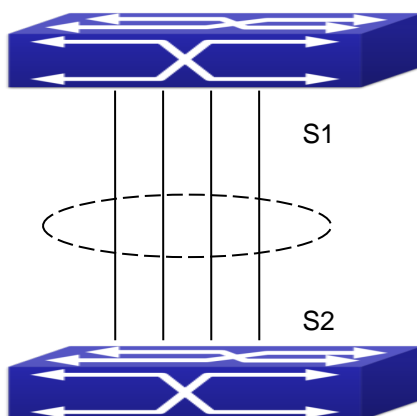

**Figure 12-1** Port aggregation

As shown in the above, S1 is aggregated to a Port Channel, the bandwidth of this Port Channel is the total of all the four ports. If traffic from S1 needs to be transferred to S2 through the Port Channel, traffic allocation calculation will be performed based on the source MAC address and the lowest bit of target MAC address. The calculation result will decide which port to convey the traffic. If a port in Port Channel fails, the other ports will undertake traffic of that port through a traffic allocation algorithm. This algorithm is carried out by the hardware.

Switch offers two methods for configuring port aggregation: manual Port Channel creation and LACP (Link Aggregation Control Protocol) dynamic Port Channel creation. Port aggregation can only be performed on ports in full-duplex mode.

---

For Port Channel to work properly, member ports of the Port Channel must have the same properties as follows:

- All ports are in full-duplex mode.
- All Ports are of the same speed.
- All ports are Access ports and belong to the same VLAN or are all TRUNK ports, or are all Hybrid ports.
- If the ports are all TRUNK ports or Hybrid ports , then their “Allowed VLAN” and “Native VLAN” property should also be the same.

If Port Channel is configured manually or dynamically on switch, the system will automatically set the port with the smallest number to be Master Port of the Port Channel. If the spanning tree function is enabled in the switch, the spanning tree protocol will regard Port Channel as a logical port and send BPDU frames via the master port.

Port aggregation is closely related with switch hardware. Switch allow physical port aggregation of any two switches, maximum 128 groups and 8 ports in each port group are supported.

Once ports are aggregated, they can be used as a normal port. Switch have a built-in aggregation interface configuration mode, the user can perform related configuration in this mode just like in the VLAN and physical interface configuration mode.

## 12.2 Brief Introduction to LACP

**LACP (Link Aggregation Control Protocol)** is a kind of protocol based on IEEE802.3ad standard to implement the link dynamic aggregation. LACP protocol uses LACPDU (Link Aggregation Control Protocol Data Unit) to exchange the information with the other end.

After LACP protocol of the port is enabled, this port will send LACPDU to the other end to notify the system priority, the MAC address of the system, the priority of the port, the port ID and the operation Key. After the other end receives the information, the information is compared with the saving information of other ports to select the port which can be aggregated, accordingly, both sides can reach an agreement about the ports join or exit the dynamic aggregation group.

The operation Key is created by LACP protocol according to the combination of configuration (speed, duplex, basic configuration, management Key) of the ports to be aggregated.

After the dynamic aggregation port enables LACP protocol, the management Key is 0 by default. After the static aggregation port enables LACP, the management Key of the port is the same with the ID of the aggregation group.

For the dynamic aggregation group, the members of the same group have the same operation Key, for the static aggregation group, the ports of Active have the same operation Key.

The port aggregation is that multi-ports are aggregated to form an aggregation group, so as to implement the out/in load balance in each member port of the aggregation group and provides the better reliability.

---

## 12.2.1 Static LACP Aggregation

Static LACP aggregation is enforced by users configuration, and do not enable LACP protocol. When configuring static LACP aggregation, use “on” mode to force the port to enter the aggregation group.

## 12.2.2 Dynamic LACP Aggregation

### 1. The summary of the dynamic LACP aggregation

Dynamic LACP aggregation is an aggregation created/deleted by the system automatically, it does not allow the user to add or delete the member ports of the dynamic LACP aggregation. The ports which have the same attribute of speed and duplex, are connected to the same device, have the same basic configuration, can be dynamically aggregated together. Even if only one port can create the dynamic aggregation, that is the single port aggregation. In the dynamic aggregation, LACP protocol of the port is at the enable state.

### 2. The port state of the dynamic aggregation group

In dynamic aggregation group, the ports have two states: selected or standby. Both selected ports and standby ports can receive and send LACP protocol, but standby ports can not forward the data packets. Because the limitation of the max port number in the aggregation group, if the current number of the member ports exceeds the limitation of the max port number, then the system of this end will negotiates with the other end to decide the port state according to the port ID. The negotiation steps are as follows:  
Compare ID of the devices (the priority of the system + the MAC address of the system). First, compare the priority of the systems, if they are same, then compare the MAC address of the systems. The end with a small device ID has the high priority.

Compare the ID of the ports (the priority of the port + the ID of the port). For each port in the side of the device which has the high device priority, first, compare the priority of the ports, if the priorities are same, then compare the ID of the ports. The port with a small port ID is selected, and the others become the standby ports.

In an aggregation group, the port which has the smallest port ID and is at the selected state will be the master port, the other ports at the selected state will be the member port.

## 12.3 Port Channel Configuration Task List

1. Create a port group in Global Mode
2. Add ports to the specified group from the Port Mode of respective ports
3. Enter port-channel configuration mode
4. Set load-balance method for Port-group
5. Set the system priority of LACP protocol
6. Set the port priority of the current port in LACP protocol
7. Set the timeout mode of the current port in LACP protocol

## 1. Creating a port group

Command	Explanation
Global Mode	
<b>port-group &lt;port-group-number&gt;</b> <b>no port-group &lt;port-group-number&gt;</b>	Create or delete a port group.

## 2. Add physical ports to the port group

Command	Explanation
Port Mode	
<b>port-group &lt;port-group-number&gt; mode</b> <b>{active   passive   on}</b> <b>no port-group</b>	Add the ports to the port group and set their mode.

## 3. Enter port-channel configuration mode.

Command	Explanation
Global Mode	
<b>interface port-channel</b> <b>&lt;port-channel-number&gt;</b>	Enter port-channel configuration mode.

## 4. Set load-balance method for Port-group

Command	Explanation
Aggregation port configuration mode	
<b>load-balance {dst-src-mac   dst-src-ip  </b> <b>dst-src-mac-ip}</b>	Set load-balance for switch, it takes effect on port-group and ECMP function at the same time.

## 5. Set the system priority of LACP protocol

Command	Explanation
Global mode	
<b>lacp system-priority &lt;system-priority&gt;</b> <b>no lacp system-priority</b>	Set the system priority of LACP protocol, the no command restores the default value.

## 6. Set the port priority of the current port in LACP protocol

Command	Explanation
Port mode	
<b>lacp port-priority &lt;port-priority&gt;</b> <b>no lacp port-priority</b>	Set the port priority in LACP protocol. The no command restores the default value.

---

## 7. Set the timeout mode of the current port in LACP protocol

Command	Explanation
Port mode	
<code>lacp timeout {short   long}</code> <code>no lacp timeout</code>	Set the timeout mode in LACP protocol. The no command restores the default value.

## 12.4 Port Channel Examples

**Scenario 1:** Configuring Port Channel in LACP.

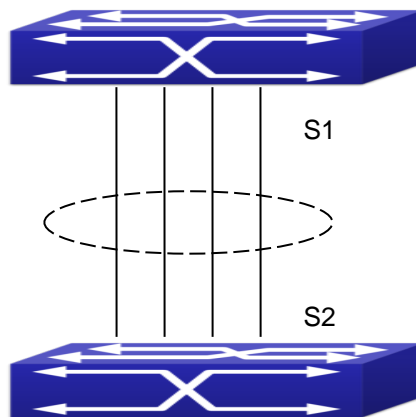

**Figure 12-2** Configuring Port Channel in LACP

The switches in the description below are all switch and as shown in the figure, ports 1, 2, 3, 4 of S1 are access ports and add them to group1 with active mode. Ports 6, 8, 9, 10 of S2 are access ports and add them to group2 with passive mode. All the ports should be connected with cables.



The configuration steps are listed below:

```
Switch1#config
Switch1(config)#interface ethernet 1/0/1-4
Switch1(Config-If-Port-Range)#port-group 1 mode active
Switch1(Config-If-Port-Range)#exit
Switch1(config)#interface port-channel 1
Switch1(Config-If-Port-Channel1)#
```

```
Switch2#config
Switch2(config)#port-group 2
Switch2(config)#interface ethernet 1/0/6
Switch2(Config-If-Ethernet1/0/6)#port-group 2 mode passive
Switch2(Config-If-Ethernet1/0/6)#exit
Switch2(config)#interface ethernet 1/0/8-10
Switch2(Config-If-Port-Range)#port-group 2 mode passive
Switch2(Config-If-Port-Range)#exit
Switch2(config)#interface port-channel 2
Switch2(Config-If-Port-Channel2)#
```

#### Configuration result:

Shell prompts ports aggregated successfully after a while, now ports 1, 2, 3, 4 of S1 form an aggregated port named "Port-Channel1", ports 6, 8, 9, 10 of S2 form an aggregated port named "Port-Channel2"; can be configured in their respective aggregated port mode.

Scenario 2: Configuring Port Channel in ON mode.

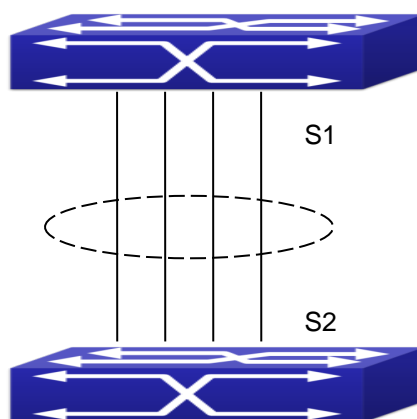

Figure 12-3 Configuring Port Channel in ON mode

---

As shown in the figure, ports 1, 2, 3, 4 of S1 are access ports and add them to group1 with “on” mode. Ports 6, 8, 9, 10 of S2 are access ports and add them to group2 with “on” mode.

**The configuration steps are listed below:**

```
Switch1#config
Switch1(config)#interface ethernet 1/0/1
Switch1(Config-If-Ethernet1/0/1)#port-group 1 mode on
Switch1(Config-If-Ethernet1/0/1)#exit
Switch1(config)#interface ethernet 1/0/2
Switch1(Config-If-Ethernet1/0/2)#port-group 1 mode on
Switch1(Config-If-Ethernet1/0/2)#exit
Switch1(config)#interface ethernet 1/0/3
Switch1(Config-If-Ethernet1/0/3)#port-group 1 mode on
Switch1(Config-If-Ethernet1/0/3)#exit
Switch1(config)#interface ethernet 1/0/4
Switch1(Config-If-Ethernet1/0/4)#port-group 1 mode on
Switch1(Config-If-Ethernet1/0/4)#exit
```

```
Switch2#config
Switch2(config)#port-group 2
Switch2(config)#interface ethernet 1/0/6
Switch2(Config-If-Ethernet1/0/6)#port-group 2 mode on
Switch2(Config-If-Ethernet1/0/6)#exit
Switch2(config)#interface ethernet 1/0/8-10
Switch2(Config-If-Port-Range)#port-group 2 mode on
Switch2(Config-If-Port-Range)#exit
```

**Configuration result:**

Add ports 1, 2, 3, 4 of S1 to port-group1 in order, and we can see a group in “on” mode is completely joined forcedly, switch in other ends won’t exchange LACP PDU to complete aggregation. Aggregation finishes immediately when the command to add port 2 to port-group 1 is entered, port 1 and port 2 aggregate to be port-channel 1, when port 3 joins port-group 1, port-channel 1 of port 1 and 2 are ungrouped and re-aggregate with port 3 to form port-channel 1, when port 4 joins port-group 1, port-channel 1 of port 1, 2 and 3 are ungrouped and re-aggregate with port 4 to form port-channel 1. (It should be noted that whenever a new port joins in an aggregated port group, the group will be ungrouped first and re-aggregated to form a new group.) Now all four ports in both S1 and S2 are aggregated in “on” mode and become an aggregated port respectively.

---

## 12.5 Port Channel Troubleshooting

If problems occur when configuring port aggregation, please first check the following for causes.

- Ensure all ports in a port group have the same properties, i.e., whether they are in full-duplex mode, forced to the same speed, and have the same VLAN properties, etc. If inconsistency occurs, make corrections.
- Some commands cannot be used on a port in port-channel, such as arp, bandwidth, ip, ip-forward, etc.

---

# Chapter 13 Jumbo Configuration

## 13.1 Introduction to Jumbo

So far the Jumbo (Jumbo Frame) has not reach a determined standard in the industry (including the format and length of the frame). Normally frames sized within 1519-9000 should be considered jumbo frame. Networks with jumbo frames will increase the speed of the whole network by 2% to 5%. Technically the Jumbo is just a lengthened frame sent and received by the switch. However considering the length of Jumbo frames, they will not be sent to CPU. We discard the Jumbo frames sent to CPU in the packet receiving process.

## 13.2 Jumbo Configuration Task Sequence

### 1. Configure enable Jumbo function

Command	Explanation
Global Mode	
<b>jumbo enable [&lt;mtu-value&gt;]</b> <b>no jumbo enable</b>	Enable sending/receiving function of the Jumbo frames. The no command disables sending and receiving function of the Jumbo frames.

---

# Chapter 14 EFM OAM Configuration

## 14.1 Introduction to EFM OAM

Ethernet is designed for Local Area Network at the beginning, but link length and network scope is extended rapidly while Ethernet is also applied to Metropolitan Area Network and Wide Area Network along with development. Due to lack the effectively management mechanism, it affects Ethernet application to Metropolitan Area Network and Wide Area Network, implementing OAM on Ethernet becomes a necessary development trend.

There are four protocol standards about Ethernet OAM, they are 802.3ah (EFM OAM), 802.3ag (CFM), E-LMI and Y.1731. EFM OAM and CFM are set for IEEE organization. EFM OAM works in data link layer to validly discover and manage the data link status of rock-bottom. Using EFM OAM can effectively advance management and maintenance for Ethernet to ensure the stable network operation. CFM is used for monitoring the whole network connectivity and locating the fault in access aggregation network layer. Compare with CFM, Y.1731 standard set by ITU (International Telecommunications Union) is more powerful. E-LMI standard set by MEF is only applied to UNI. So above protocols can be used to different network topology and management, between them exist the complementary relation.

EFM OAM (Ethernet in the First Mile Operation, Administration and Maintenance) works in data link layer of OSI model to implement the relative functions through OAM sublayer, figure is shown below:

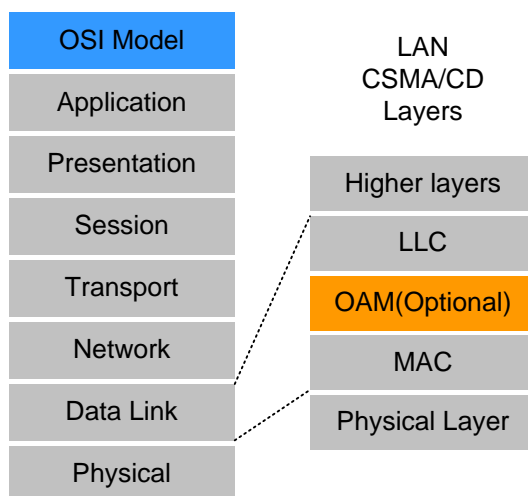

**Figure 14-1** OAM location in OSI model

OAM protocol data units (OAMPDU) use destination MAC address 01-80-c2-00-00-02 of protocol, the max transmission rate is 10Pkt/s.

EFM OAM is established on the basis of OAM connection, it provides a link operation management mechanism such as link monitoring, remote fault detection and remote loopback testing, the simple introduction for EFM OAM in the following:

---

## 1. Ethernet OAM connection establishment

Ethernet OAM entity discovers remote OAM entities and establishes sessions with them by exchanging Information OAMPDUs. EFM OAM can operate in two modes: active mode and passive mode. One session can only be established by the OAM entity working in the active mode and ones working in the passive mode need to wait until it receives the connection request. After an Ethernet OAM connection is established, the Ethernet OAM entities on both sides exchange Information OAMPDUs continuously to keep the valid Ethernet OAM connection. If an Ethernet OAM entity receives no Information OAMPDU for five seconds, the Ethernet OAM connection is disconnected.

## 2. Link Monitoring

Fault detection in an Ethernet is difficult, especially when the physical connection in the network is not disconnected but network performance is degrading gradually. Link monitoring is used to detect and discover link faults in various environments. EFM OAM implements link monitoring through the exchange of Event Notification OAMPDUs. When detecting a link error event, the local OAM entity sends an Event Notification OAMPDU to notify the remote OAM entity. At the same time it will log information and send SNMP Trap to the network management system. While OAM entity on the other side receives the notification, it will also log and report it. With the log information, network administrators can keep track of network status in time.

The link event monitored by EFM OAM means that the link happens the error event, including Errored symbol period event, Errored frame event, Errored frame period event, Errored frame seconds event.

Errored symbol period event: The errored symbol number can not be less than the low threshold. (Symbol: the min data transmission unit of physical medium. It is unique for coding system, the symbols may be different for different physical mediums, symbol rate means the changed time of electron status per second. )

Errored frame period event: Specifying N is frame period, the errored frame number within the period of receiving N frames can not be less than the low threshold. (Errored frame: Receiving the errored frame detected by CRC.)

Errored frame event: The number of detected error frames over M seconds can not be less than the low threshold.

Errored frame seconds event: The number of error frame seconds detected over M seconds can not be less than the low threshold. (Errored frame second: Receiving an errored frame at least in a second.)

## 3. Remote Fault Detection

In a network where traffic is interrupted due to device failures or unavailability, the flag field defined in Ethernet OAMPDUs allows an Ethernet OAM entity to send fault information to its peer. As Information OAMPDUs are exchanged continuously across established OAM connections, an Ethernet OAM entity can inform one of its OAM peers of link faults through Information OAMPDUs. Therefore, the network administrator can keep track of link status in time through the log information and troubleshoot in time.

There are three kinds of link faults for Information OAMPDU, they are Critical Event, Dying Gasp and Link Fault, and their definitions are different for each manufacturer, here the definitions are as below:

Critical Event: EFM OAM function of port is disabled.

Link Fault: The number of unidirectional operation or fault can not be less than the high threshold in local. Unidirectional Operation means unidirectional link can not work normally on full-duplex link without auto-negotiation. EFM OAM can detect the fault and inform the remote OAM peers through sending Information OAMPDU.

Dying Gasp: There is no definition present. Although device does not generate Dying Gasp OAMPDU, it still receives and processes such OAMPDU sent by its peer.

#### 4. Remote loopback testing

Remote loopback testing is available only after an Ethernet OAM connection is established. With remote loopback enabled, operating Ethernet OAM entity in active mode issues remote loopback requests and the peer responds to them. If the peer operates in loopback mode, it returns all packets except Ethernet OAMPDUs to the senders along the original paths. Performing remote loopback testing periodically helps to detect network faults in time. Furthermore, performing remote loopback testing by network segments helps to locate network faults. Note: The communication will not be processed normally in remote loopback mode.

Typical EFM OAM application topology is in the following, it is used for point-to-point link and emulational IEEE 802.3ah point-to-point link. Device enables EFM OAM through point-to-point connection to monitor the link fault in the First Mile with Ethernet access. For user, the connection between user to telecommunication is “the First Mile”, for service provider, it is “the Last Mile”.

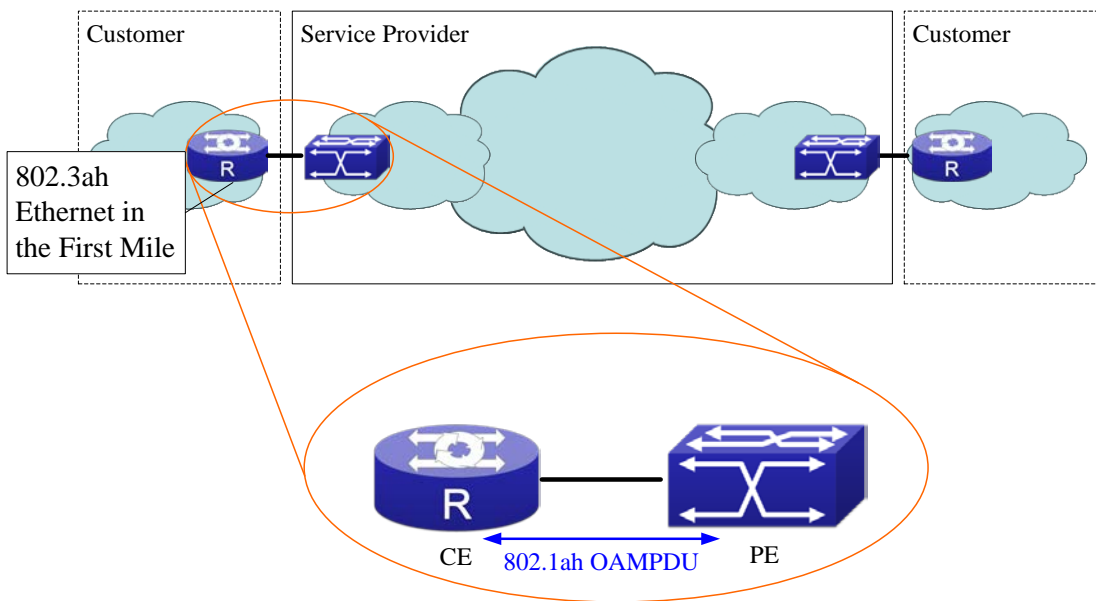

Figure 14-2 Typical OAM application topology

## 14.2 EFM OAM Configuration

EFM OAM configuration task list

1. Enable EFM OAM function of port
2. Configure link monitor
3. Configure remote failure
4. Enable EFM OAM loopback of port

Note: it needs to enable OAM first when configuring OAM parameters.

## 1. Enable EFM OAM function of port

Command	Explanation
Port mode	
<b>ethernet-oam mode {active   passive}</b>	Configure work mode of EFM OAM, default is active mode.
<b>ethernet-oam</b> <b>no ethernet-oam</b>	Enable EFM OAM of port, no command disables EFM OAM of port.
<b>ethernet-oam period &lt;seconds&gt;</b> <b>no ethernet-oam period</b>	Configure transmission period of OAMPDU (optional), no command restores the default value.
<b>ethernet-oam timeout &lt;seconds&gt;</b> <b>no ethernet-oam timeout</b>	Configure timeout of EFM OAM connection, no command restores the default value.

## 2. Configure link monitor

Command	Explanation
Port mode	
<b>ethernet-oam link-monitor</b> <b>no ethernet-oam link-monitor</b>	Enable link monitor of EFM OAM, no command disables link monitor.
<b>ethernet-oam errored-symbol-period</b> <b>{threshold low &lt;low-symbols&gt;   window &lt;seconds&gt;}</b> <b>no ethernet-oam errored-symbol-period</b> <b>{threshold low   window }</b>	Configure the low threshold and window period of errored symbol period event, no command restores the default value. (optional)
<b>ethernet-oam errored-frame-period</b> <b>{threshold low &lt;low-frames&gt;   window &lt;seconds&gt;}</b> <b>no ethernet-oam errored-frame-period</b> <b>{threshold low   window }</b>	Configure the low threshold and window period of errored frame period event, no command restores the default value.
<b>ethernet-oam errored-frame {threshold low &lt;low-frames&gt;   window &lt;seconds&gt;}</b> <b>no ethernet-oam errored-frame {threshold low   window }</b>	Configure the low threshold and window period of errored frame event, no command restores the default value. (optional)
<b>ethernet-oam errored-frame-seconds</b> <b>{threshold low &lt;low-frame-seconds&gt;   window &lt;seconds&gt;}</b> <b>no ethernet-oam errored-frame-seconds</b> <b>{threshold low   window }</b>	Configure the low threshold and window period of errored frame seconds event, no command restores the default value. (optional)



### 3. Configure remote failure

Command	Explanation
Port mode	
<b>ethernet-oam remote-failure</b> <b>no ethernet-oam remote-failure</b>	Enable remote failure detection of EFM OAM (failure means critical-event or link-fault event of the local), no command disables the function. (optional)
<b>ethernet-oam errored-symbol-period threshold high {high-symbols   none}</b> <b>no ethernet-oam errored-symbol-period threshold high</b>	Configure the high threshold of errored symbol period event, no command restores the default value. (optional)
<b>ethernet-oam errored-frame-period threshold high {high-frames   none}</b> <b>no ethernet-oam errored-frame-period threshold high</b>	Configure the high threshold of errored frame period event, no command restores the default value. (optional)
<b>ethernet-oam errored-frame threshold high {high-frames   none}</b> <b>no ethernet-oam errored-frame threshold high</b>	Configure the high threshold of errored frame event, no command restores the default value. (optional)
<b>ethernet-oam errored-frame-seconds threshold high {high-frame-seconds   none}</b> <b>no ethernet-oam errored-frame-seconds threshold high</b>	Configure the high threshold of errored frame seconds event, no command restores the default value. (optional)

### 4. Enable EFM OAM loopback of port

Command	Explanation
Port mode	
<b>ethernet-oam remote-loopback</b> <b>no ethernet-oam remote-loopback</b>	Enable remote EFM OAM entity to enter OAM loopback mode (its peer needs to configure OAM loopback supporting), no command cancels remote OAM loopback.
<b>ethernet-oam remote-loopback supported</b> <b>no ethernet-oam remote-loopback supported</b>	Enable remote loopback supporting of port, no command cancels remote loopback supporting of port.

## 14.3 EFM OAM Example

Example:

CE and PE devices with point-to-point link enable EFM OAM to monitor “the First Mile” link performance. It will report the log information to network management system when occurring fault event and use remote loopback function to detect the link in necessary instance

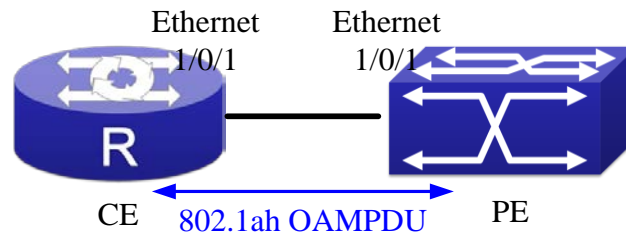

**Figure 14-3** Typical OAM application topology

Configuration procedure: (Omitting SNMP and Log configuration in the following)

Configuration on CE:

```
CE(config)#interface ethernet 1/0/1
CE (config-if-ethernet1/0/1)#ethernet-oam mode passive
CE (config-if-ethernet1/0/1)#ethernet-oam
CE (config-if-ethernet1/0/1)#ethernet-oam remote-loopback supported
Other parameters use the default configuration.
```

Configuration on PE:

```
PE(config)#interface ethernet 1/0/1
PE (config-if-ethernet1/0/1)#ethernet-oam
Other parameters use the default configuration.
```

Execute the following command when using remote loopback.

```
PE(config-if-ethernet1/0/1)#ethernet-oam remote-loopback
Execute the following command to make one of OAM peers exiting OAM loopback after complete
detection.
PE(config-if-ethernet1/0/1)# no ethernet-oam remote-loopback
Execute the following command without supporting remote loopback.
CE(config-if-ethernet1/0/1)#no ethernet-oam remote-loopback supported
```

---

## 14.4 EFM OAM Troubleshooting

When using EFM OAM, it occurs the problem, please check whether the problem is resulted by the following reasons:

- Check whether OAM entities of two peers of link in passive mode. If so, EFM OAM connection can not be established between two OAM entities.
- Ensuring SNMP configuration is correct, or else errored event can not be reported to network management system.
- Link does not normally communicate in OAM loopback mode, it should cancel remote loopback in time after detect the link performance.
- Ensuring the used board supports remote loopback function.
- Port should not configure STP, MRPP, ULPP, Flow Control, loopback detection functions after it enables OAM loopback function, because OAM remote loopback function and these functions are mutually exclusive.
- When enabling OAM, the negotiation of the port will be disabled automatically. So the negotiation in the peer of the link must be disabled, otherwise the link connection will unsuccessful. When disabling OAM, the negotiation of the port will be restored. Therefore, to ensure the link connection is normal, the negotiations must be accordant in two peers of the link.
- After enabling OAM, when the link negotiations in two peers are successful, the state is up. After the fiber in RX redirection of the peer is pulled out, TX of the peer and RX with OAM are normal, so the port with OAM will be at up state all along.

---

# Chapter 15 VLAN Configuration

## 15.1 VLAN Configuration

### 15.1.1 Introduction to VLAN

VLAN (Virtual Local Area Network) is a technology that divides the logical addresses of devices within the network to separate network segments basing on functions, applications or management requirements. By this way, virtual workgroups can be formed regardless of the physical location of the devices. IEEE announced IEEE 802.1Q protocol to direct the standardized VLAN implementation, and the VLAN function of switch is implemented following IEEE 802.1Q.

The key idea of VLAN technology is that a large LAN can be partitioned into many separate broadcast domains dynamically to meet the demands.

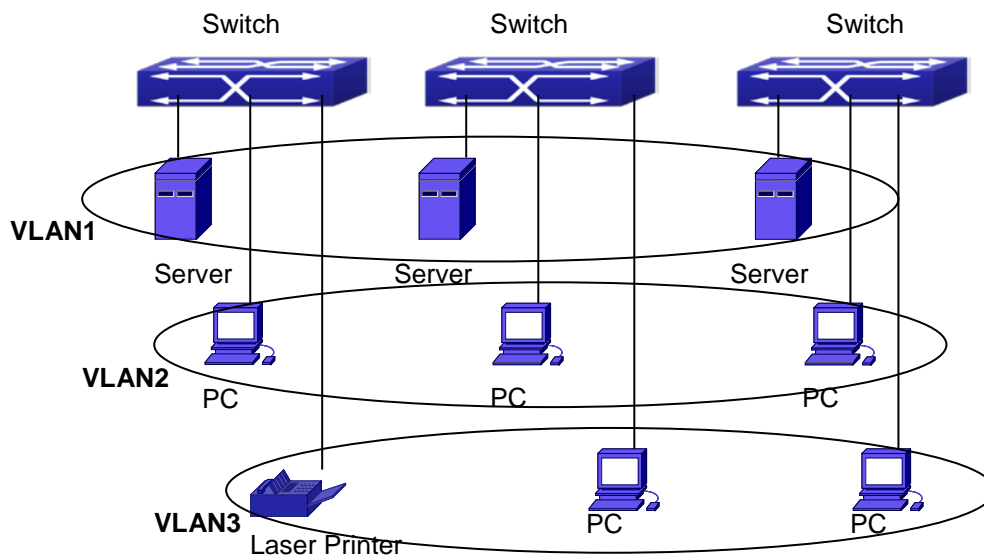

**Figure 15-1** A VLAN network defined logically

Each broadcast domain is a VLAN. VLANs have the same properties as the physical LANs, except VLAN is a logical partition rather than physical one. Therefore, the partition of VLANs can be performed regardless of physical locations, and the broadcast, multicast and unicast traffic within a VLAN is separated from the other VLANs.

With the aforementioned features, VLAN technology provides us with the following convenience:

- Improving network performance
- Saving network resources
- Simplifying network management
- Lowering network cost
- Enhancing network security

---

SGS-6341 Series Switch Ethernet Ports can work in three kinds of modes: Access, Hybrid and Trunk, each mode has a different processing method in forwarding the packets with tagged or untagged.

The ports of Access type only belong to one VLAN, usually they are used to connect the ports of the computer.

The ports of Trunk type allow multi-VLANs to pass, can receive and send the packets of multi-VLANs. Usually they are used to connect between the switches.

The ports of Hybrid type allow multi-VLANs to pass, can receive and send the packets of multi-VLANs. They can be used to connect between the switches, or to a computer of the user.

Hybrid ports and Trunk ports receive the data with the same process method, but send the data with different method: Hybrid ports can send the packets of multi-VLANs without the VLAN tag, while Trunk ports send the packets of multi-VLANs with the VLAN tag except the port native VLAN.

The switch implements VLAN and GVRP (GARP VLAN Registration Protocol) which are defined by 802.1Q. The chapter will explain the use and the configuration of VLAN and GVRP in detail.

## 15.1.2 VLAN Configuration Task List

1. Create or delete VLAN
2. Set or delete VLAN name
3. Assign Switch ports for VLAN
4. Set the switch port type
5. Set Trunk port
6. Set Access port
7. Set Hybrid port
8. Enable/Disable VLAN ingress rules on ports
9. Configure Private VLAN
10. Set Private VLAN association
11. Specify internal VLAN ID

### 1. Create or delete VLAN

Command	Explanation
Global Mode	
<b>vlan WORD</b> <b>no vlan WORD</b>	Create/delete VLAN or enter VLAN Mode

### 2. Set or delete VLAN name

Command	Explanation
Global Mode	
<b>name &lt;vlan-name&gt;</b> <b>no name</b>	Set or delete VLAN name.

---

### 3. Assigning Switch ports for VLAN

Command	Explanation
VLAN Mode	
<b>switchport interface &lt;interface-list&gt;</b> <b>no switchport interface &lt;interface-list&gt;</b>	Assign Switch ports to VLAN.

### 4. Set the Switch Port Type

Command	Explanation
Port Mode	
<b>switchport mode {trunk   access   hybrid}</b>	Set the current port as Trunk, Access Hybrid port.

### 5. Set Trunk port

Command	Explanation
Port Mode	
<b>switchport trunk allowed vlan {WORD   all   add WORD   except WORD remove WORD}</b> <b>no switchport trunk allowed vlan</b>	Set/delete VLAN allowed to be crossed by Trunk. The “no” command restores the default setting.
<b>switchport trunk native vlan &lt;vlan-id&gt;</b> <b>no switchport trunk native vlan</b>	Set/delete PVID for Trunk port.

### 6. Set Access port

Command	Explanation
Port Mode	
<b>switchport access vlan &lt;vlan-id&gt;</b> <b>no switchport access vlan</b>	Add the current port to the specified VLAN. The “no” command restores the default setting.

### 7. Set Hybrid port

Command	Explanation
Port Mode	
<b>switchport hybrid allowed vlan {WORD   all   add WORD   except WORD remove WORD} {tag untag}</b> <b>no switchport hybrid allowed vlan</b>	Set/delete the VLAN which is allowed by Hybrid port with tag or untag mode.
<b>switchport hybrid native vlan &lt;vlan-id&gt;</b> <b>no switchport hybrid native vlan</b>	Set/delete PVID of the port.

---

## 8. Disable/Enable VLAN Ingress Rules

Command	Explanation
Port Mode	
<b>vlan ingress enable</b> <b>no vlan ingress enable</b>	Enable/Disable VLAN ingress rules.

## 9. Configure Private VLAN

Command	Explanation
VLAN mode	
<b>private-vlan {primary   isolated   community}</b> <b>no private-vlan</b>	Configure current VLAN to Private VLAN. The no command deletes private VLAN.

## 10. Set Private VLAN association

Command	Explanation
VLAN mode	
<b>private-vlan association</b> <b>&lt;secondary-vlan-list&gt;</b> <b>no private-vlan association</b>	Set/delete Private VLAN association.

## 11. Specify internal VLAN ID

Command	Explanation
Global mode	
<b>vlan &lt;2-4094&gt; internal</b>	Specify internal VLAN ID.

### 15.1.3 Typical VLAN Application

Scenario:

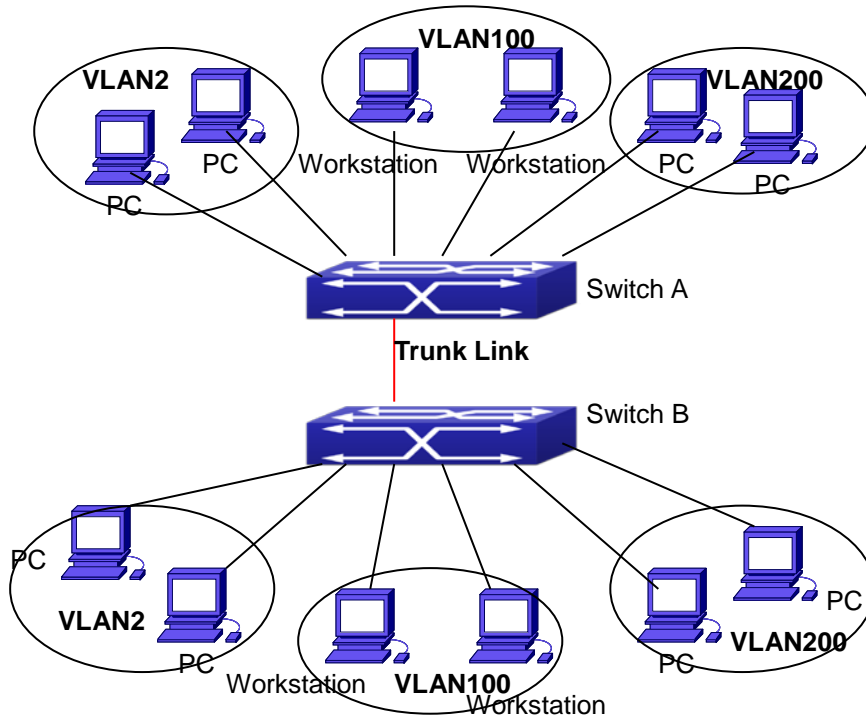

**Figure 15-2** Typical VLAN Application Topology

The existing LAN is required to be partitioned to 3 VLANs due to security and application requirements. The three VLANs are VLAN2, VLAN100 and VLAN200. Those three VLANs are cross two different location A and B. One switch is placed in each site, and cross-location requirement can be met if VLAN traffic can be transferred between the two switches.

Configuration Item	Configuration description
VLAN2	Site A and site B switch port 2 -4.
VLAN100	Site A and site B switch port 5 -7.
VLAN200	Site A and site B switch port 8 -10.
Trunk port	Site A and site B switch port 11.

Connect the Trunk ports of both switches for a Trunk link to convey the cross-switch VLAN traffic; connect all network devices to the other ports of corresponding VLANs.

In this example, port 1 and port 12 is spared and can be used for management port or for other purposes.

The configuration steps are listed below:



---

**Switch A:**

```
Switch(config)#vlan 2
Switch(Config-Vlan2)#switchport interface ethernet 1/0/2-4
Switch(Config-Vlan2)#exit
Switch(config)#vlan 100
Switch(Config-Vlan100)#switchport interface ethernet 1/0/5-7
Switch(Config-Vlan100)#exit
Switch(config)#vlan 200
Switch(Config-Vlan200)#switchport interface ethernet 1/0/8-10
Switch(Config-Vlan200)#exit
Switch(config)#interface ethernet 1/0/11
Switch(Config-If-Ethernet1/0/11)#switchport mode trunk
Switch(Config-If-Ethernet1/0/11)#exit
Switch(config)#
```

**Switch B:**

```
Switch(config)#vlan 2
Switch(Config-Vlan2)#switchport interface ethernet 1/0/2-4
Switch(Config-Vlan2)#exit
Switch(config)#vlan 100
Switch(Config-Vlan100)#switchport interface ethernet 1/0/5-7
Switch(Config-Vlan100)#exit
Switch(config)#vlan 200
Switch(Config-Vlan200)#switchport interface ethernet 1/0/8-10
Switch(Config-Vlan200)#exit
Switch(config)#interface ethernet 1/0/11
Switch(Config-If-Ethernet1/0/11)#switchport mode trunk
Switch(Config-If-Ethernet1/0/11)#exit
```

## 15.1.4 Typical Application of Hybrid Port

Scenario:

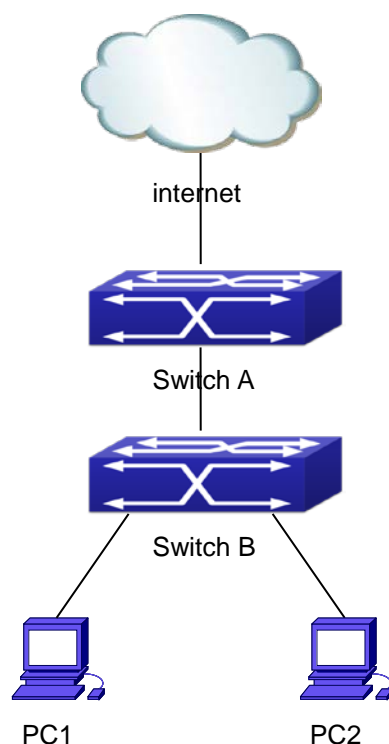

**Figure 15-3** Typical Application of Hybrid Port

PC1 connects to the interface Ethernet 1/0/7 of SwitchB, PC2 connects to the interface Ethernet 1/0/9 of SwitchB, Ethernet 1/0/10 of SwitchA connect to Ethernet 1/0/10 of SwitchB.

It is required that PC1 and PC2 can not mutually access due to reason of the security, but PC1 and PC2 can access other network resources through the gateway SwitchA. We can implement this status through Hybrid port.

Configuration items are as follows:

Port	Type	PVID	the VLANs are allowed to pass
Port 1/0/10 of Switch A	Access	10	Allow the packets of VLAN 10 to pass with untag method.
Port 1/0/10 of Switch B	Hybrid	10	Allow the packets of VLAN 7, 9, 10 to pass with untag method.
Port 1/0/7 of Switch B	Hybrid	7	Allow the packets of VLAN 7, 10 to pass with untag method.
Port 1/0/9 of Switch B	Hybrid	9	Allow the packets of VLAN 9, 10 to pass with untag method.

---

The configuration steps are listed below:

**Switch A:**

```
Switch (config)#vlan 10
Switch (Config-Vlan10)#switchport interface ethernet 1/0/10
```

**Switch B:**

```
Switch(config)#vlan 7;9;10
Switch(config)#interface ethernet 1/0/7
Switch(Config-If-Ethernet1/0/7)#switchport mode hybrid
Switch(Config-If-Ethernet1/0/7)#switchport hybrid native vlan 7
Switch(Config-If-Ethernet1/0/7)#switchport hybrid allowed vlan 7;10 untag
Switch(Config-If-Ethernet1/0/7)#exit
Switch(Config)#interface Ethernet 1/0/9
Switch(Config-If-Ethernet1/0/9)#switchport mode hybrid
Switch(Config-If-Ethernet1/0/9)#switchport hybrid native vlan 9
Switch(Config-If-Ethernet1/0/9)#switchport hybrid allowed vlan 9;10 untag
Switch(Config-If-Ethernet1/0/9)#exit
Switch(Config)#interface Ethernet 1/0/10
Switch(Config-If-Ethernet1/0/10)#switchport mode hybrid
Switch(Config-If-Ethernet1/0/10)#switchport hybrid native vlan 10
Switch(Config-If-Ethernet1/0/10)#switchport hybrid allowed vlan 7;9;10 untag
Switch(Config-If-Ethernet1/0/10)#exit
```

---

## 15.2 GVRP Configuration

### 15.2.1 Introduction to GVRP

GVRP, i.e. GARP VLAN Registration Protocol, is an application of GARP (Generic Attribute Registration Protocol). GARP is mainly used to establish an attribute transmission mechanism to transmit attributes, so as to ensure protocol entities registering and deregistering the attribute. According to different transmission attributes, GARP can be divided to many application protocols, such as GMRP and GVRP. Therefore, GVRP is a protocol which transmits VLAN attributes to the whole layer 2 network through GARP protocol.

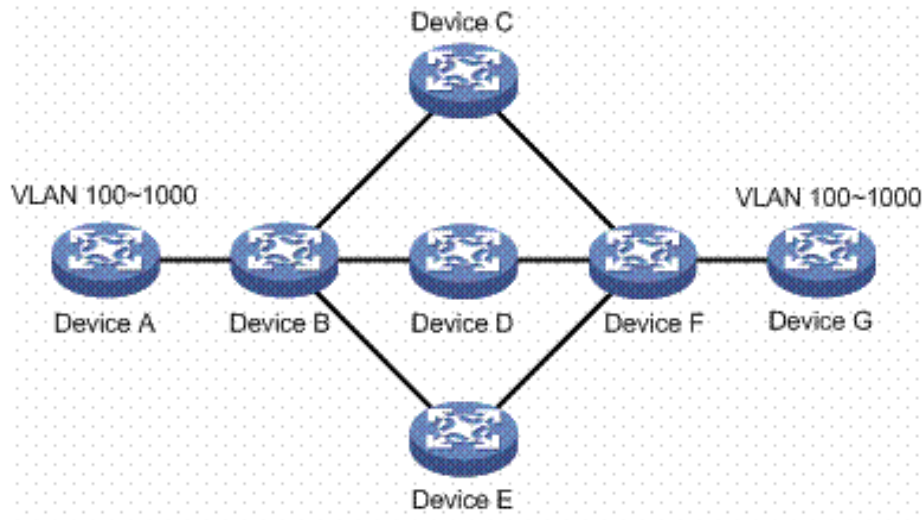

**Figure 15-4** a typical application scene

A and G switches are not directly connected in layer 2 network; BCDEF are intermediate switches connecting A and G. Switch A and G configure VLAN100-1000 manually while BCDEF switches do not. When GVRP is not enabled, A and G cannot communicate with each other, because intermediate switches without relevant VLANs. However, after GVRP is enabled on all switches, its VLAN attribute transmission mechanism enables the intermediate switches registering the VLANs dynamically, and the VLAN in VLAN100-1000 of A and G can communicate with each other. The VLANs dynamically registered by intermediate switches will be deregistered when deregistering VLAN100-1000 of A and G switches manually. So the same VLAN of two unadjacent switches can communicate mutually through GVRP protocol instead of configuring each intermediate switch manually for achieving the purpose of simplifying VLAN configuration.

---

## 15.2.2 GVRP Configuration Task List

GVRP configuration task list:

1. Configure GVRP timer
2. Configure port type
3. Enable GVRP function

### 1. Configure GARP timer

Command	Explanation
Global Mode	
<b>garp timer join &lt;200-500&gt;</b> <b>garp timer leave &lt;500-1200&gt;</b> <b>garp timer leaveall &lt;5000-60000&gt;</b> <b>no garp timer (join   leave   leaveAll)</b>	Configure leaveall, join and leave timer for GVRP.

### 2. Configure port type

Command	Explanation
Port mode	
<b>gvrp</b> <b>no gvrp</b>	Enable/ disable GVRP function of port.

### 3. Configure GVRP function

Command	Explanation
Global Mode	
<b>gvrp</b> <b>no gvrp</b>	Enable/disable the GVRP function for the switch.

## 15.2.3 Example of GVRP

GVRP application:

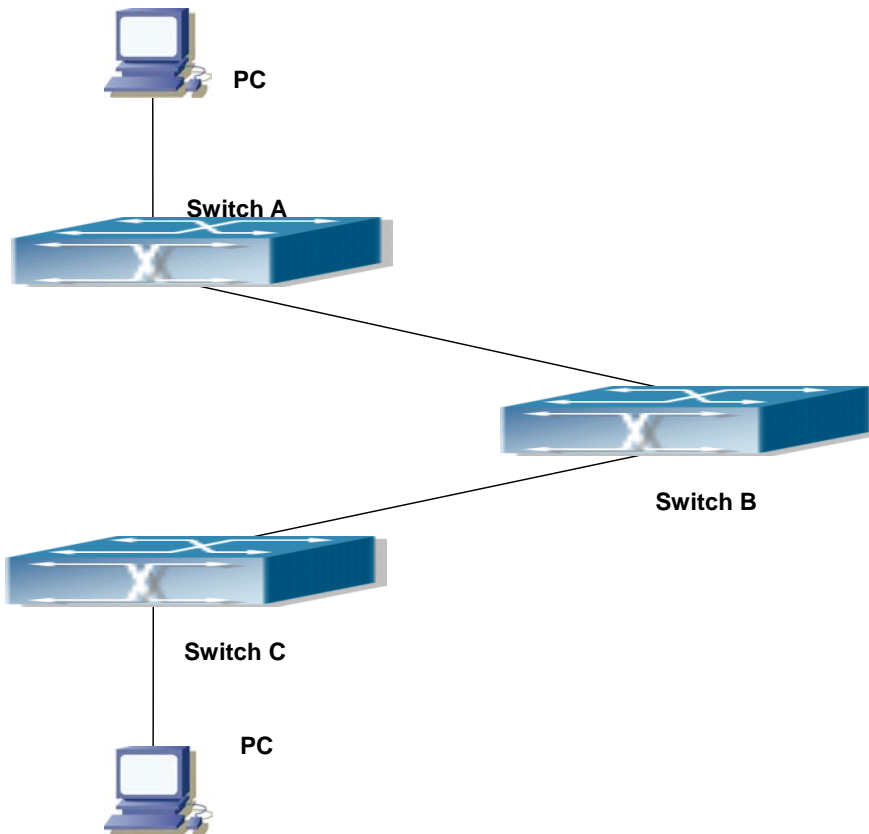

**Figure 15-5** Typical GVRP Application Topology

To enable dynamic VLAN information register and update among switches, GVRP protocol is to be configured in the switch. Configure GVRP in Switch A, B and C, enable Switch B to learn VLAN100 dynamically so that two workstations connected to VLAN100 in Switch A and C can communicate with each other through Switch B without static VLAN100 entries.

Configuration Item	Configuration description
VLAN100	Port 2 -6 of Switch A and C.
Trunk port	Port 11 of Switch A and C, Port 10, 11 of Switch B.
Global GVRP	Switch A, B, C.
Port GVRP	Port 11 of Switch A and C, Port 10, 11 of Switch B.

Connect the two workstation to the VLAN100 ports in switch A and B, connect port 11 of Switch A to port 10 of Switch B, and port 11 of Switch B to port 11 of Switch C.

---

The configuration steps are listed below:

**Switch A:**

```
Switch(config)# gvrp
Switch(config)#vlan 100
Switch(Config-Vlan100)#switchport interface ethernet 1/0/2-6
Switch(Config-Vlan100)#exit
Switch(config)#interface ethernet 1/0/11
Switch(Config-If-Ethernet1/0/11)#switchport mode trunk
Switch(Config-If-Ethernet1/0/11)# gvrp
Switch(Config-If-Ethernet1/0/11)#exit
```

**Switch B:**

```
Switch(config)#gvrp
Switch(config)#interface ethernet 1/0/10
Switch(Config-If-Ethernet1/0/10)#switchport mode trunk
Switch(Config-If-Ethernet1/0/10)# gvrp
Switch(Config-If-Ethernet1/0/10)#exit
Switch(config)#interface ethernet 1/0/11
Switch(Config-If-Ethernet1/0/11)#switchport mode trunk
Switch(Config-If-Ethernet1/0/11)# gvrp
Switch(Config-If-Ethernet1/0/11)#exit
```

**Switch C:**

```
Switch(config)# gvrp
Switch(config)#vlan 100
Switch(Config-Vlan100)#switchport interface ethernet 1/0/2-6
Switch(Config-Vlan100)#exit
Switch(config)#interface ethernet 1/0/11
Switch(Config-If-Ethernet1/0/11)#switchport mode trunk
Switch(Config-If-Ethernet1/0/11)# gvrp
Switch(Config-If-Ethernet1/0/11)#exit
```

## 15.2.4 GVRP Troubleshooting

The GARP counter setting for Trunk ports in both ends of Trunk link must be the same, otherwise GVRP will not work normally. It is recommended to avoid enabling GVRP and RSTP at the same time in switch. If GVRP needs to be enabled, RSTP function for the ports must be disabled first.

## 15.3 Dot1q-tunnel Configuration

### 15.3.1 Introduction to Dot1q-tunnel

Dot1q-tunnel is also called Q-in-Q (802.1Q-in-802.1Q), which is an expansion of 802.1Q. Its dominating idea is encapsulating the customer VLAN tag (CVLAN tag) to the service provider VLAN tag (SPVLAN tag). Carrying the two VLAN tags the packet is transmitted through the backbone network of the ISP internet, so to provide a simple layer-2 tunnel for the users. It is simple and easy to manage, applicable only by static configuration, and especially adaptive to small office network or small scale metropolitan area network using layer-3 switch as backbone equipment.

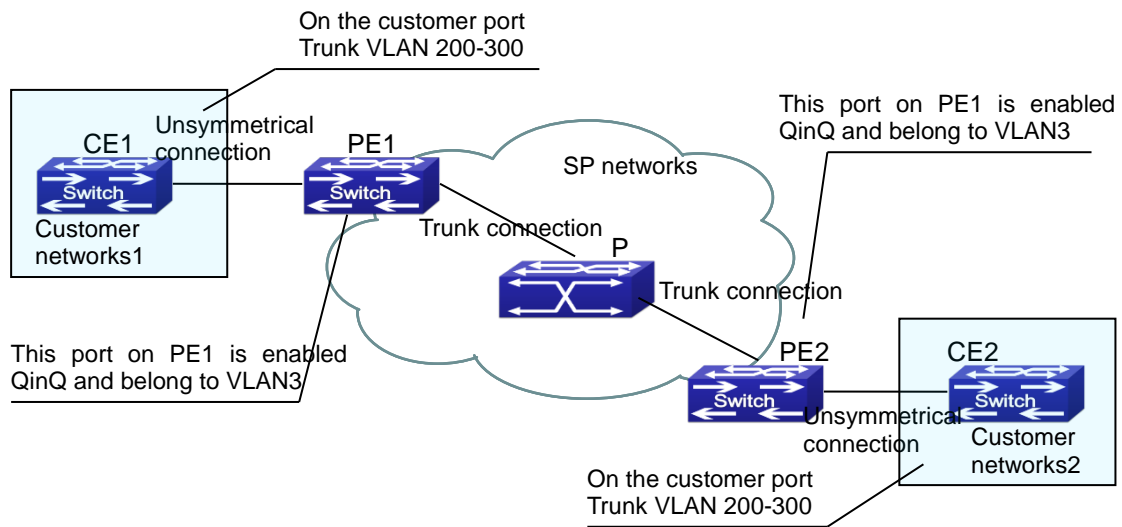

**Figure 15-6** Dot1q-tunnel based Internetworking mode

As shown in above, after being enabled on the user port, dot1q-tunnel assigns each user an SPVLAN identification (SPVID). Here the identification of user is 3. Same SPVID should be assigned for the same network user on different PEs. When packet reaches PE1 from CE1, it carries the VLAN tag 200-300 of the user internal network. Since the dot1q-tunnel function is enabled, the user port on PE1 will add on the packet another VLAN tag, of which the ID is the SPVID assigned to the user. Afterwards, the packet will only be transmitted in VLAN3 when traveling in the ISP internet network while carrying two VLAN tags (the inner tag is added when entering PE1, and the outer is SPVID), whereas the VLAN information of the user network is open to the provider network. When the packet reaches PE2 and before being forwarded to CE2 from the client port on PE2, the outer VLAN tag is removed, then the packet CE2 receives is absolutely identical to the one sent by CE1. For the user, the role the operator network plays between PE1 and PE2, is to provide a reliable layer-2 link.

The technology of Dot1q-tunnel provides the ISP internet the ability of supporting many client VLANs by only one VLAN of their selves. Both the ISP internet and the clients can configure their own VLAN independently.

It is obvious that, the dot1q-tunnel function has got following characteristics:

- Applicable through simple static configuration, no complex configuration or maintenance to be needed.
- Operators will only have to assign one SPVID for each user, which increases the number of concurrent supportable users; while the users has got the ultimate freedom in selecting and managing the VLAN IDs (select within 1~4096 at users' will).



- The user network is considerably independent. When the ISP internet is upgrading their network, the user networks do not have to change their original configuration.

Detailed description on the application and configuration of dot1q-tunnel will be provided in this section.

## 15.3.2 Dot1q-tunnel Configuration

Configuration Task Sequence of Dot1q-Tunnel:

1. Configure the dot1q-tunnel function on port
2. Configure the protocol type (TPID) on port

### 1. Configure the dot1q-tunnel function on the ports

Command	Explanation
Port mode	
<b>dot1q-tunnel enable</b> <b>no dot1q-tunnel enable</b>	Enter/exit the dot1q-tunnel mode on the ports.

### 2. Configure the type of protocol (TPID) on the ports

Command	Explanation
Port mode	
<b>dot1q-tunnel tpid</b> <b>{0x8100 0x9100 0x9200 &lt;1-65535&gt;}</b>	Configure the type of protocol on TRUNK port.

## 15.3.3 Typical Applications of the Dot1q-tunnel

### Scenario:

Edge switch PE1 and PE2 of the ISP internet forward the VLAN200~300 data between CE1 and CE2 of the client network with VLAN3. The port1 of PE1 is connected to CE1, port10 is connected to public network, the TPID of the connected equipment is 9100; port1 of PE2 is connected to CE2, port10 is connected to public network.

Configuration Item	Configuration Explanation
VLAN3	Port1 of PE1 and PE2.
dot1q-tunnel	Port1 of PE1 and PE2.
tpid	9100

---

Configuration procedure is as follows:

**PE1:**

```
Switch(config)#vlan 3
Switch(Config-Vlan3)#switchport interface ethernet 1/0/1
Switch(Config-Vlan3)#exit
Switch(Config)#interface ethernet 1/0/1
Switch(Config-Ethernet1/0/1)# dot1q-tunnel enable
Switch(Config-Ethernet1/0/1)# exit
Switch(Config)#interface ethernet 1/0/1
Switch(Config-Ethernet1/0/1)#switchport mode trunk
Switch(Config-Ethernet1/0/1)#dot1q-tunnel tpid 0x9100
Switch(Config-Ethernet1/0/1)#exit
Switch(Config)#
```

**PE2:**

```
Switch(config)#vlan 3
Switch(Config-Vlan3)#switchport interface ethernet 1/0/1
Switch(Config-Vlan3)#exit
Switch(Config)#interface ethernet 1/0/1
Switch(Config-Ethernet1/0/1)# dot1q-tunnel enable
Switch(Config-Ethernet1/0/1)# exit
Switch(Config)#interface ethernet 1/0/1
Switch(Config-Ethernet1/0/1)#switchport mode trunk
Switch(Config-Ethernet1/0/1)#dot1q-tunnel tpid 0x9100
Switch(Config-Ethernet1/0/1)#exit
Switch(Config)#
```

### 15.3.4 Dot1q-tunnel Troubleshooting

- Enabling dot1q-tunnel on Trunk port will make the tag of the data packet unpredictable which is not required in the application. So it is not recommended to enable dot1q-tunnel on Trunk port.
- Enabled with STP/MSTP is not supported.
- Enabled with PVLAN is not supported.

---

## 15.4 VLAN-translation Configuration

### 15.4.1 Introduction to VLAN-translation

VLAN translation, as one can tell from the name, which translates the original VLAN ID to new VLAN ID according to the user requirements so to exchange data across different VLANs. VLAN translation is classified to ingress translation and egress translation, this switch only supports switchover of ingress for VLAN ID.

Application and configuration of VLAN translation will be explained in detail in this section.

### 15.4.2 VLAN-translation Configuration

Configuration task sequence of VLAN-translation:

1. Configure the VLAN-translation function on the port
2. Configure the VLAN-translation relations on the port
3. Configure whether the packet is dropped when checking VLAN-translation is failing
4. Show the related configuration of vlan-translation

#### 1. Configure the VLAN-translation of the port

Command	Explanation
Port mode	
<b>vlan-translation enable</b> <b>no vlan-translation enable</b>	Enter/exit the port VLAN-translation mode.

#### 2. Configure the VLAN-translation relation of the port

Command	Explanation
Port mode	
<b>vlan-translation &lt;old-vlan-id&gt; to &lt;new-vlan-id&gt; {in out}</b> <b>no vlan-translation old-vlan-id {in out}</b>	Add/delete a VLAN-translation relation.

#### 3. Configure whether the packet is dropped when checking VLAN-translation is failing

Command	Explanation
Port mode	
<b>vlan-translation miss drop in</b> <b>no vlan-translation miss drop in</b>	Configure the VLAN-translation packet dropped on port if there is any failure.

#### 4. Show the related configuration of vlan-translation

Command	Explanation
Admin mode	
<b>show vlan-translation</b>	Show the related configuration of vlan-translation.

### 15.4.3 Typical application of VLAN-translation

#### Scenario:

Edge switch PE1 and PE2 of the ISP internet support the VLAN20 data task between CE1 and CE2 of the client network with VLAN3. The port1 of PE1 is connected to CE1, port10 is connected to public network; port1 of PE2 is connected to CE2, port10 is connected to public network.

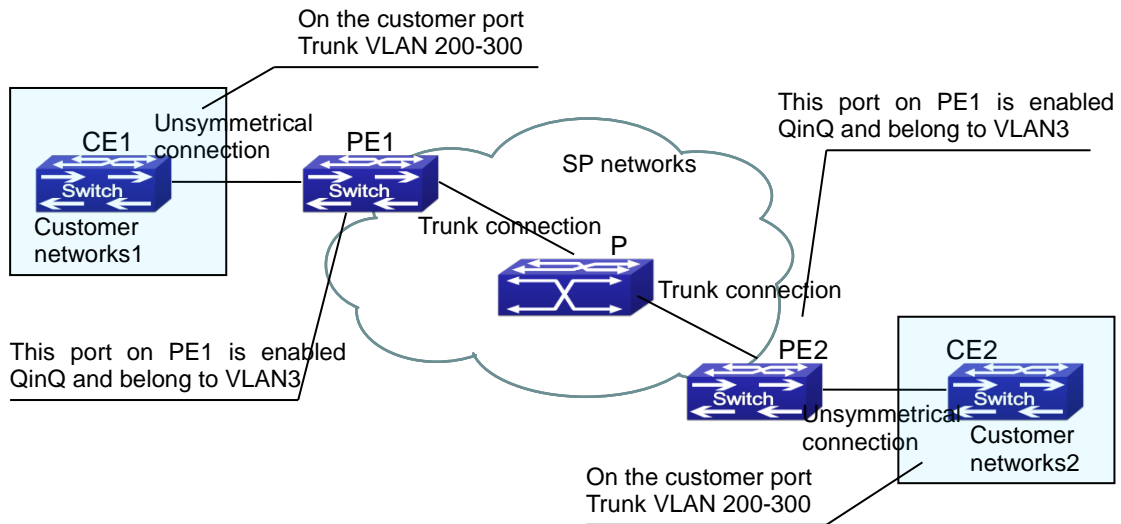

Figure 15-7 Vlan translation topology mode

Configuration Item	Configuration Explanation
VLAN-translation	Port1 of PE1 and PE2.
Trunk port	Port1 and Port10 of PE1 and PE2.

---

Configuration procedure is as follows:

**PE1 、 PE2:**

```
switch(Config)#interface ethernet 1/0/1
switch(Config-Ethernet1/0/1)#switchport mode trunk
switch(Config-Ethernet1/0/1)# vlan-translation enable
switch(Config-Ethernet1/0/1)# vlan-translation 20 to 3 in
switch(Config-Ethernet1/0/1)# vlan-translation 3 to 20 out
switch(Config-Ethernet1/0/1)# exit
switch(Config)#interface ethernet 1/0/1
switch(Config-Ethernet1/0/1)#switchport mode trunk
switch(Config-Ethernet1/0/1)#exit
switch(Config)#
```

## 15.4.4 VLAN-translation Troubleshooting

Normally the VLAN-translation is applied on trunk ports.

Priority of vlan translation and vlan ingress filtering for processing packets is: vlan translation > vlan ingress filtering

## 15.5 Dynamic VLAN Configuration

### 15.5.1 Introduction to Dynamic VLAN

The dynamic VLAN is named corresponding to the static VLAN (namely the port based VLAN). Dynamic VLAN supported by the switch includes MAC-based VLAN, IP-subnet-based VLAN and Protocol-based VLAN. Detailed description is as follows:

The MAC-based VLAN division is based on the MAC address of each host, namely every host with a MAC address will be assigned to certain VLAN. By the means, the network user will maintain his membership in his belonging VLAN when moves from a physical location to another. As we can see the greatest advantage of this VLAN division is that the VLAN does not have to be re-configured when the user physic location change, namely shift from one switch to another, which is because it is user based, not switch port based.

The IP subnet based VLAN is divided according to the source IP address and its subnet mask of every host. It assigns corresponding VLAN ID to the data packet according to the subnet segment, leading the data packet to specified VLAN. Its advantage is the same as that of the MAC-based VLAN: the user does not have to change configuration when relocated.

The VLAN is divided by the network layer protocol, assigning different protocol to different VLANs. This is very attractive to the network administrators who wish to organize the user by applications and services. Moreover the user can move freely within the network while maintaining his membership. Advantage of this method enables user to change physical position without changing their VLAN residing configuration, while the VLAN can be divided by types of protocols which is important to the network administrators. Further, this method has no need of added frame label to identify the VLAN which reduce the network traffic.

Notice: Dynamic VLAN needs to associate with Hybrid attribute of the ports to work, so the ports that may be added to a dynamic VLAN must be configured as Hybrid port.

## 15.5.2 Dynamic VLAN Configuration

Dynamic VLAN Configuration Task Sequence:

1. Configure the MAC-based VLAN function on the port
2. Set the VLAN to MAC VLAN
3. Configure the correspondence between the MAC address and the VLAN
4. Configure the IP-subnet-based VLAN function on the port
5. Configure the correspondence between the IP subnet and the VLAN
6. Configure the correspondence between the Protocols and the VLAN
7. Adjust the priority of the dynamic VLAN

### 1. Configure the MAC-based VLAN function on the port

Command	Explanation
Port Mode	
<b>switchport mac-vlan enable</b> <b>no switchport mac-vlan enable</b>	Enable/disable the MAC-based VLAN function on the port.

### 2. Set the VLAN to MAC VLAN

Command	Explanation
Global Mode	
<b>mac-vlan vlan &lt;vlan-id&gt;</b> <b>no mac-vlan</b>	Configure the specified VLAN to MAC VLAN; the “ <b>no mac-vlan</b> ” command cancels the MAC VLAN configuration of this VLAN.

### 3. Configure the correspondence between the MAC address and the VLAN

Command	Explanation
Global Mode	
<b>mac-vlan mac &lt;mac-addrss&gt; vlan &lt;vlan-id&gt; priority &lt;priority-id&gt;</b> <b>no mac-vlan {mac &lt;mac-addrss&gt; all}</b>	Add/delete the correspondence between the MAC address and the VLAN, namely specified MAC address join/leave specified VLAN.

### 4. Configure the IP-subnet-based VLAN function on the port

Command	Explanation
Port Mode	
<b>switchport subnet-vlan enable</b> <b>no switchport subnet-vlan enable</b>	Enable/disable the port IP-subnet-base VLAN function on the port.

## 5. Configure the correspondence between the IP subnet and the VLAN

Command	Explanation
Global Mode	
<b>subnet-vlan ip-address &lt;ipv4-addrss&gt; mask &lt;subnet-mask&gt; vlan &lt;vlan-id&gt; priority &lt;priority-id&gt; no subnet-vlan {ip-address &lt;ipv4-addrss&gt; mask &lt;subnet-mask&gt; all}</b>	Add/delete the correspondence between the IP subnet and the VLAN, namely specified IP subnet joins/leaves specified VLAN.

## 6. Configure the correspondence between the Protocols and the VLAN

Command	Explanation
Global Mode	
<b>protocol-vlan mode {ethernetii etype &lt;etype-id&gt; llc {dsap &lt;dsap-id&gt; ssap &lt;ssap-id&gt;} snap etype &lt;etype-id&gt;} vlan &lt;vlan-id&gt; priority &lt;priority-id&gt; no protocol-vlan {mode {ethernetii etype &lt;etype-id&gt; llc {dsap &lt;dsap-id&gt; ssap &lt;ssap-id&gt;} snap etype &lt;etype-id&gt;} all}</b>	Add/delete the correspondence between the Protocols and the VLAN, namely specified protocol joins/leaves specified VLAN.

## 7. Adjust the priority of the dynamic VLAN

Command	Explanation
Global Mode	
<b>dynamic-vlan mac-vlan prefer dynamic-vlan subnet-vlan prefer</b>	Configure the priority of the dynamic VLAN.

## 15.5.3 Typical Application of the Dynamic VLAN

### Scenario:

In the office network Department A belongs to VLAN100. Several members of this department often have the need to move within the whole office network. It is also required to ensure the resource for other members of the department to access VLAN 100. Assume one of the members is M, the MAC address of his PC is 00-30-4f-11-22-33, when M moves to VLAN200 or VLAN300, the port connecting M is configured as Hybrid mode and belongs to VLAN100 with untag mode. In this way, the data of VLAN100 will be forwarded to the port connecting M, and implement the communication requirement in VLAN100.

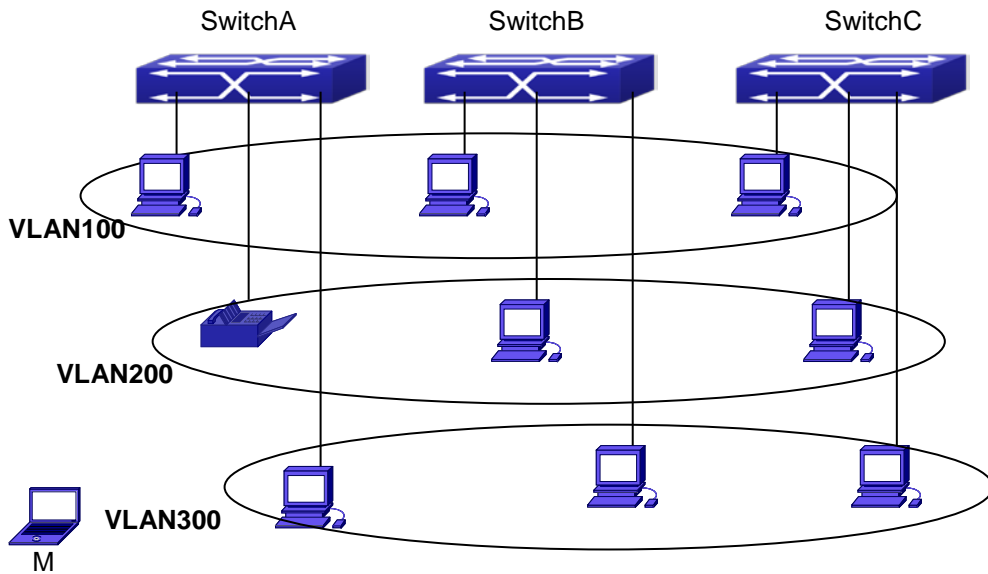

Figure 15-8 Typical topology application of dynamic VLAN

Configuration Items	Configuration Explanation
MAC-based VLAN	Global configuration on Switch A, Switch B, Switch C.

For example, M at E1/0/1 of SwitchA, then the configuration procedures are as follows:

**Switch A, Switch B, Switch C:**

```
SwitchA (Config)#mac-vlan mac 00-03-0f-11-22-33 vlan 100 priority 0
SwitchA (Config)#interface ethernet 1/0/1
SwitchA (Config-Ethernet1/0/1)# swportport mode hybrid
SwitchA (Config-Ethernet1/0/1)# swportport hybrid allowed vlan 100 untagged
```

```
SwitchB (Config)#mac-vlan mac 00-30-4f-11-22-33 vlan 100 priority 0
SwitchB (Config)#exit
SwitchB#
```

```
SwitchC (Config)#mac-vlan mac 00-30-4f-11-22-33 vlan 100 priority 0
SwitchC (Config)#exit
SwitchC#
```



## 15.5.4 Dynamic VLAN Troubleshooting

- On the switch configured with dynamic VLAN, if the two connected equipment (e.g. PC) are both belongs to the same dynamic VLAN, first communication between the two equipments may not go through. The solution will be letting the two equipments positively send data packet to the switch (such as ping), to let the switch learn their source MAC, then the two equipments will be able to communicate freely within the dynamic VLAN.

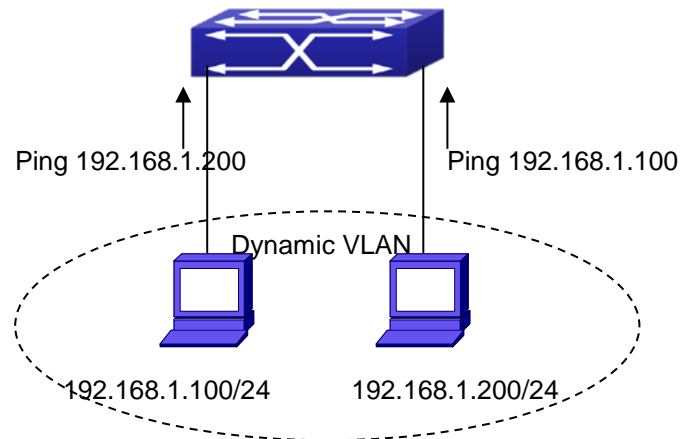

Figure 15-9 Dynamic VLAN Troubleshooting

- Priority of dynamic vlan and vlan ingress filtering for processing packets is: dynamic vlan > vlan ingress filtering

## 15.6 Voice VLAN Configuration

### 15.6.1 Introduction to Voice VLAN

Voice VLAN is specially configured for the user voice data traffic. By setting a Voice VLAN and adding the ports of the connected voice equipments to the Voice VLAN, the user will be able to configure QoS (Quality of service) service for voice data, and improve the voice data traffic transmission priority to ensure the calling quality.

The switch can judge if the data traffic is the voice data traffic from specified equipment according to the source MAC address field of the data packet entering the port. The packet with the source MAC address complying with the system defined voice equipment **OUI (Organizationally Unique Identifier)** will be considered the voice data traffic and transmitted to the Voice VLAN.

The configuration is based on MAC address, acquiring a mechanism in which every voice equipment transmitting information through the network has got its unique MAC address. VLAN will trace the address belongs to specified MAC. By This means, VLAN allows the voice equipment always belong to Voice VLAN when relocated physically. The greatest advantage of the VLAN is the equipment can be automatically placed into Voice VLAN according to its voice traffic which will be transmitted at specified priority. Meanwhile, when voice equipment is physically relocated, it still belongs to the Voice VLAN without any further configuration modification, which is because it is based on voice equipment other than switch port.

Notice: Voice VLAN needs to associate with Hybrid attribute of the ports to work, so the ports that may be added to Voice VLAN must be configured as Hybrid port.

## 15.6.2 Voice VLAN Configuration

Voice VLAN Configuration Task Sequence:

1. Set the VLAN to Voice VLAN
2. Add a voice equipment to Voice VLAN
3. Enable the Voice VLAN on the port

### 1. Configure the VLAN to Voice VLAN

Command	Explanation
Global Mode	
<b>voice-vlan vlan &lt;vlan-id&gt;</b> <b>no voice-vlan</b>	Set/cancel the VLAN as a Voice VLAN

### 2. Add a Voice equipment to a Voice VLAN

Command	Explanation
Global Mode	
<b>voice-vlan mac &lt;mac-address&gt; mask &lt;mac-mask&gt; priority &lt;priority-id&gt; [name &lt;voice-name&gt;]</b> <b>no voice-vlan {mac &lt;mac-address&gt; mask &lt;mac-mask&gt; name &lt;voice-name&gt;  all}</b>	Specify certain voice equipment join/leave the Voice VLAN

### 3. Enable the Voice VLAN of the port

Command	Explanation
Port Mode	
<b>switchport voice-vlan enable</b> <b>no switchport voice-vlan enable</b>	Enable/disable the Voice VLAN function on the port

## 15.6.3 Typical Applications of the Voice VLAN

### Scenario:

A company realizes voice communication through configuring Voice VLAN. IP-phone1 and IP-phone2 can be connected to any port of the switch, namely normal communication and interconnected with other switches through the uplink port. IP-phone1 MAC address is 00-30-4f-11-22-33, connect port 1/0/1 of the switch, IP-phone2 MAC address is 00-30-4f-11-22-55, connect port 1/0/2 of the switch,.

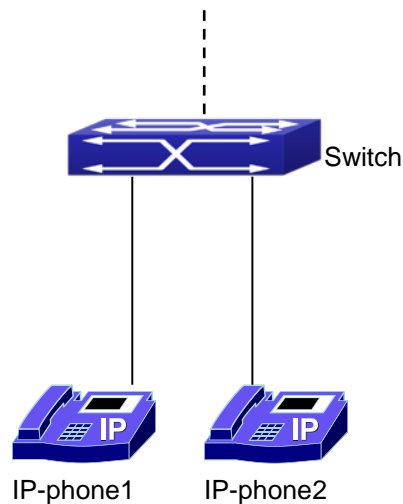

Figure 15-9 VLAN typical apply topology Figure

Configuration items	Configuration Explanation
Voice VLAN	Global configuration on the Switch.

Configuration procedure:

### Switch 1:

```
Switch(config)#vlan 100
Switch(Config-Vlan100)#exit
Switch(config)#voice-vlan vlan 100
Switch(config)#voice-vlan mac 00-30-4f-11-22-33 mask 255 priority 5 name company
Switch(config)#voice-vlan mac 00-30-4f-11-22-55 mask 255 priority 5 name company
Switch(config)#interface ethernet 1/0/10
Switch(Config-If-Ethernet1/0/10)#switchport mode trunk
Switch(Config-If-Ethernet1/0/10)#exit
Switch(Config)#interface ethernet 1/0/1
Switch(Config-If-Ethernet1/0/1)#switchport mode hybrid
Switch(Config-If-Ethernet1/0/1)#switchport hybrid allowed vlan 100 untag
Switch(Config-If-Ethernet1/0/1)#exit
Switch(Config)#interface ethernet 1/0/2
Switch(Config-If-Ethernet1/0/2)#switchport mode hybrid
Switch(Config-If-Ethernet1/0/2)#switchport hybrid allowed vlan 100 untag
Switch(Config-If-Ethernet1/0/2)#exit
```

---

## 15.6.4 Voice VLAN Troubleshooting

- Voice VLAN can not be applied concurrently with MAC-base VLAN.
- The Voice VLAN on the port is enabled by default. If the configured data can no longer enter the Voice VLAN during operation, please check if the Voice VLAN function has been disabled on the port.

---

# Chapter 16 MAC Table Configuration

## 16.1 Introduction to MAC Table

MAC table is a table identifies the mapping relationship between destination MAC addresses and switch ports. MAC addresses can be categorized as static MAC addresses and dynamic MAC addresses. Static MAC addresses are manually configured by the user, have the highest priority and are permanently effective (will not be overwritten by dynamic MAC addresses); dynamic MAC addresses are entries learnt by the switch in data frame forwarding, and is effective for a limited period. When the switch receives a data frame to be forwarded, it stores the source MAC address of the data frame and creates a mapping to the destination port. Then the MAC table is queried for the destination MAC address, if hit, the data frame is forwarded in the associated port, otherwise, the switch forwards the data frame to its broadcast domain. If a dynamic MAC address is not learnt from the data frames to be forwarded for a long time, the entry will be deleted from the switch MAC table.

There are two MAC table operations:

1. Obtain a MAC address.
2. Forward or filter data frame according to the MAC table.

### 16.1.1 Obtaining MAC Table

The MAC table can be built up statically and dynamically. Static configuration is to set up a mapping between the MAC addresses and the ports; dynamic learning is the process in which the switch learns the mapping between MAC addresses and ports, and updates the MAC table regularly. In this section, we will focus on the dynamic learning process of MAC table.

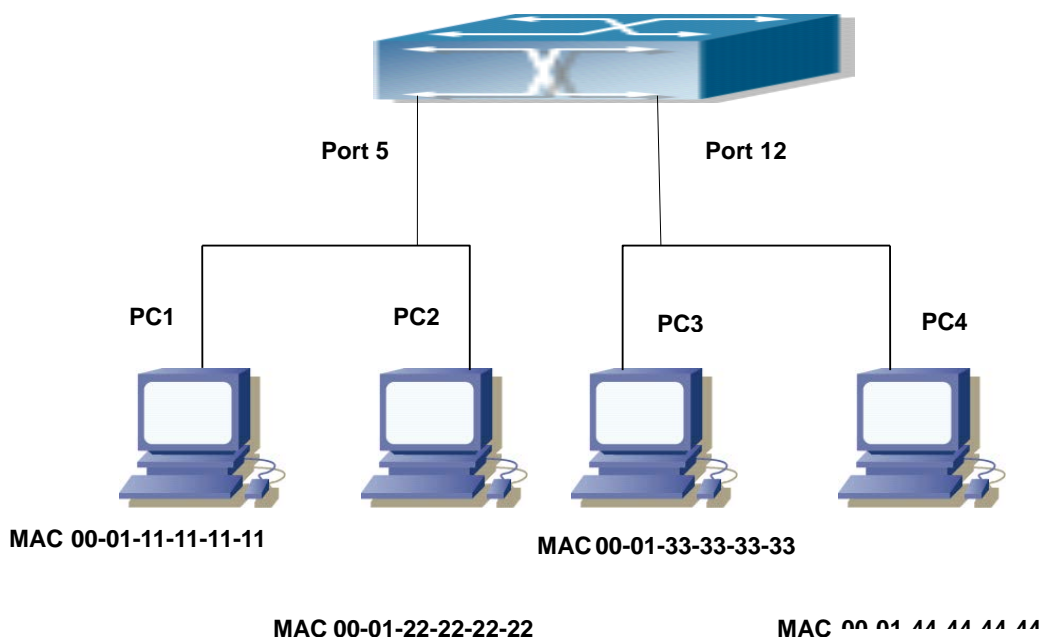

Figure 16-1 MAC Table dynamic learning

The topology of the figure above: 4 PCs connected to switch, where PC1 and PC2 belongs to a same physical segment (same collision domain), the physical segment connects to port 1/0/5 of switch; PC3 and PC4 belongs to the same physical segment that connects to port 1/0/12 of switch.

The initial MAC table contains no address mapping entries. Take the communication of PC1 and PC3 as an example, the MAC address learning process is as follow:

1. When PC1 sends message to PC3, the switch receives the source MAC address 00-01-11-11-11-11 from this message, the mapping entry of 00-01-11-11-11-11 and port 1/0/5 is added to the switch MAC table.
2. At the same time, the switch learns the message is destined to 00-01-33-33-33-33, as the MAC table contains only a mapping entry of MAC address 00-01-11-11-11-11 and port1/0/5, and no port mapping for 00-01-33-33-33-33 present, the switch broadcast this message to all the ports in the switch (assuming all ports belong to the default VLAN1).
3. PC3 and PC4 on port 1/0/12 receive the message sent by PC1, but PC4 will not reply, as the destination MAC address is 00-01-33-33-33-33, only PC3 will reply to PC1. When port 1/0/12 receives the message sent by PC3, a mapping entry for MAC address 00-01-33-33-33-33 and port 1/0/12 is added to the MAC table.
4. Now the MAC table has two dynamic entries, MAC address 00-01-11-11-11-11 - port 1/0/5 and 00-01-33-33-33-33 -port1/0/12.
5. After the communication between PC1 and PC3, the switch does not receive any message sent from PC1 and PC3. And the MAC address mapping entries in the MAC table are deleted in 300 to 2\*300 seconds (ie, in single to double aging time). The 300 seconds here is the default aging time for MAC address entry in switch. Aging time can be modified in switch.

## 16.1.2 Forward or Filter

The switch will forward or filter received data frames according to the MAC table. Take the above figure as an example, assuming switch have learnt the MAC address of PC1 and PC3, and the user manually configured the mapping relationship for PC2 and PC4 to ports. The MAC table of switch will be:

MAC Address	Port number	Entry added by
00-01-11-11-11-11	1/0/5	Dynamic learning
00-01-22-22-22-22	1/0/5	Static configuration
00-01-33-33-33-33	1/0/12	Dynamic learning
00-01-44-44-44-44	1/0/12	Static configuration

### 1 · Forward data according to the MAC table

If PC1 sends a message to PC3, the switch will forward the data received on port 1/0/5 from port1/0/12.

### 2 · Filter data according to the MAC table

If PC1 sends a message to PC2, the switch, on checking the MAC table, will find PC2 and PC1 are in the same physical segment and filter the message (i.e. drop this message).

---

Three types of frames can be forwarded by the switch:

- Broadcast frame
- Multicast frame
- Unicast frame

The following describes how the switch deals with all the three types of frames:

- Broadcast frame: The switch can segregate collision domains but not broadcast domains. If no VLAN is set, all devices connected to the switch are in the same broadcast domain. When the switch receives a broadcast frame, it forwards the frame in all ports. When VLANs are configured in the switch, the MAC table will be adapted accordingly to add VLAN information. In this case, the switch will not forward the received broadcast frames in all ports, but forward the frames in all ports in the same VLAN.
- Multicast frame: When IGMP Snooping function is not enabled, multicast frames are processed in the same way as broadcast frames; when IGMP Snooping is enabled, the switch will only forward the multicast frames to the ports belonging to the very multicast group.
- Unicast frame: When no VLAN is configured, if the destination MAC addresses are in the switch MAC table, the switch will directly forward the frames to the associated ports; when the destination MAC address in a unicast frame is not found in the MAC table, the switch will broadcast the unicast frame. When VLANs are configured, the switch will forward unicast frame within the same VLAN. If the destination MAC address is found in the MAC table but belonging to different VLANs, the switch can only broadcast the unicast frame in the VLAN it belongs to.

## 16.2 Mac Address Table Configuration Task List

1. Configure the MAC address aging-time
2. Configure static MAC forwarding or filter entry
3. Clear dynamic address table

### 1. Configure the MAC aging-time

Command	Explanation
Global Mode	
<b>mac-address-table aging-time</b> <i>&lt;0/aging-time&gt;</i> <b>no mac-address-table aging-time</b>	Configure the MAC address aging-time.

## 2. Configure static MAC forwarding or filter entry

Command	Explanation
Global Mode	
<pre>mac-address-table {static   blackhole} address &lt;mac-addr&gt; vlan &lt;vlan-id &gt; [interface [ethernet   portchannel] &lt;interface-name&gt;]   [source destination both] no mac-address-table {static   blackhole   dynamic} [address &lt;mac-addr&gt;] [vlan &lt;vlan-id&gt;] [interface [ethernet   portchannel] &lt;interface-name&gt;]</pre>	Configure static MAC forwarding or filter entry.

## 3. Clear dynamic address table

Command	Explanation
Admin Mode	
<pre>clear mac-address-table dynamic [address &lt;mac-addr&gt;] [vlan &lt;vlan-id&gt;] [interface [ethernet   portchannel] &lt;interface-name&gt;]</pre>	Clear the dynamic address table.

## 16.3 Typical Configuration Examples

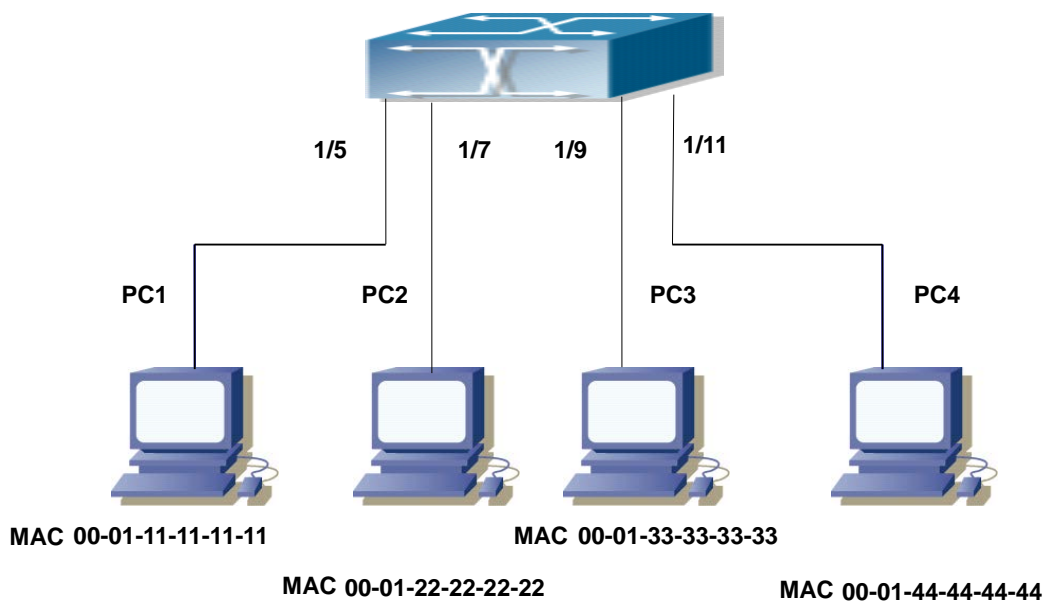

Figure 16-2 MAC Table typical configuration example



---

**Scenario:**

Four PCs as shown in the above figure connect to port 1/0/5、1/0/7、1/0/9、1/0/11 of switch, all the four PCs belong to the default VLAN1. As required by the network environment, dynamic learning is enabled. PC1 holds sensitive data and can not be accessed by any other PC that is in another physical segment; PC2 and PC3 have static mapping set to port 7 and port 9, respectively.

The configuration steps are listed below:

1. Set the MAC address 00-01-11-11-11-11 of PC1 as a filter address.

```
Switch(config)#mac-address-table static 00-01-11-11-11-11 discard vlan 1.
```

2. Set the static mapping relationship for PC2 and PC3 to port 7 and port 9, respectively.

```
Switch(config)#mac-address-table static 00-01-22-22-22-22 interface ethernet 1/0/7 vlan 1
```

```
Switch(config)#mac-address-table static 00-01-33-33-33-33 interface ethernet 1/0/9 vlan 1
```

## 16.4 MAC Table Troubleshooting

Using the show mac-address-table command, a port is found to be failed to learn the MAC of a device connected to it. Possible reasons:

- The connected cable is broken.
- Spanning Tree is enabled and the port is in “discarding” status; or the device is just connected to the port and Spanning Tree is still under calculation, wait until the Spanning Tree calculation finishes, and the port will learn the MAC address.
- If not the problems mentioned above, please check for the switch port and contact technical support for solution.

## 16.5 MAC Address Function Extension

### 16.5.1 MAC Address Binding

#### 16.5.1.1 Introduction to MAC Address Binding

Most switches support MAC address learning, each port can dynamically learn several MAC addresses, so that forwarding data streams between known MAC addresses within the ports can be achieved. If a MAC address is aged, the packet destined for that entry will be broadcasted. In other words, a MAC address learned in a port will be used for forwarding in that port, if the connection is changed to another port, the switch will learn the MAC address again to forward data in the new port.

However, in some cases, security or management policy may require MAC addresses to be bound with the ports, only data stream from the binding MAC are allowed to be forwarded in the ports. That is to say, after a MAC address is bound to a port, only the data stream destined for that MAC address can flow in from the binding port, data stream destined for the other MAC addresses that not bound to the port will not be allowed to pass through the port.

## 16.5.1.2 MAC Address Binding Configuration Task List

1. Enable MAC address binding function for the ports
2. Lock the MAC addresses for a port
3. MAC address binding property configuration
4. mac-notification trap configuration

### 1. Enable MAC address binding function for the ports

Command	Explanation
Port Mode	
<b>switchport port-security</b> <b>no switchport port-security</b>	Enable MAC address binding function for the port and lock the port. When a port is locked, the MAC address learning function for the port will be disabled: the “ <b>no switchport port-security</b> ” command disables the MAC address binding function for the port, and restores the MAC address learning function for the port.

### 2. Lock the MAC addresses for a port

Command	Explanation
Port Mode	
<b>switchport port-security lock</b> <b>no switchport port-security lock</b>	Lock the port, then MAC addresses learned will be disabled. The “ <b>no switchport port-security lock</b> ” command restores the function.
<b>switchport port-security convert</b>	Convert dynamic secure MAC addresses learned by the port to static secure MAC addresses.
<b>switchport port-security timeout &lt;value&gt;</b> <b>no switchport port-security timeout</b>	Enable port locking timer function; the “ <b>no switchport port-security timeout</b> ” restores the default setting.
<b>switchport port-security mac-address &lt;mac-address&gt;</b> <b>no switchport port-security mac-address &lt;mac-address&gt;</b>	Add static secure MAC address; the “ <b>no switchport port-security mac-address</b> ” command deletes static secure MAC address.
Admin Mode	
<b>clear port-security dynamic [address &lt;mac-addr&gt;   interface &lt;interface-id&gt;]</b>	Clear dynamic MAC addresses learned by the specified port.

### 3. MAC address binding property configuration

Command	Explanation
Port Mode	
<b>switchport port-security maximum</b> <i>&lt;value&gt;</i> <b>no switchport port-security maximum</b> <i>&lt;value&gt;</i>	Set the maximum number of secure MAC addresses for a port; the “ <b>no switchport port-security maximum</b> ” command restores the default value.
<b>switchport port-security violation</b> {protect   shutdown} <b>no switchport port-security violation</b>	Set the violation mode for the port; the “ <b>no switchport port-security violation</b> ” command restores the default setting.

### 4. mac-notification trap configuration

Command	Explanation
Global Mode	
<b>mac-address-table</b> <b>periodic-monitor-time</b> <i>&lt;5-86400&gt;</i>	Set the MAC monitor interval to count the added and deleted MAC in time, and send out them with trap message.

## 16.5.1.3 Binding MAC Address Binding Troubleshooting

Enabling MAC address binding for ports may fail in some occasions. Here are some possible causes and solutions:

- If MAC address binding cannot be enabled for a port, make sure the port is not enabling port aggregation and is not configured as a Trunk port. MAC address binding is exclusive to such configurations. If MAC address binding is to be enabled, the functions mentioned above must be disabled first.
- If a secure address is set as static address and deleted, that secure address will be unusable even though it exists. For this reason, it is recommended to avoid static address for ports enabling MAC address.

---

# Chapter 17 MSTP Configuration

## 17.1 Introduction to MSTP

The MSTP (Multiple STP) is a new spanning-tree protocol which is based on the STP and the RSTP. It runs on all the bridges of a bridged-LAN. It calculates a common and internal spanning tree (CIST) for the bridge-LAN which consists of the bridges running the MSTP, the RSTP and the STP. It also calculates the independent multiple spanning-tree instances (MSTI) for each MST domain (MSTP domain). The MSTP, which adopts the RSTP for its rapid convergence of the spanning tree, enables multiple VLANs to be mapped to the same spanning-tree instance which is independent to other spanning-tree instances. The MSTP provides multiple forwarding paths for data traffic and enables load balancing. Moreover, because multiple VLANs share a same MSTI, the MSTP can reduce the number of spanning-tree instances, which consumes less CPU resources and reduces the bandwidth consumption.

### 17.1.1 MSTP Region

Because multiple VLANs can be mapped to a single spanning tree instance, IEEE 802.1s committee raises the MST concept. The MST is used to make the association of a certain VLAN to a certain spanning tree instance.

A MSTP region is composed of one or multiple bridges with the same MCID (MST Configuration Identification) and the bridged-LAN (a certain bridge in the MSTP region is the designated bridge of the LAN, and the bridges attaching to the LAN are not running STP). All the bridges in the same MSTP region have the same MSID.

MSID consists of 3 attributes:

- Configuration Name: Composed by digits and letters
- Revision Level
- Configuration Digest: VLANs mapping to spanning tree instances

The bridges with the same 3 above attributes are considered as in the same MST region.

When the MSTP calculates CIST in a bridged-LAN, a MSTP region is considered as a bridge. See the figure below:

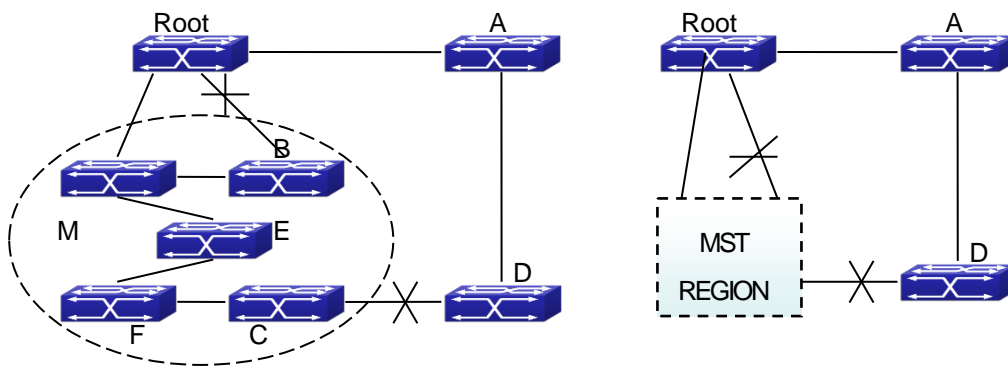

**Figure 17-1** Example of CIST and MST Region

In the above network, if the bridges are running the STP or the RSTP, one port between Bridge M and Bridge B should be blocked. But if the bridges in the yellow range run the MSTP and are configured in the same MST region, MSTP will treat this region as a bridge. Therefore, one port between Bridge B and Root is blocked and one port on Bridge D is blocked.

### 17.1.1.1 Operations within an MSTP Region

The IST connects all the MSTP bridges in a region. When the IST converges, the root of the IST becomes the IST master, which is the switch within the region with the lowest bridge ID and path cost to the CST root. The IST master is also the CST root if there is only one region within the network. If the CST root is outside the region, one of the MSTP bridges at the boundary of the region is selected as the IST master.

When an MSTP bridge initializes, it sends BPDUs claiming itself as the root of the CST and the IST master, with both of the path costs to the CST root and to the IST master set to zero. The bridge also initializes all of its MST instances and claims to be the root for all of them. If the bridge receives superior MST root information (lower bridge ID, lower path cost, and so forth) than currently stored for the port, it relinquishes its claim as the IST master.

Within a MST region, the IST is the only spanning-tree instance that sends and receives BPDUs. Because the MST BPDUs carry information for all instances, the number of BPDUs that need to be processed by a switch to support multiple spanning-tree instances is significantly reduced.

All MST instances within the same region share the same protocol timers, but each MST instance has its own topology parameters, such as root switch ID, root path cost, and so forth.

### 17.1.1.2 Operations between MST Regions

If there are multiple regions or legacy 802.1D bridges within the network, MSTP establishes and maintains the CST, which includes all MST regions and all legacy STP bridges in the network. The MST instances combine with the IST at the boundary of the region to become the CST.

The MSTI is only valid within its MST region. An MSTI has nothing to do with MSTIs in other MST regions. The bridges in a MST region receive the MST BPDUs of other regions through Boundary Ports. They only process CIST related information and abandon MSTI information.

---

## 17.1.2 Port Roles

The MSTP bridge assigns a port role to each port which runs MSTP.

- CIST port roles: Root Port, Designated Port, Alternate Port and Backup Port
- On top of those roles, each MSTI port has one new role: Master Port.

The port roles in the CIST (Root Port, Designated Port, Alternate Port and Backup Port) are defined in the same ways as those in the RSTP.

## 17.1.3 MSTP Load Balance

In a MSTP region, VLANs can be mapped to various instances. That can form various topologies. Each instance is independent from the others and each instance can have its own attributes such as bridge priority and port cost etc. Consequently, the VLANs in different instances have their own paths. The traffic of the VLANs are load-balanced.

## 17.2 MSTP Configuration Task List

MSTP configuration task list:

1. Enable the MSTP and set the running mode
2. Configure instance parameters
3. Configure MSTP region parameters
4. Configure MSTP time parameters
5. Configure the fast migrate feature for MSTP
6. Configure the format of port packet
7. Configure the spanning-tree attribute of port
8. Configure the snooping attribute of authentication key
9. Configure the FLUSH mode once topology changes

### 1. Enable MSTP and set the running mode

Command	Explanation
Global Mode and Port Mode	
<b>spanning-tree</b> <b>no spanning-tree</b>	Enable/Disable MSTP.
Global Mode	
<b>spanning-tree mode {mstp stp rstp}</b> <b>no spanning-tree mode</b>	Set MSTP running mode.
Port Mode	
<b>spanning-tree mcheck</b>	Force port migrate to run under MSTP.

## 2. Configure instance parameters

Command	Explanation
Global Mode	
<b>spanning-tree mst &lt;instance-id&gt; priority &lt;bridge-priority&gt;</b> <b>no spanning-tree mst &lt;instance-id&gt; priority</b>	Set bridge priority for specified instance.
<b>spanning-tree priority &lt;bridge-priority&gt;</b> <b>no spanning-tree priority</b>	Configure the spanning-tree priority of the switch.
Port Mode	
<b>spanning-tree mst &lt;instance-id&gt; cost &lt;cost&gt;</b> <b>no spanning-tree mst &lt;instance-id&gt; cost</b>	Set port path cost for specified instance.
<b>spanning-tree mst &lt;instance-id&gt; port-priority &lt;port-priority&gt;</b> <b>no spanning-tree mst &lt;instance-id&gt; port-priority</b>	Set port priority for specified instance.
<b>spanning-tree mst &lt;instance-id&gt; rootguard</b> <b>no spanning-tree mst &lt;instance-id&gt; rootguard</b>	Configure currently port whether running rootguard in specified instance, configure the rootguard port can't turn to root port.
<b>spanning-tree rootguard</b> <b>no spanning-tree rootguard</b>	Configure currently port whether running rootguard in instance 0, configure the rootguard port can't turn to root port.
<b>spanning-tree [mst &lt;instance-id&gt;] loopguard</b> <b>no spanning-tree [mst &lt;instance-id&gt;] loopguard</b>	Enable loopguard function on specified instance, the no command disables this function.

### 3. Configure MSTP region parameters

Command	Explanation
Global Mode	
<b>spanning-tree mst configuration</b> <b>no spanning-tree mst configuration</b>	Enter MSTP region mode. The no command restores the default setting.
MSTP region mode	
<b>show</b>	Display the information of the current running system.
<b>instance &lt;instance-id&gt; vlan &lt;vlan-list&gt;</b> <b>no instance &lt;instance-id&gt; [vlan &lt;vlan-list&gt; ]</b>	Create Instance and set mapping between VLAN and Instance.
<b>name &lt;name&gt;</b> <b>no name</b>	Set MSTP region name.
<b>revision-level &lt;level&gt;</b> <b>no revision-level</b>	Set MSTP region revision level.
<b>abort</b>	Quit MSTP region mode and return to Global mode without saving MSTP region configuration.
<b>exit</b>	Quit MSTP region mode and return to Global mode with saving MSTP region configuration.
<b>no</b>	Cancel one command or set initial value.

### 4. Configure MSTP time parameters

Command	Explanation
Global Mode	
<b>spanning-tree forward-time &lt;time&gt;</b> <b>no spanning-tree forward-time</b>	Set the value for switch forward delay time.
<b>spanning-tree hello-time &lt;time&gt;</b> <b>no spanning-tree hello-time</b>	Set the Hello time for sending BPDU messages.
<b>spanning-tree maxage &lt;time&gt;</b> <b>no spanning-tree maxage</b>	Set Aging time for BPDU messages.
<b>spanning-tree max-hop &lt;hop-count&gt;</b> <b>no spanning-tree max-hop</b>	Set Maximum number of hops of BPDU messages in the MSTP region.



## 5. Configure the fast migrate feature for MSTP

Command	Explanation
Port Mode	
<b>spanning-tree link-type p2p</b> <b>{auto force-true force-false}</b> <b>no spanning-tree link-type</b>	Set the port link type.
<b>spanning-tree portfast [bpdudfilter  bpduguard] [recovery &lt;30-3600&gt;]</b> <b>no spanning-tree portfast</b>	Set and cancel the port to be an boundary port. bpdudfilter receives the BPDU discarding; bpduguard receives the BPDU will disable port; no parameter receives the BPDU, the port becomes a non-boundary port.

## 6. Configure the format of MSTP

Command	Explanation
Port Mode	
<b>spanning-tree format standard</b> <b>spanning-tree format privacy</b> <b>spanning-tree format auto</b> <b>no spanning-tree format</b>	Configure the format of port spanning-tree packet , standard format is provided by IEEE, privacy is compatible with CISCO and auto means the format is determined by checking the received packet.

## 7. Configure the spanning-tree attribute of port

Command	Explanation
Port Mode	
<b>spanning-tree cost</b> <b>no spanning-tree cost</b>	Set the port path cost.
<b>spanning-tree port-priority</b> <b>no spanning-tree port-priority</b>	Set the port priority.
<b>spanning-tree rootguard</b> <b>no spanning-tree rootguard</b>	Set the port is root port.
Global Mode	
<b>spanning-tree transmit-hold-count</b> <b>&lt;tx-hold-count-value&gt;</b> <b>no spanning-tree transmit-hold-count</b>	Set the max transmit-hold-count of port.

## 8. Configure the snooping attribute of authentication key

Command	Explanation
Port Mode	
<b>spanning-tree digest-snooping</b> <b>no spanning-tree digest-snooping</b>	Set the port to use the authentication string of partner port. The no restores to use the generated string.

## 9. Configure the FLUSH mode once topology changes

Command	Explanation
Global Mode	
<b>spanning-tree tflush {enable  disable  protect}</b> <b>no spanning-tree tflush</b>	Enable: the spanning-tree flush once the topology changes. Disable: the spanning tree don't flush when the topology changes. Protect: the spanning-tree flush not more than one time every ten seconds. The no command restores to default setting, enable flush once the topology changes.
Port Mode	
<b>spanning-tree tflush {enable  disable  protect}</b> <b>no spanning-tree tflush</b>	Configure the port flush mode. The no command restores to use the global configured flush mode.

## 17.3 MSTP Example

The following is a typical MSTP application example:

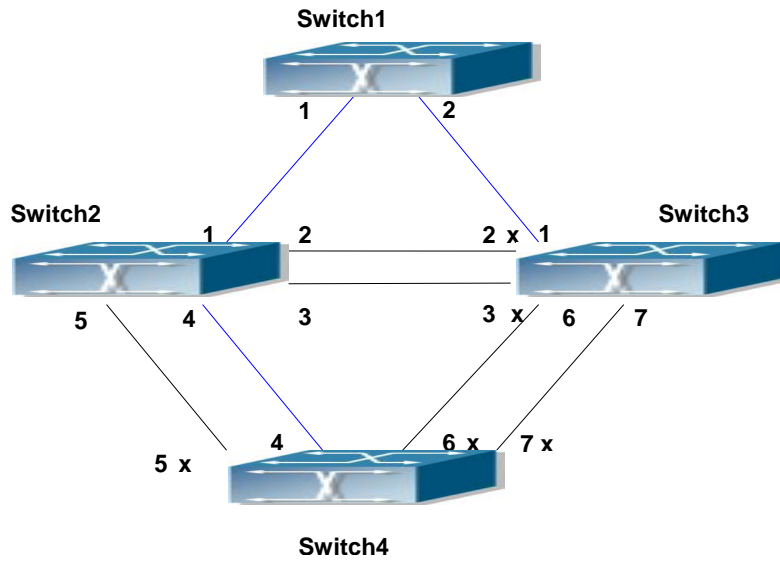

Figure 17-2 Typical MSTP Application Scenario

The connections among the switches are shown in the above figure. All the switches run in the MSTP mode by default, their bridge priority, port priority and port route cost are all in the default values (equal). The default configuration for switches is listed below:

Bridge Name		Switch1	Switch2	Switch3	Switch4
Bridge MAC Address		...00-00-01	...00-00-02	...00-00-03	...00-00-04
Bridge Priority		32768	32768	32768	32768
Port Priority	Port 1	128	128	128	
	Port 2	128	128	128	
	Port 3		128	128	
	Port 4		128		128
	Port 5		128		128
	Port 6			128	128
	Port 7			128	128
Route Cost	Port 1	200000	200000	200000	
	Port 2	200000	200000	200000	
	Port 3		200000	200000	
	Port 4		200000		200000
	Port 5		200000		200000
	Port 6			200000	200000
	Port 7			200000	200000

By default, the MSTP establishes a tree topology (in blue lines) rooted with SwitchA. The ports marked with “x” are in the discarding status, and the other ports are in the forwarding status.

---

Configurations Steps:

Step 1: Configure port to VLAN mapping:

- Create VLAN 20, 30, 40, 50 in Switch2, Switch3 and Switch4.
- Set ports 1-7 as trunk ports in Switch2 Switch3 and Switch4.

Step 2: Set Switch2, Switch3 and Switch4 in the same MSTP:

- Set Switch2, Switch3 and Switch4 to have the same region name as mstp.
- Map VLAN 20 and VLAN 30 in Switch2, Switch3 and Switch4 to Instance 3; Map VLAN 40 and VLAN 50 in Switch2, Switch3 and Switch4 to Instance 4.

Step 3: Set Switch3 as the root bridge of Instance 3; Set Switch4 as the root bridge of Instance 4

- Set the bridge priority of Instance 3 in Switch3 as 0.
- Set the bridge priority of Instance 4 in Switch4 as 0.

The detailed configuration is listed below:

**Switch2:**

```
Switch2(config)#vlan 20
Switch2(Config-Vlan20)#exit
Switch2(config)#vlan 30
Switch2(Config-Vlan30)#exit
Switch2(config)#vlan 40
Switch2(Config-Vlan40)#exit
Switch2(config)#vlan 50
Switch2(Config-Vlan50)#exit
Switch2(config)#spanning-tree mst configuration
Switch2(Config-Mstp-Region)#name mstp
Switch2(Config-Mstp-Region)#instance 3 vlan 20;30
Switch2(Config-Mstp-Region)#instance 4 vlan 40;50
Switch2(Config-Mstp-Region)#exit
Switch2(config)#interface e1/0/1-7
Switch2(Config-Port-Range)#switchport mode trunk
Switch2(Config-Port-Range)#exit
Switch2(config)#spanning-tree
```

---

**Switch3:**

```
Switch3(config)#vlan 20
Switch3(Config-Vlan20)#exit
Switch3(config)#vlan 30
Switch3(Config-Vlan30)#exit
Switch3(config)#vlan 40
Switch3(Config-Vlan40)#exit
Switch3(config)#vlan 50
Switch3(Config-Vlan50)#exit
Switch3(config)#spanning-tree mst configuration
Switch3(Config-Mstp-Region)#name mstp
Switch3(Config-Mstp-Region)#instance 3 vlan 20;30
Switch3(Config-Mstp-Region)#instance 4 vlan 40;50
Switch3(Config-Mstp-Region)#exit
Switch3(config)#interface e1/0/1-7
Switch3(Config-Port-Range)#switchport mode trunk
Switch3(Config-Port-Range)#exit
Switch3(config)#spanning-tree
Switch3(config)#spanning-tree mst 3 priority 0
```

**Switch4:**

```
Switch4(config)#vlan 20
Switch4(Config-Vlan20)#exit
Switch4(config)#vlan 30
Switch4(Config-Vlan30)#exit
Switch4(config)#vlan 40
Switch4(Config-Vlan40)#exit
Switch4(config)#vlan 50
Switch4(Config-Vlan50)#exit
Switch4(config)#spanning-tree mst configuration
Switch4(Config-Mstp-Region)#name mstp
Switch4(Config-Mstp-Region)#instance 3 vlan 20;30
Switch4(Config-Mstp-Region)#instance 4 vlan 40;50
Switch4(Config-Mstp-Region)#exit
Switch4(config)#interface e1/0/1-7
Switch4(Config-Port-Range)#switchport mode trunk
Switch4(Config-Port-Range)#exit
Switch4(config)#spanning-tree
Switch4(config)#spanning-tree mst 4 priority 0
```

After the above configuration, Switch1 is the root bridge of the instance 0 of the entire network. In the MSTP region which Switch2, Switch3 and Switch4 belong to, Switch2 is the region root of the instance 0, Switch3 is the region root of the instance 3 and Switch4 is the region root of the instance 4. The traffic of VLAN 20 and VLAN 30 is sent through the topology of the instance 3. The traffic of VLAN 40 and VLAN 50 is sent through the topology of the instance 4. And the traffic of other VLANs is sent through the topology of the instance 0. The port 1 in Switch2 is the master port of the instance 3 and the instance 4.

The MSTP calculation generates 3 topologies: the instance 0, the instance 3 and the instance 4 (marked with blue lines). The ports with the mark "x" are in the status of discarding. The other ports are the status of forwarding. Because the instance 3 and the instance 4 are only valid in the MSTP region, the following figure only shows the topology of the MSTP region.

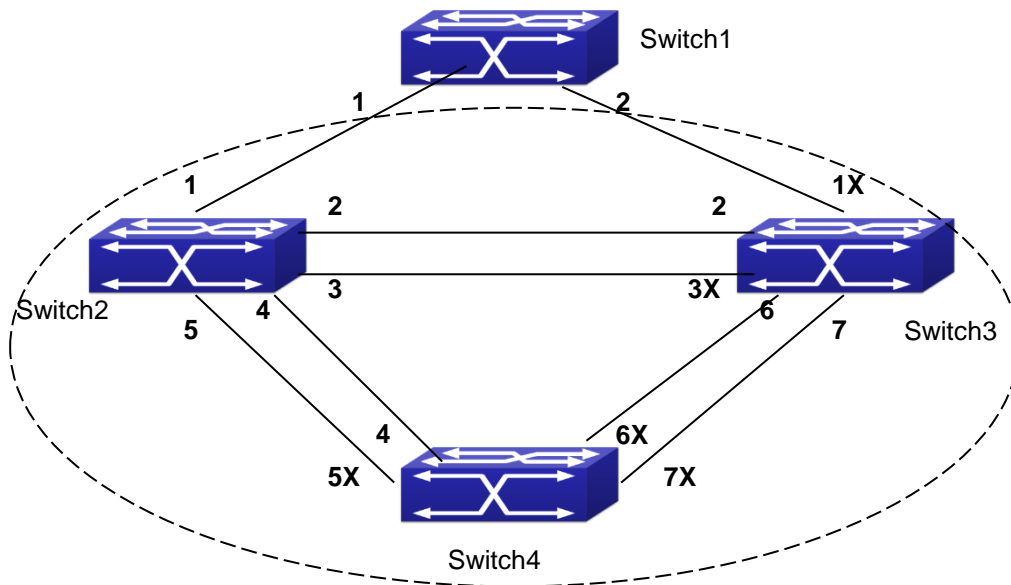

**Figure 17-3** The Topology Of the Instance 0 after the MSTP Calculation

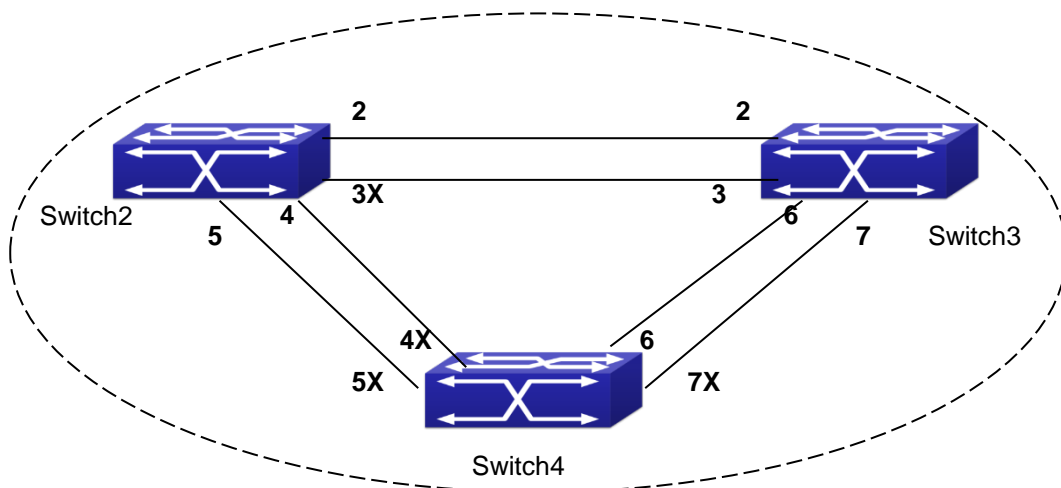

**Figure 17-4** The Topology Of the Instance 3 after the MSTP Calculation

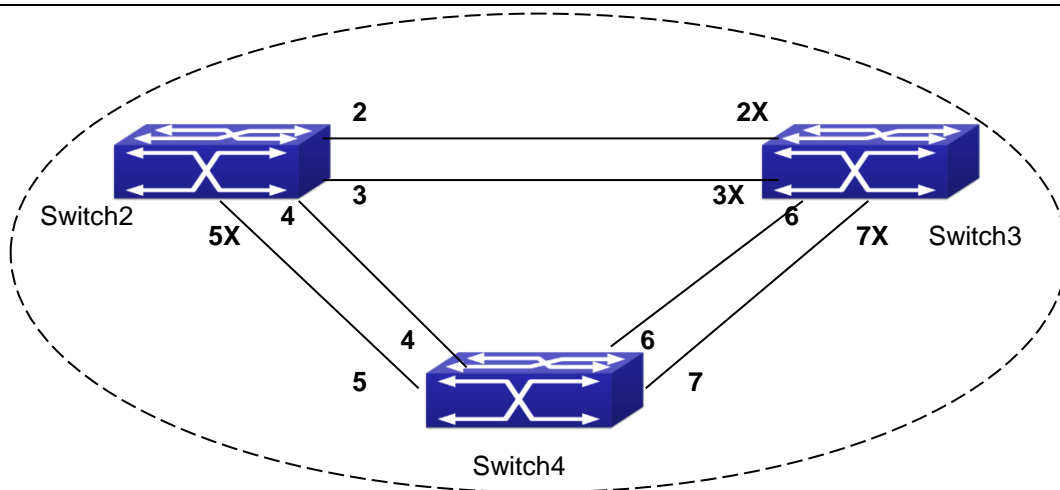

**Figure 17-5** The Topology Of the Instance 4 after the MSTP Calculation

## 17.4 MSTP Troubleshooting

- In order to run the MSTP on the switch port, the MSTP has to be enabled globally. If the MSTP is not enabled globally, it can't be enabled on the port.
- The MSTP parameters co work with each other, so the parameters should meet the following conditions. Otherwise, the MSTP may work incorrectly.

$$2 \times (\text{Bridge\_Forward\_Delay} - 1.0 \text{ seconds}) \geq \text{Bridge\_Max\_Age}$$

$$\text{Bridge\_Max\_Age} \geq 2 \times (\text{Bridge\_Hello\_Time} + 1.0 \text{ seconds})$$

- When users modify the MSTP parameters, they have to be sure about the changes of the topologies. The global configuration is based on the bridge. Other configurations are based on the individual instances.

---

# Chapter 18 QoS Configuration

## 18.1 Introduction to QoS

QoS (Quality of Service) is a set of capabilities that allow you to create differentiated services for network traffic, thereby providing better service for selected network traffic. QoS is a guarantee for service quality of consistent and predictable data transfer service to fulfill program requirements. QoS cannot generate extra bandwidth but provides more effective bandwidth management according to the application requirement and network management policy.

### 18.1.1 QoS Terms

**QoS:** Quality of Service, provides a guarantee for service quality of consistent and predictable data transfer service to fulfill program requirements. QoS cannot generate new bandwidth but provides more effective bandwidth management according to the application requirement and network management.

**QoS Domain:** QoS Domain supports QoS devices to form a net-topology that provides Quality of Service, so this topology is defined as QoS Domain.

**CoS:** Class of Service, the classification information carried by Layer 2 802.1Q frames, taking 3 bits of the Tag field in frame header, is called user priority level in the range of 0 to 7.

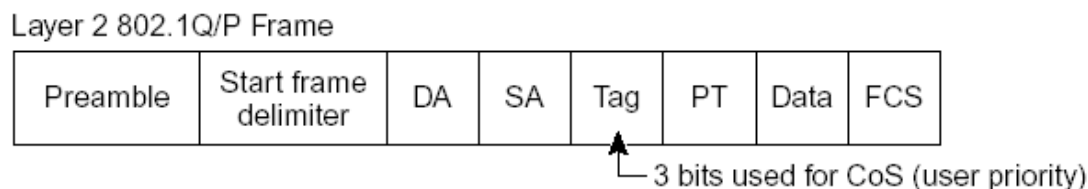

Figure 18-1 CoS priority

**ToS:** Type of Service, a one-byte field carried in Layer 3 IPv4 packet header to symbolize the service type of IP packets. Among ToS field can be IP Precedence value or DSCP value.

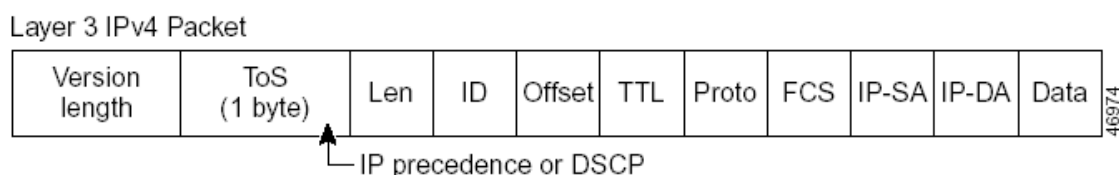

Figure 18-2 ToS priority

**IP Precedence:** IP priority. Classification information carried in Layer 3 IP packet header, occupying 3 bits, in the range of 0 to 7.

**DSCP:** Differentiated Services Code Point, classification information carried in Layer 3 IP packet header, occupying 6 bits, in the range of 0 to 63, and is downward compatible with IP Precedence.

**Internal Priority:** The internal priority setting of the switch chip, it's valid range relates with the chip, it's shortening is Int-Prio or IntP.



---

**Drop Precedence:** When processing the packets, firstly drop the packets with the bigger drop precedence, the ranging is 0-1. It's shortening is Drop-Prec or DP.

**Classification:** The entry action of QoS, classifying packet traffic according to the classification information carried in the packet and ACLs.

**Policing:** Ingress action of QoS that lays down the policing policy and manages the classified packets.

**Remark:** Ingress action of QoS, perform allowing, degrading or discarding operations to packets according to the policing policies.

**Scheduling:** QoS egress action. Add the packets to the corresponding egress queue according to the internal priority. And then decide sending and dropping according to Drop Precedence, sending algorithm and queue weight of egress queue.

## 18.1.2 QoS Implementation

To implement the switch software QoS, a general, mature reference model should be given. QoS can not create new bandwidth, but can maximize the adjustment and configuration for the current bandwidth resource. Fully implemented QoS can achieve complete management over the network traffic. The following is as accurate as possible a description of QoS.

The data transfer specifications of IP cover only addresses and services of source and destination, and ensure correct packet transmission using OSI layer 4 or above protocols such as TCP. However, rather than provide a mechanism for providing and protecting packet transmission bandwidth, IP provide bandwidth service by the best effort. This is acceptable for services like Mail and FTP, but for increasing multimedia business data and e-business data transmission, this best effort method cannot satisfy the bandwidth and low-lag requirement.

Based on differentiated service, QoS specifies a priority for each packet at the ingress. The classification information is carried in Layer 3 IP packet header or Layer 2 802.1Q frame header. QoS provides same service to packets of the same priority, while offers different operations for packets of different priority. QoS-enabled switch or router can provide different bandwidth according to the packet classification information, and can remark on the classification information according to the policing policies configured, and may discard some low priority packets in case of bandwidth shortage.

If devices of each hop in a network support differentiated service, an end-to-end QoS solution can be created. QoS configuration is flexible, the complexity or simplicity depends on the network topology and devices and analysis to incoming/outgoing traffic.

### 18.1.3 Basic QoS Model

The basic QoS consists of four parts: Classification, Policing, Remark and Scheduling, where classification, policing and remark are sequential ingress actions, and Queuing and Scheduling are QoS egress actions.

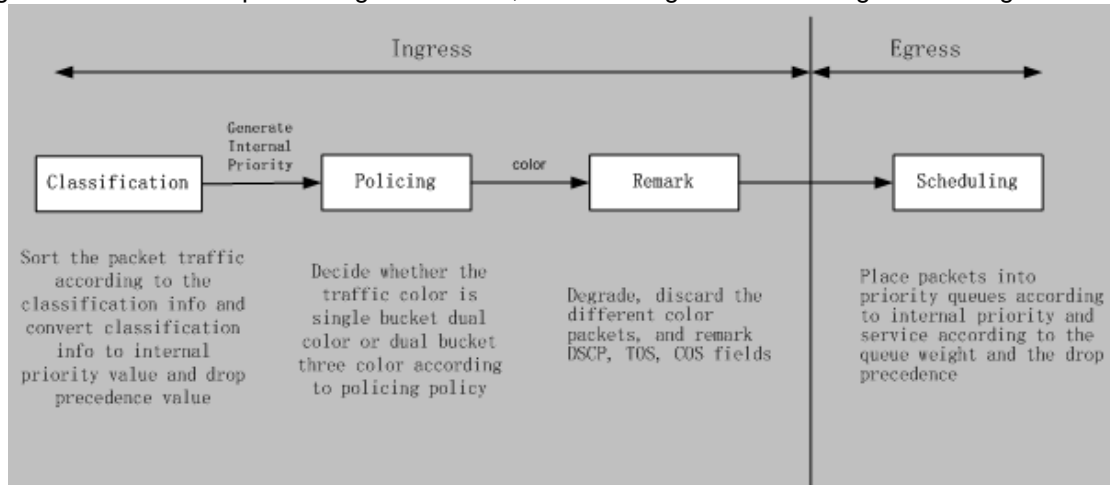
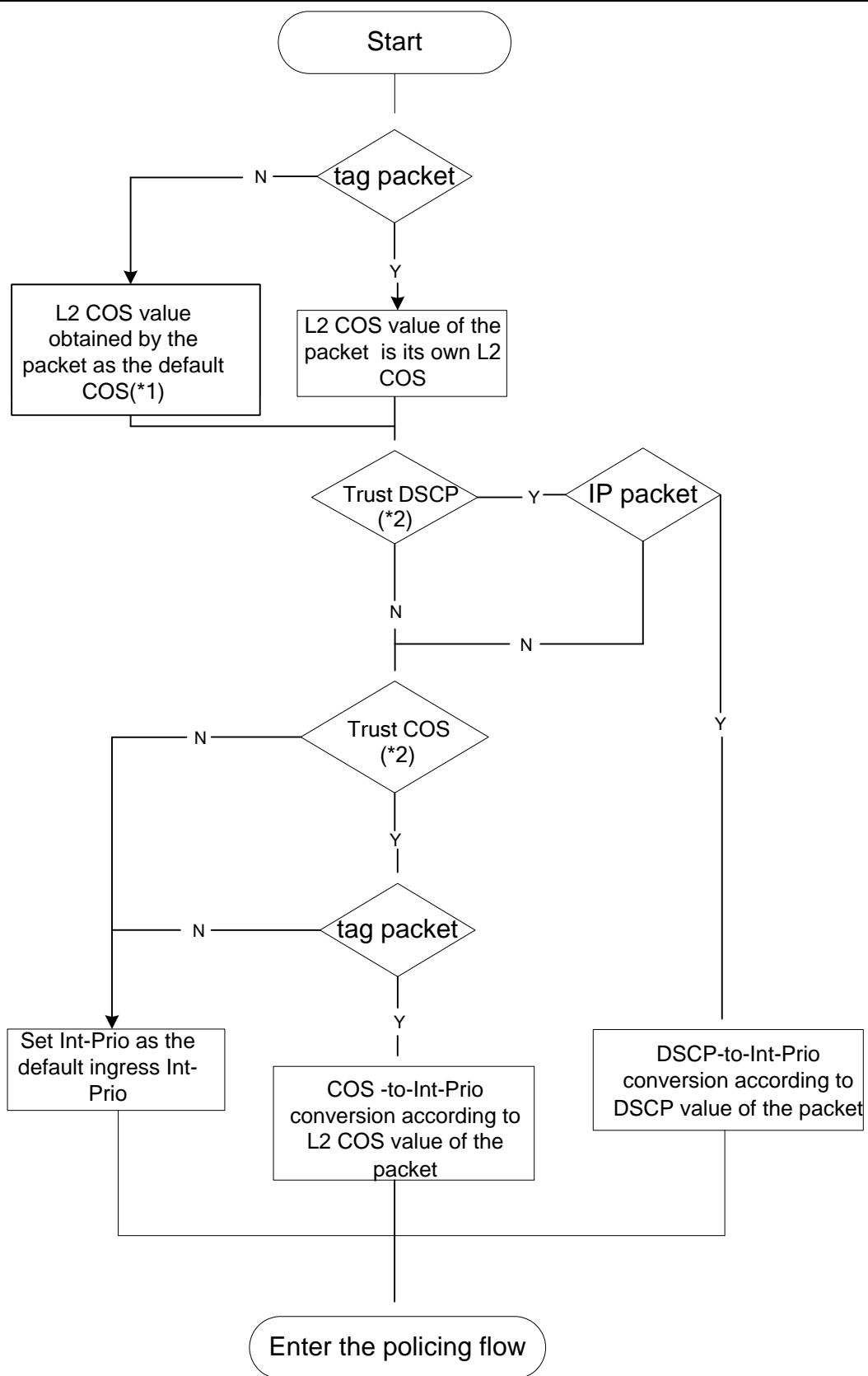

Figure 18-3 Basic QoS Model

**Classification:** Classify traffic according to packet classification information and generate internal DSCP value based on the classification information. For different packet types and switch configurations, classification is performed differently; the flowchart below explains this in detail.



**Figure 18-4** Classification process

Note 1: L2 CoS value is considered a property of the packets, there is no relation with the internal priority obtained of the following flow.

Note 2: Allow Trust DSCP and Trust COS to be configured at the same time, the priority is as follows: DSCP>COS.

**Policing and remark:** Each packet in classified ingress traffic is assigned an internal priority value, and can be policed and remarked.

Policing can be performed based on the flow to configure different policies that allocate bandwidth to classified traffic, the assigned bandwidth policy may be single bucket dual color or dual bucket three color. The traffic, will be assigned with different color, can be discarded or passed, for the passed packets, add the remarking action. Remarking uses a new Int-Prio value of lower priority to replace the original higher level Int-Prio value in the packet. COS and DSCP fields will be modified according to the new Int-Prio at the egress. The following flowchart describes the operations.

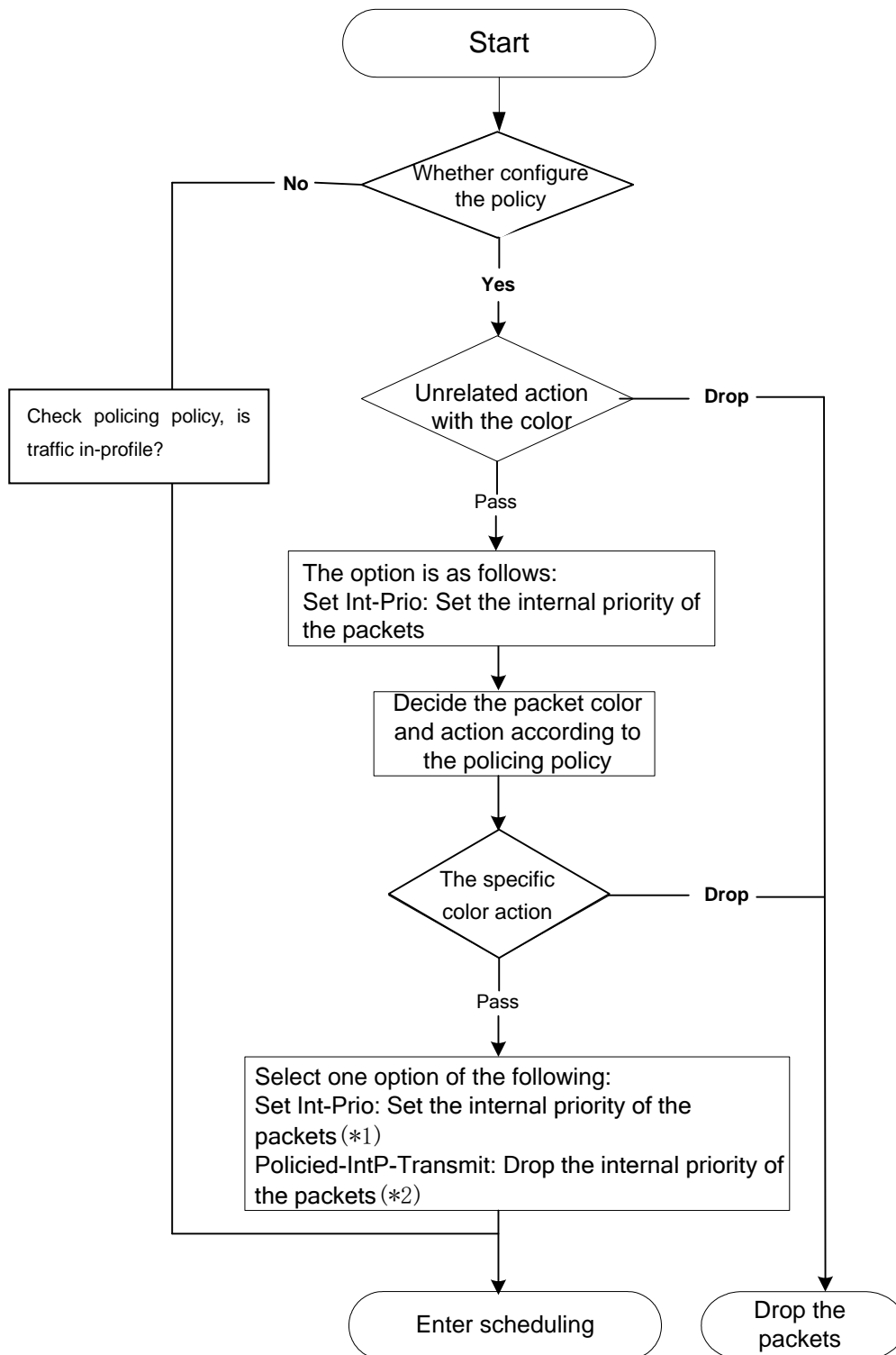
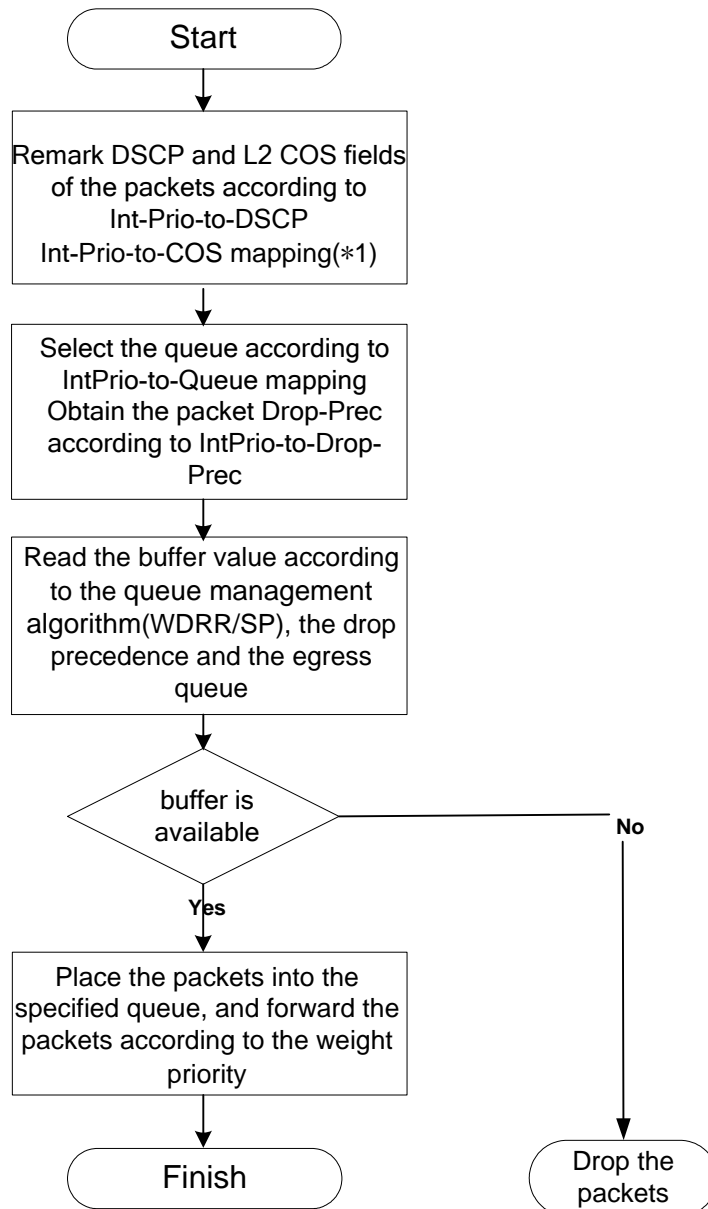

**Figure 18-5** Policing and Remarking process

Note 1: Int-Prio will be covered with the after setting, Set Int-Prio of the specific color action will cover Set Int-Prio of the unrelated action with the color.

Note 2: Drop the internal priority of the packets according to IntP-to-IntP map. Source Int-Prio means to the obtainable Int-Prio in Classification flow or Int-Prio set by the unrelated action with the color.

**Queuing and scheduling:** There are the internal priority for the egress packets, the scheduling operation assigns the packets to different priority queues according to the internal priority, and then forward the packets according to the priority queue weight and the drop precedence. The following flowchart describes the scheduling operation.



**Figure 18-6** Queuing and Scheduling process

Note 1: The ingress configures pass-through-cos, pass-through-dscp to forbid the rewrite of L2 CoS priority and dscp value. At the egress, obtain L2 CoS priority and dscp value according to the final Int-Prio of the packets, decide whether rewrite L2 CoS priority and dscp value according to pass-through-cos, pass-through-dscp.

## 18.2 QoS Configuration Task List

### 1. Configure class map

Set up a classification rule according to ACL, CoS, VLAN ID, IPv4 Precedent, DSCP, IPV6 FL to classify the data stream. Different classes of data streams will be processed with different policies.

### 2. Configure a policy map

After data stream classification, a policy map can be created to associate with the class map created earlier and enter class mode. Then different policies (such as bandwidth limit, priority degrading assigning new DSCP value) can be applied to different data streams. You can also define a policy set that can be use in a policy map by several classes.

### 3. Apply QoS to the ports or the VLAN interfaces

Configure the trust mode for ports or bind policies to ports. A policy will only take effect on a port when it is bound to that port.

The policy may be bound to the specific VLAN.

It is not recommended to synchronously use policy map on VLAN and its port, or else the policy map priority of the port is higher.

### 4. Configure queue management algorithm

Configure queue management algorithm, such as sp, wdr, and so on.

Configure QoS mapping

Configure the mapping from CoS to DP, DSCP to DSCP, IntP or DP, IntP to DSCP.

### 1. Configure class map.

Command	Explanation
Global Mode	
<b>class-map &lt;class-map-name&gt;</b> <b>no class-map &lt;class-map-name&gt;</b>	Create a class map and enter class map mode; the “ <b>no class-map &lt;class-map-name&gt;</b> ” command deletes the specified class map.
<b>match {access-group &lt;acl-index-or-name&gt;   ip dscp &lt;dscp-list&gt;  ip precedence &lt;ip-precedence-list&gt;  ipv6 access-group &lt;acl-index-or-name&gt;   ipv6 dscp &lt;dscp-list&gt;  ipv6 flowlabel &lt;flowlabel-list&gt; vlan &lt;vlan-list&gt; / cos &lt;cos-list&gt;}</b> <b>no match {access-group   ip dscp   ip precedence / ipv6 access-group   ipv6 dscp   ipv6 flowlabel   vlan   cos}</b>	Set matching criterion (classify data stream by ACL, CoS, VLAN ID, IPv4 Precedent, IPv6 FL or DSCP, etc) for the class map; the no command deletes specified matching criterion.

## 2. Configure a policy map

Command	Explanation
Global Mode	
<b>policy-map &lt;policy-map-name&gt;</b> <b>no policy-map &lt;policy-map-name&gt;</b>	Create a policy map and enter policy map mode; the no command deletes the specified policy map.
<b>class &lt;class-map-name&gt; [insert-before &lt;class-map-name&gt;]</b> <b>no class &lt;class-map-name&gt;</b>	After a policy map is created, it can be associated to a class. Different policy or new DSCP value can be applied to different data streams in class mode; the no command deletes the specified class.
<b>set internal priority &lt;new-intp&gt;</b> <b>no set internal priority</b>	Assign a new internal priority for the classified traffic; the no command cancels the new assigned value.
<b>Single bucket mode:</b> <b>policy &lt;bits_per_second&gt;</b> <b>&lt;normal_burst_bytes&gt; ({exceed-action ACTION} )</b> <b>Dual bucket mode:</b> <b>policy &lt;bits_per_second&gt;</b> <b>&lt;normal_burst_bytes&gt; [pir &lt;peak_rate_bps&gt;]</b> <b>  &lt;maximum_burst_bytes&gt; [{exceed-action ACTION   violate-action ACTION }]</b> <b>ACTION definition:</b> <b>drop   transmit   set-internal-priority &lt;intp_value&gt;   policed-intp-transmit</b> <b>no policy</b>	Configure a policy for the classified flow. The non-aggregation policy command supports three colors. Analyze the working mode of the token bucket, whether it is single rate single bucket, single rate dual bucket, dual rate dual bucket, set corresponding action to different color packets. The no command will delete the mode configuration.
<b>policy aggregate &lt;aggregate-policy-name&gt;</b> <b>no policy aggregate</b>	Apply a policy to classified traffic; the no command deletes the specified policy set.
<b>accounting</b> <b>no accounting</b>	Set statistic function for the classified traffic. After enable this function under the policy class map mode, add statistic function to the traffic of the policy class map. In single bucket mode, the messages can only red or green when passing policy. In the print information, there are two colors(green and red) of the packets. In dual bucket mode, there

	are three colors(green, red and yellow) of the packets.
Policy class map configuration mode	
<b>drop</b> <b>no drop</b>  <b>transmit</b> <b>no transmit</b>	Drop or transmit the traffic that match the class, the no command cancels the assigned action.

### 3. Apply QoS to port or VLAN interface

Command	Explanation
Interface Configuration Mode	
<b>mls qos trust {cos   dscp}</b> <b>no mls qos trust {cos   dscp}</b>	Configure port trust; the no command disables the current trust status of the port.
<b>mls qos cos {&lt;default-cos&gt;}</b> <b>no mls qos cos</b>	Configure the default CoS value of the port; the no command restores the default setting.
<b>service-policy input &lt;policy-map-name&gt;</b> <b>no service-policy input &lt;policy-map-name&gt;</b>	Apply a policy map to the specified port; the no command deletes the specified policy map applied to the port. Egress policy map is not supported yet.
Global Mode	
<b>service-policy input &lt;policy-map-name&gt; vlan &lt;vlan-list&gt;</b> <b>no service-policy input &lt;policy-map-name&gt; vlan &lt;vlan-list&gt;</b>	Apply a policy map to the specified VLAN interface; the no command deletes the specified policy map applied to the VLAN interface.

### 4. Configure queue management algorithm and weight

Command	Explanation
Port Configuration Mode	
<b>mls qos queue algorithm {sp   wrr}</b> <b>no mls qos queue algorithm</b>	Set queue management algorithm, the default queue management algorithm is wrr.
Global Mode	
<b>mls qos queue wrr weight &lt;weight0..weight7&gt;</b> <b>no mls qos queue wrr weight</b>	Set wrr queue weight for all ports globally, the default queue weight is 1 1 1 1 1 1 1 1.



## 5. Configure QoS mapping

Command	Explanation
Global Mode	
<b>mls qos map (cos-dp &lt;dp1...dp8&gt;   dscp-dscp            &lt;in-dscp list&gt; to &lt;out-dscp&gt;   dscp-intp            &lt;in-dscp list&gt; to &lt;intp&gt;   dscp-dp &lt;in-dscp list&gt;            to &lt;dp&gt; )</b> <b>no mls qos map (cos-dp   dscp-dscp              dscp-intp   dscp-dp)</b>  <b>mls qos map intp-dscp &lt;dscp1..dscp8&gt;</b> <b>no mls qos map intp-dscp</b>	Set the priority mapping for QoS, the no command restores the default mapping value.

## 6. Clear accounting data of the specific ports or VLANs

Command	Explanation
Admin Mode	
<b>clear mls qos statistics [interface            &lt;interface-name&gt;   vlan &lt;vlan-id&gt;]</b>	Clear accounting data of the specified ports or VLAN Policy Map. If there are no parameters, clear accounting data of all policy map.

## 7. Show configuration of QoS

Command	Explanation
Admin Mode	
<b>show mls qos maps [cos-dp   dscp-dscp              dscp-intp   dscp-dp   intp-dscp]</b>	Display the configuration of QoS mapping.
<b>show class-map [&lt;class-map-name&gt;]</b>	Display the classified map information of QoS.
<b>show policy-map [&lt;policy-map-name&gt;]</b>	Display the policy map information of QoS.
<b>show mls qos {interface [&lt;interface-id&gt;]            [policy   queuing]   vlan &lt;vlan-id&gt;}</b>	Displays QoS configuration information on a port.

---

## 18.3 QoS Example

Example 1:

Enable QoS function, change the queue out weight of port ethernet 1/0/1 to 1:1:2:2:4:4:8:8, set the port in trust CoS mode without changing DSCP value, and set the default CoS value of the port to 5.

The configuration steps are listed below:

```
Switch#config
Switch(config)# mls qos queue weight 1 1 2 2 4 4 8 8
Switch(Config-If-Ethernet 1/0/1)#mls qos trust cos
Switch(Config-If-Ethernet1/0/1)#mls qos cos 5
```

Configuration result:

When QoS enabled in Global Mode, the egress queue bandwidth proportion of each port is 1:1:2:2:4:4:8:8. When packets have CoS value coming in through port ethernet1/0/1, it will be map to the internal priority according to the CoS value, CoS value 0 to 7 correspond to queue out 1, 2, 3, 4, 5, 6, 7, 8 respectively. If the incoming packet has no CoS value, it is default to 5 and will be put in queue6. All passing packets would not have their DSCP values changed.

Example 2:

In port ethernet1/0/2, set the bandwidth for packets from segment 192.168.1.0 to 10 Mb/s, with a burst value of 4 MB, all packets exceed this bandwidth setting will be dropped.

The configuration steps are listed below:

```
Switch#config
Switch(config)#access-list 1 permit 192.168.1.0 0.0.0.255
Switch(config)#class-map c1
Switch(Config-ClassMap-c1)#match access-group 1
Switch(Config-ClassMap-c1)#exit
Switch(config)#policy-map p1
Switch(Config-PolicyMap-p1)#class c1
Switch(Config-PolicyMap-p1-Class-c1)#policy 10000 4000 exceed-action drop
Switch(Config-PolicyMap-p1-Class-c1)#exit
Switch(Config-PolicyMap-p1)#exit
Switch(config)#interface ethernet 1/0/2
Switch(Config-If-Ethernet1/0/2)#service-policy input p1
```

Configuration result:

An ACL name 1 is set to matching segment 192.168.1.0. Enable QoS globally, create a class map named c1, matching ACL1 in class map; create another policy map named p1 and refer to c1 in p1, set appropriate policies to limit bandwidth and burst value. Apply this policy map on port ethernet1/0/2. After the above settings done, bandwidth for packets from segment 192.168.1.0 through port ethernet 1/0/2 is set to 10 Mb/s, with a burst value of 4 MB, all packets exceed this bandwidth setting in that segment will be dropped.

Example 3:

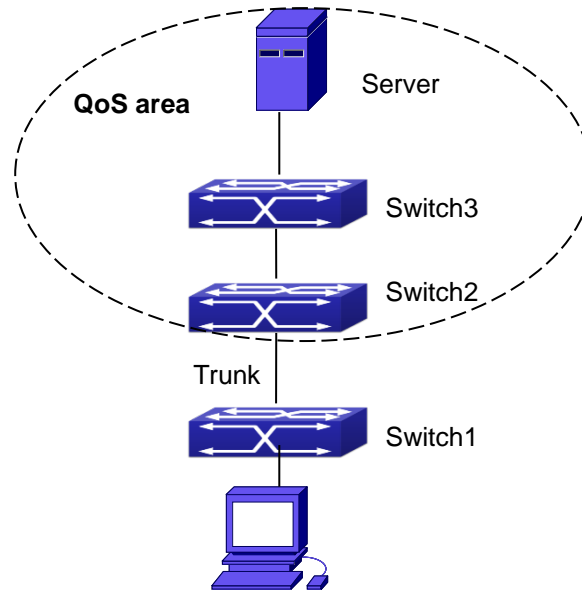

Figure 18-7 Typical QoS topology

As shown in the figure, inside the block is a QoS domain, Switch1 classifies different traffics and assigns different IP precedences. For example, set CoS precedence for packets from segment 192.168.1.0 to 5 on port ethernet1/0/1(set the internal priority to 40, set the default intp-dscp mapping to 40-40, the corresponding IP precedence to 5). The port connecting to switch2 is a trunk port. In Switch2, set port ethernet 1/0/1 that connecting to switch1 to trust dscp. Thus inside the QoS domain, packets of different priorities will go to different queues and get different bandwidth.

The configuration steps are listed below:

**QoS configuration in Switch1:**

```
Switch#config
Switch(config)#access-list 1 permit 192.168.1.0 0.0.0.255
Switch(config)#class-map c1
Switch(Config-ClassMap-c1)#match access-group 1
Switch(Config-ClassMap-c1)#exit
Switch(config)#policy-map p1
Switch(Config-PolicyMap-p1)#class c1
Switch(Config-PolicyMap-p1-Class-c1)#set ip precedence 40
Switch(Config-PolicyMap-p1-Class-c1)#exit
Switch(Config-PolicyMap-p1)#exit
Switch(config)#interface ethernet 1/0/1
Switch(Config-If-Ethernet1/0/1)#service-policy input p1
```

---

### QoS configuration in Switch2:

```
Switch#config
Switch(config)#interface ethernet 1/0/1
Switch(Config-If-Ethernet1/0/1)#mls qos trust cos
```

## 18.4 QoS Troubleshooting

- trust cos and EXP can be used with other trust or Policy Map.
- trust dscp can be used with other trust or Policy Map. This configuration takes effect to IPv4 and IPv6 packets.
- trust exp, trust dscp and trust cos may be configured at the same time, the priority is: EXP>DSCP>COS.
- If the dynamic VLAN (mac vlan/voice vlan/ip subnet vlan/protocol vlan) is configured, then the packet COS value equals COS value of the dynamic VLAN.
- At present, it is not recommended to synchronously use policy map on VLAN and VLAN's port.

---

# Chapter 19 Flow-based Redirection

## 19.1 Introduction to Flow-based Redirection

Flow-based redirection function enables the switch to transmit the data frames meeting some special condition (specified by ACL) to another specified port. The frames meeting a same special condition are called a class of flow, the ingress port of the data frame is called the source port of redirection, and the specified egress port is called the destination port of redirection. Usually there are two kinds of application of flow-based redirection: 1. connecting a protocol analyzer (for example, Sniffer) or a RMON monitor to the destination port of redirection, to monitor and manage the network, and diagnose the problems in the network; 2. Special transmission policy for a special type of data frames.

The switch can only designate a single destination port of redirection for a same class of flow within a source port of redirection, while it can designate different destination ports of redirection for different classes of flows within a source port of redirection. The same class of flow can be applied to different source ports.

## 19.2 Flow-based Redirection Configuration Task Sequence

1. Flow-based redirection configuration
2. Check the current flow-based redirection configuration

### 1. Flow-based redirection configuration

Command	Explanation
Physical Interface Configuration Mode	
<b>access-group &lt;aclname&gt; redirect to interface [ethernet &lt;IFNAME&gt; &lt;IFNAME&gt;] no access-group &lt;aclname&gt; redirect</b>	Specify flow-based redirection for the port; the “ <b>no access-group &lt;aclname&gt; redirect</b> ” command is used to delete flow-based redirection.

### 2. Check the current flow-based redirection configuration

Command	Explanation
Global Mode/Admin Mode	
<b>show flow-based-redirect {interface [ethernet &lt;IFNAME&gt;  &lt;IFNAME&gt;]}</b>	Display the information of current flow-based redirection in the system/port.

---

## 19.3 Flow-based Redirection Examples

### Example:

User's request of configuration is listed as follows: redirecting the frames whose source IP is 192.168.1.111 received from port 1 to port 6, that is sending the frames whose source IP is 192.168.1.111 received from port 1 through port6.

### Modification of configuration:

- 1: Set an ACL, the condition to be matched is: source IP is 192.168.1.111;
- 2: Apply the redirection based on this flow to port 1.

### The following is the configuration procedure:

```
Switch(config)#access-list 1 permit host 192.168.1.111
Switch(config)#interface ethernet 1/0/1
Switch(Config-If-Ethernet1/0/1)# access-group 1 redirect to interface ethernet 1/0/6
```

## 19.4 Flow-based Redirection Troubleshooting Help

When the configuration of flow-based redirection fails, please check that whether it is the following reasons causing the problem:

- The type of flow (ACL) can only be digital standard IP ACL, digital extensive IP ACL, nomenclature standard IP ACL, nomenclature extensive IP ACL, digital standard IPv6 ACL, and nomenclature standard IPv6 ACL;
- Parameters of Timerange and Portrange can not be set in ACL, the type of ACL should be Permit.
- The redirection port must be 1000Mb port in the flow-based redirection function.
- Do not implement the forward across VLAN for flow-based redirection.

---

# Chapter 20 Egress QoS Configuration

## 20.1 Introduction to Egress QoS

In traditional IP networks, all packets are treated in the same way. All network equipments treat them by the first-in-first-out policy and try best effort to send them to the destination. However, it does not guarantee the performance like reliability and transmission delay. Network develops so fast that new demand has been raised for the quality of service on IP network with the continual emergence of new applications. For example, delay-sensitive services like VoIP and video put higher demands on packet transmission delay and users cannot accept too long transmission delay (by contrast, E-mail and FTP services are not sensitive to the time delay). In order to support services with different service requirement like voice, video and data service, the network is required to be able to distinguish between different communications and provide appropriate service. The traditional best-effort IP network cannot identify and distinguish various kinds of communications while this ability is the very premise of providing differentiated services for different communications. Therefore, the best-effort service mode of traditional network cannot meet the demand of applications. The emergence of QoS techniques is committed to solve this problem.

Egress PolicyMap is the QoS policy in egress which performs QoS control of packets in the egress direction and provides better service for specified network communication with kinds of techniques. Egress PolicyMap includes class-map and policy-map, of which class-map is used for selecting packets to operate and policy-map is used for specifying the operation to use. Not all equipments support Egress QoS currently.

### 20.1.1 Egress QoS Terms

**Egress QoS:** Achieving QoS on egress of port.

**Inner\_vid:** VLAN ID brought by the TAG near the header of network layer when double TAGs exist.

**Outer\_vid:** VLAN ID brought by the TAG near the header of network link layer when double TAGs exist. The TAG is considered to be outer tag by default when only one TAG exists.

**Outer\_tpid:** Protocol type of the network link layer header indicating the type of outer tag.

## 20.1.2 Basic Egress QoS Model

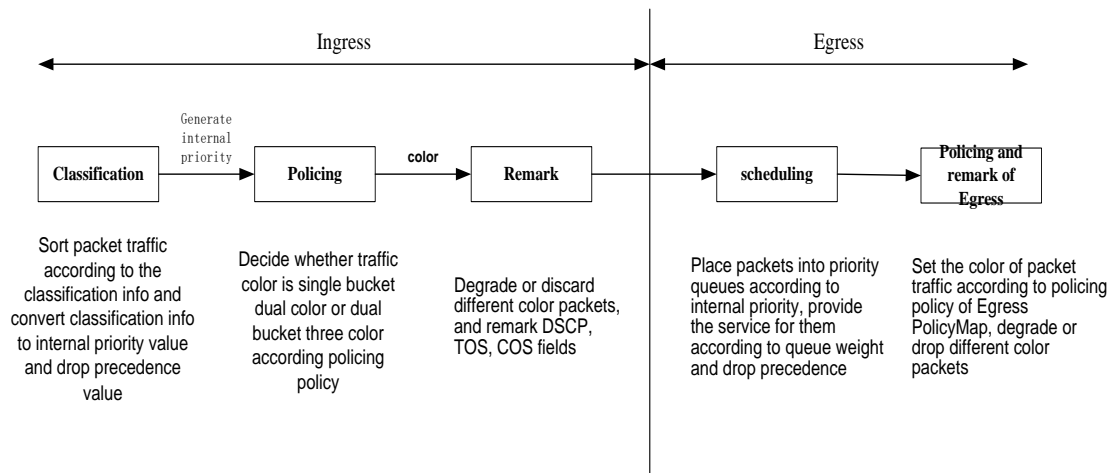

According to the characters (including field values like COS and DSCP) of upstream packets, policing and rewriting of Egress make the last QoS change on the packet prior to the packet egress.

Policing configures different policing policy based on the flow and distributes bandwidth for the flow classified. The distribution policy of bandwidth can be either dual bucket dual color or dual bucket three color. Different colors can be assigned to different flows and approaches of discard or passage can be chosen for them; you can add rewriting action for packets with passage approach chosen. See the following flow chart for detailed description of Egress QoS:

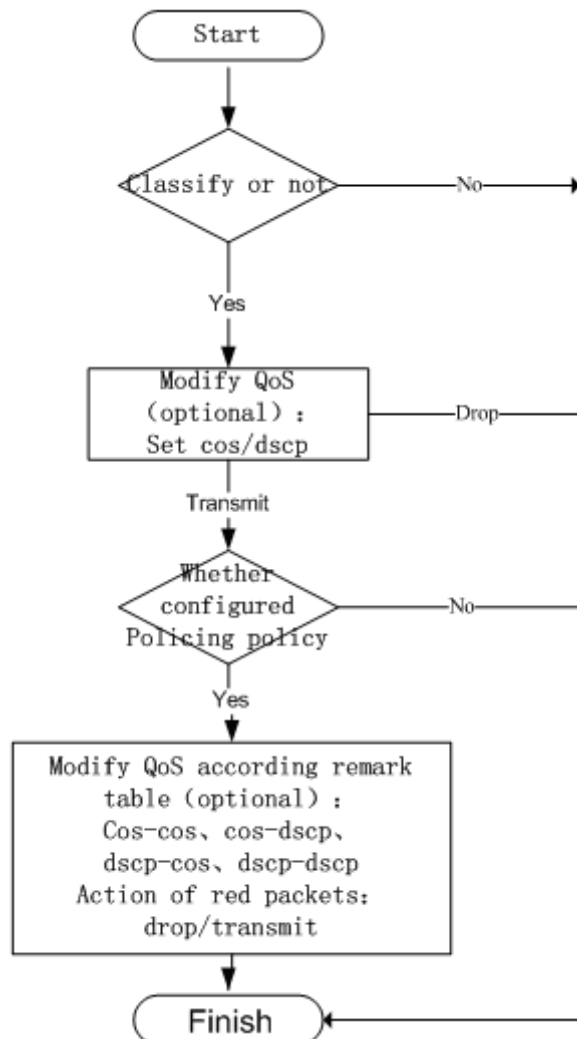



Description of action that modify QoS attribute according to egress remark table:

**cos-cos** : for cos value of packets, modify cos value of packets according to cos table of QoS remarking

**cos-dscp** : for cos value of packets, modify dscp value of packets according to cos table of QoS remarking

**dscp-cos** : for dscp value of packets, modify cos value of packets according to dscp table of QoS remarking

**dscp-dscp** : for dscp value of packets, modify dscp value of packets according to dscp table of QoS remarking

## 20.2 Egress QoS Configuration

Egress QoS Configuration Task List:

### 1. Configure class map

Set up a classification rule according to ACL, CoS, VLAN ID, IPv4 Precedent, DSCP, IPV6 DSCP to classify the data stream. Different classes of data streams will be processed with different policies.

### 2. Configure policy map

After data steam classification, a policy map can be created to associate with a class map created earlier and enter policy class mode. Then different policies (such as bandwidth limit, assigning new DSCP value) can be applied to different data streams.

### 3. Apply Egress QoS to port or VLAN

Configure the trust mode or binding policies for ports. A policy will only take effect on a port when it is bound to that port.

The policy may be bound to the specific VLAN.

Set Egress QoS remark mapping

If modify QoS attribute by using Egress QoS remark in policy, it should set the corresponding mapping. If it needs to take effect to green packets, modifying switch of green packets should be enabled and ingress needs to trust the corresponding QoS attribute (qos/dscp/exp).

### 1. Configure a class-map

Command	Explanation
Global Mode	
<b>class-map &lt;class-map-name&gt;</b> <b>no class-map &lt;class-map-name&gt;</b>	Create a class-map and enter class-map mode, no command deletes the specified class-map.
<b>match {access-group &lt;acl-index-or-name&gt;   ip dscp &lt;dscp-list&gt;   ip precedence &lt;ip-precedence-list&gt;   ipv6 dscp &lt;dscp-list&gt;   vlan &lt;vlan-list&gt;   cos &lt;cos-list&gt;   ipv6 access-group &lt;acl-index-or-name&gt;}</b> <b>no match {access-group   ip dscp   ip precedence   ipv6 dscp   vlan   cos   ipv6 access-group}</b>	Configure the matched standard of the class map to classify the data stream according to ACL, CoS, VLAN ID, IPv4 Precedence, DSCP, IPV6 DSCP priority; no command deletes the specific matched standard.

## 2. Configure a policy-map

Command	Explanation
Global Mode	
<b>policy-map</b> <policy-map-name> <b>no policy-map</b> <policy-map-name>	Create a policy-map and enter policy-map mode, no command deletes the specific policy-map.
<b>class</b> <class-map-name> [insert-before <class-map-name>] <b>no class</b> <class-map-name>	Create a policy map to associate with a class map and enter policy class map mode, then different data streams can apply different policies and be assigned a new DSCP value. No command deletes the specified policy class map.
<b>set</b> {ip dscp <new-dscp>   ip precedence <new-precedence>   cos <new-cos>   c-vid <new-c-vid>   s-vid <new-s-vid>   s-tpid <new-s-tpid>} <b>no set</b> {ip dscp   ip precedence   cos   c-vid   s-vid   s-tpid}	Assign a new DSCP, CoS and IP Precedence value for the classified flow, no command cancels the operation.
<b>Single bucket mode:</b> <b>policy</b> <bits_per_second> <normal_burst_bytes> ({action ACTION}   exceed-action drop   transmit})  <b>Dual bucket mode:</b> <b>policy</b> <bits_per_second> <normal_burst_bytes> [pir <peak_rate_bps>]   <maximum_burst_bytes> [{action ACTION   violate-action drop   transmit}]  <b>ACTION definition:</b> policed-cos-to-cos-transmit   policed-cos-to-dscp-transmit   policed-dscp-exp-to-cos-transmit   policed-dscp-exp-to-dscp-transmit <b>no policy</b>	Configure a policy for the classified flow. The non-aggregation policy command supports three colors. Analyze the working mode of the token bucket, whether it is single rate single bucket, single rate dual bucket or dual rate dual bucket, set corresponding action to different color packets. The no command will delete the configuration. Only specific switch supports single bucket mode.
<b>accounting</b> <b>no accounting</b>	Set statistic function for the classified flow. After enable this function under the policy class map mode, add statistic function to the flow of the policy class map. In single

	<p>bucket mode, packets can only red or green when passing policy. In the print information, in-profile means green and out-profile means red. In dual bucket mode, there are three colors of packets in-profile means green and out-profile means red and yellow.</p>
--	--

### 3. Apply policy to port or VLAN

Command	Explanation
Interface Mode	
<b>service-policy output &lt;policy-map-name&gt;</b> <b>no service-policy output&lt;policy-map-name&gt;</b>	Apply a policy map to the egress of the port; the no command deletes the specified policy map applied to the port.
Global Mode	
<b>service-policy output &lt;policy-map-name&gt; vlan &lt;vlan-list&gt;</b> <b>no service-policy output &lt;policy-map-name&gt; vlan &lt;vlan-list&gt;</b>	Apply a policy map to the egress of the VLAN; the no command deletes the specified policy map applied to the VLAN interface.

### 4. Set Egress QoS remark mapping

Command	Explanation
Global Mode	
<b>mls qos map {cos-cos   cos-dscp} {green   yellow   red} &lt;value1&gt; &lt;value2&gt;...&lt;value8&gt;</b> <b>no mls qos map {cos-cos   cos-dscp} {green   yellow   red}</b>	Set Egress cos mapping, no command restores the default configuration.
<b>mls qos map {dscp-cos   dscp-dscp} {green   yellow   red} &lt;dscp list&gt; to &lt;value&gt;</b> <b>no mls qos map {dscp-cos   dscp-dscp} {green   yellow   red}</b>	Set Egress dscp mapping, <dscp-list> means 1 to 8 dscp values, no command restores the default configuration.
<b>mls qos egress green remark</b> <b>no mls qos egress green remark</b>	Set Egress QoS remark mapping to take effect for green packets, no command does not take effect to green packets.

## 5. Clear accounting data of the specific ports or VLANs

Command	Explanation
Admin Mode	
<b>clear mls qos statistics [interface &lt;interface-name&gt;   vlan &lt;vlan-id&gt;]</b>	Clear accounting data of the specified ports or VLAN Policy Map. If there are no parameters, clear accounting data of all policy map.

## 6. Show QoS configuration

Command	Explanation
Admin Mode	
<b>show mls qos {interface [&lt;interface-id&gt;] [policy   queuing]   vlan &lt;vlan-id&gt;}</b>	Show QoS configuration of the port.
<b>show class-map [&lt;class-map-name&gt;]</b>	Show the class map information of QoS.
<b>show policy-map [&lt;policy-map-name&gt;]</b>	Show the policy map information of QoS.
<b>show mls qos maps {cos-cos   cos-dscp   dscp-cos   dscp-exp} {green   yellow   red  }</b>	Show mapping relation of Egress QoS remark.

## 20.3 Egress QoS Examples

Example1:

On the egress of the port1, change cos value as 4 for the packet with dscp value of 0.

Create a class map:

```
switch(config)#class-map 1
switch(config-classmap-1)#match ip dscp 0
switch(config-classmap-1)#exit
```

Create a policy map:

```
switch(config)#policy-map 1
switch(config-policymap-1)#class 1
switch(config-policymap-1-class-1)#set cos 4
switch(config-policymap-1-class-1)#exit
switch(config-policymap-1)#exit
```

Bind a policy to the port:

```
switch(config)#in e 1/0/1
switch(config-if-ethernet1/0/1)#service-policy output 1
```

---

Example2:

On the egress of vlan10, change cos value as 4 for the packet with ipv6 dscp value of 7.

Create a class map:

```
switch(config)#class-map 1
switch(config-classmap-1)#match ipv6 dscp 7
switch(config-classmap-1)#exit
```

Create a policy map:

```
switch(config)#policy-map 1
switch(config-policymap-1)#class 1
switch(config-policymap-1-class-1)#set cos 4
switch(config-policymap-1-class-1)#exit
switch(config-policymap-1)#exit
```

Bind a policy to VLAN

```
switch(config)#service-policy output 1 vlan 10
```

Example 3:

In egress of port 1, limit the speed of packets. Set the bandwidth for packets to 1 Mb/s, with the normal burst value of 1 MB, the max burst value of 4 MB, set dscp value of 1 as 10 for green packets, set dscp value of yellow packets as 9 and drop red packets.

Create a class map:

```
switch(config)#class-map c1
switch(config-classmap-c1)#match ip dscp 1
switch(config-classmap-c1)#exit
```

Create a policy map:

```
switch(config)#policy-map p1
switch(config-policymap-p1)#class c1
switch(config-policymap-p1-class-c1)#policy 1000 1000 4000 action policed-dscp-exp-to-dscp-transmit
violate-action drop
switch(config-policymap-p1-class-c1)#exit
switch(config-policymap-p1)#exit
```

Set Egress dscp remark mapping

```
switch(config)#mls qos map dscp-dscp green 1 to 10
switch(config)#mls qos map dscp-dscp yellow 1 to 9
```

---

Set Egress remark to take effect for green packets

```
switch(config)#mls qos egress green remark
```

Set trust dscp mode on ingress

```
switch(config-if-port-range)#mls qos trust dscp
```

Bind policy to egress of port1

```
switch(config-if-ethernet1/0/1)#service-policy output p1
```

## 20.4 Egress QoS Examples

- Not all equipments support Egress QoS presently, so please make sure the current device supports this function.
- If the policy configured cannot bind to the port or VLAN, please check whether the match option in classification table is supported by the current device.
- If terminal printing suggests lack of resource, please make sure there is enough resource to send the current policy.
- If the policy with match acl configured cannot bind to the port or VLAN, please make sure rules including permit exist in ACL.
- If modifying QoS attribute is invalid by Egress QoS remark, please ensure whether ingress sets the corresponding QoS attribute with trust.
- If egress set QoS attributes (set cos/ip dscp) for modifying all packets, and it uses Egress remark to modify QoS attributes for packets of different colors, previous modification is preferential for modifying packets.

---

# Chapter 21 Flexible Q-in-Q Configuration

## 21.1 Introduction to Flexible Q-in-Q

### 21.1.1 Q-in-Q Technique

Dot1q-tunnel is also called Q-in-Q (802.1Q-in-802.1Q), which is an expansion of 802.1Q. Its dominating idea is encapsulating the customer VLAN tag (CVLAN tag) to the service provider VLAN tag (SPVLAN tag). The packet with two VLAN tags is transmitted through the backbone network of the ISP internet to provide a simple layer-2 tunnel for the users. It is simple and easy to manage, applicable only by static configuration, and especially adaptive to small office network or small metropolitan area network using layer-3 switch as backbone equipment.

There are two kinds of Q-in-Q: basic Q-in-Q and flexible Q-in-Q, the priority of flexible Q-in-Q is higher than basic Q-in-Q.

### 21.1.2 Basic Q-in-Q

Basic Q-in-Q based the port. After a port configures Q-in-Q, whether the received packet with tag or not, the device still packs the default VLAN tag for the packet. Using basic Q-in-Q is simple, but the setting method of VLAN tag is inflexible.

### 21.1.3 Flexible Q-in-Q

Flexible Q-in-Q based data flow. It selects whether pack the external tag and packs what kind of the external tag by matching the material flow. For example: implement the property of flexible Q-in-Q according to the user's VLAN tag, MAC address, IPv4/IPv6 address, IPv4/IPv6 protocol and the port ID of the application, etc. So, it can encapsulate the external tag for the packet and implements different scheme by different users or methods.

## 21.2 Flexible Q-in-Q Configuration Task List

The match of flexible Q-in-Q data flow uses policy-map rule of QoS to be sent, the configuration task list is as follows:

1. Create class-map to classify different data flows
2. Create flexible Q-in-Q policy-map to relate with the class-map and set the corresponding operation
3. Bind flexible Q-in-Q policy-map to port

## 1. Configure class map

Command	Explanation
Global mode	
<b>class-map &lt;class-map-name&gt;</b> <b>no class-map &lt;class-map-name&gt;</b>	Create a class-map and enter class-map mode, the no command deletes the specified class-map.
<b>match {access-group &lt;acl-index-or-name&gt;</b> <b>  ip dscp &lt;dscp-list&gt;  ip precedence</b> <b>&lt;ip-precedence-list&gt;  ipv6 access-group</b> <b>&lt;acl-index-or-name&gt;  ipv6 dscp &lt;dscp-list&gt;</b> <b>  ipv6 flowlabel &lt;flowlabel-list&gt;   vlan</b> <b>&lt;vlan-list&gt;   cos &lt;cos-list&gt;}</b> <b>no match {access-group   ip dscp   ip</b> <b>precedence ipv6 access-group  ipv6 dscp  </b> <b>ipv6 flowlabel   vlan   cos}</b>	Set the match standard of class-map, (classify data flow by ACL, CoS, VLAN ID, IPv4 Precedent or DSCP, etc for the class map); the no command deletes the specified match standard.

## 2. Configure policy-map of flexible Q-in-Q

Command	Explanation
Global mode	
<b>policy-map &lt;policy-map-name&gt;</b> <b>no policy-map &lt;policy-map-name&gt;</b>	Create a policy-map and enter policy-map mode, the no command deletes the specified policy-map.
<b>class &lt;class-map-name&gt; [insert-before</b> <b>&lt;class-map-name&gt;]</b> <b>no class &lt;class-map-name&gt;</b>	After a policy-map is created, it can be associated to a class. Different policy or new DSCP value can be applied to different data flows in class mode; the no command deletes the specified class-map.
<b>set s-vid &lt;vid&gt;</b> <b>no set s-vid</b>	Set external VLAN Tag for the classified traffic, no command cancels the operation.
<b>add s-vid &lt;vid&gt;</b> <b>no add s-vid &lt;vid&gt;</b>	Add external VLAN Tag for the classified traffic, no command cancels the operation.



### 3. Bind flexible Q-in-Q policy-map to port

Command	Explanation
Port mode	
<b>service-policy input&lt;policy-map-name&gt;</b> <b>no service-policy input&lt;policy-map-name&gt;</b>	Apply a policy-map to a port, the no command deletes the specified policy-map applied to the port.
Global mode	
<b>service-policy input&lt;policy-map-name&gt;</b> <b>vlan&lt;vid&gt;</b> <b>no service-policy input&lt;policy-map-name&gt;</b> <b>vlan &lt;vid&gt;</b>	Apply a policy-map to a VLAN, the no command deletes the specified policy-map applied to the VLAN.

### 4. Show flexible Q-in-Q policy-map bound to port

Command	Explanation
Admin mode	
<b>show mls qos {interface [&lt;interface-id&gt;]}</b>	Show flexible QinQ configuration on the port.

## 21.3 Flexible Q-in-Q Example

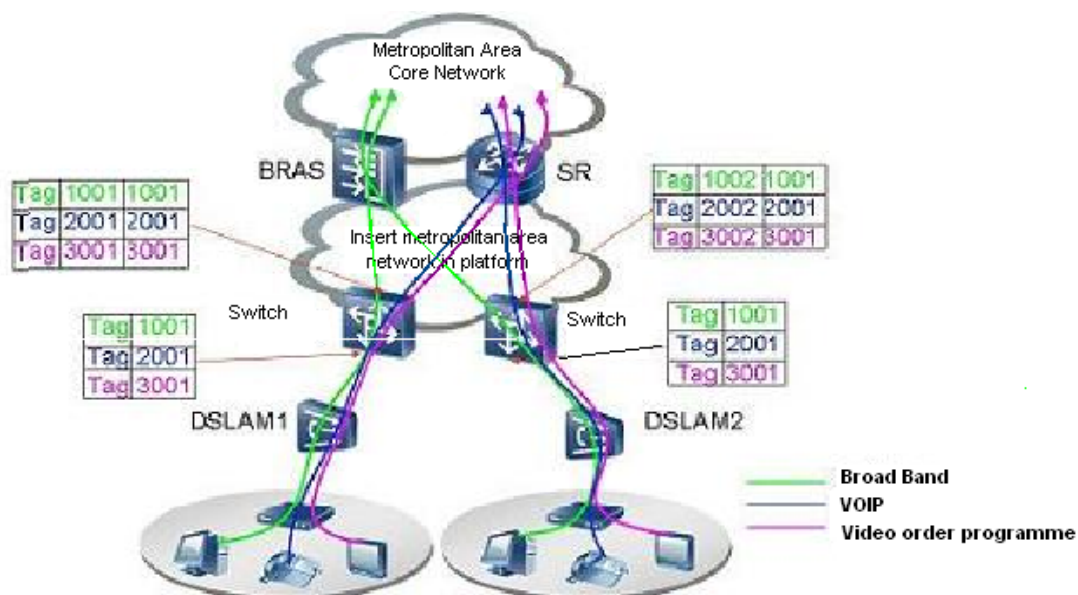

Figure 21-1 Flexible Q-in-Q application topology

As shown in the figure, the first user is assigned three VLANs that the tag values are 1001, 2001, 3001 respectively in DSLAM1. VLAN1001 corresponds to Broad Band Network, VLAN2001 corresponds to VOIP, VLAN3001 corresponds to VOD. After the downlink port enables flexible QinQ function, the packets will be packed with different external tags according to VLAN ID of users.

---

The packet with tag 1001 will be packed an external tag 1001 directly(This tag is unique in public network), enter Broad Band Network-VLAN1001 and classified to BRAS device. The packet with tag 2001(or 3001) will be packed an external tag 2001(or 3001) and classified to SR device according to the flow rules. The second user can be assigned different VLAN tags for different VLANs in DSLAM2. Notice: The assigned VLAN tag of the second user may be same with the first user and the packet with tag will be also packed an external tag. In the above figure, the external tag of the second user is different to the first user for distinguishing DSLAM location and locating the user finally.

The configuration in the following:

If the data flow of DSLAM1 enters the switch's downlink port1, the configuration is as follows:

```
Switch(config)#class-map c1
Switch(config-classmap-c1)#match vlan 1001
Switch(config-classmap-c1)#exit
Switch(config)#class-map c2
Switch(config-classmap-c2)#match vlan 2001
Switch(config-classmap-c2)#exit
Switch(config)#class-map c3
Switch(config-classmap-c3)#match vlan 3001
Switch(config-classmap-c3)#exit
Switch(config)#policy-map p1
Switch(config-policymap-p1)#class c1
Switch(config-policymap-p1-class-c1)# set s-vid 1001
Switch(config-policymap-p1)#class c2
Switch(config-policymap-p1-class-c2)# set s-vid 2001
Switch(config-policymap-p1)#class c3
Switch(config-policymap-p1-class-c3)# set s-vid 3001
Switch(config-policymap-p1-class-c3)#exit
Switch(config-policymap-p1)#exit
Switch(config)#interface ethernet 1/0/1
Switch(config-if-ethernet1/0/1)#service-policy input p1
```

---

If the data flow of DSLAM2 enters the switch's downlink port1, the configuration is as follows:

```
Switch(config)#class-map c1
Switch(config-classmap-c1)#match vlan 1001
Switch(config-classmap-c1)#exit
Switch(config)#class-map c2
Switch(config-classmap-c2)#match vlan 2001
Switch(config-classmap-c2)#exit
Switch(config)#class-map c3
Switch(config-classmap-c3)#match vlan 3001
Switch(config-classmap-c3)#exit
Switch(config)#policy-map p1
Switch(config-policymap-p1)#class c1
Switch(config-policymap-p1-class-c1)# set s-vid 1002
Switch(config-policymap-p1)#class c2
Switch(config-policymap-p1-class-c2)# set s-vid 2002
Switch(config-policymap-p1)#class c3
Switch(config-policymap-p1-class-c3)# set s-vid 3002
Switch(config-policymap-p1-class-c3)#exit
Switch(config-policymap-p1)#exit
Switch(config)#interface ethernet 1/0/1
Switch(config-if-ethernet1/0/1)# service-policy input p1
```

## 21.4 Flexible Q-in-Q Troubleshooting

If flexible Q-in-Q policy can not be bound to the port, please check whether the problem is caused by the following reasons:

- Make sure flexible Q-in-Q whether supports the configured class-map and policy-map
- Make sure ACL includes permit rule if the class-map matches ACL rule
- Make sure the switch exists enough TCAM resource to send the binding
- Priority of flexible Q-in-Q and vlan ingress filtering for processing packets is: flexible Q-in-Q > vlan ingress filtering

---

# Chapter 22 Layer 3 Forward Configuration

Switch supports Layer 3 forwarding which forwards Layer 3 protocol packets (IP packets) across VLANs. Such forwarding uses IP addresses, when a interface receives an IP packet, it will perform a lookup in its own routing table and decide the operation according to the lookup result. If the IP packet is destined to another subnet reachable from this switch, then the packet will be forwarded to the appropriate interface. Switch can forward IP packets by hardware, the forwarding chip of switch have a host route table and default route table. Host route table stores host routes to connect to the switch directly; default route table stores network routes (after aggregation algorithm process).

If the route (either host route or network route) for forwarding unicast traffic exists in the forwarding chip, the forwarding of traffic will be completely handled by hardware. As a result, forwarding efficiency can be greatly improved, even to wire speed.

## 22.1 Layer 3 Interface

### 22.1.1 Introduction to Layer 3 Interface

Layer 3 interface can be created on switch. The Layer 3 interface is not a physical interface but a virtual interface. Layer 3 interface is built on VLANs. The Layer 3 interface can contain one or more layer 2 ports which belong to the same VLAN, or contain no layer 2 ports. At least one of the Layer 2 ports contained in Layer 3 interface should be in UP state for Layer 3 interface in UP state, otherwise, Layer 3 interface will be in DOWN state. All layer 3 interfaces in the switch use the same MAC address by default, this address is selected from the reserved MAC address while creating Layer 3 interface. The Layer 3 interface is the base for layer 3 protocols. The switch can use the IP addresses set in the layer 3 interfaces to communicate with the other devices via IP. The switch can forward IP packets between different Layer 3 interfaces. Loopback interface belongs to Layer 3 interface.

### 22.1.2 Layer 3 Interface Configuration Task List

Layer 3 Interface Configuration Task List:

1. Create Layer 3 interface
2. Bandwidth for Layer 3 Interface configuration
3. Configure VLAN interface description
4. Open or close the VLAN interface
5. VRF configuration
  - (1) Create VRF instance and enter VPN view
  - (2) Configure RD of VRF instance (optional)
  - (3) Configure RT of VRF instance (optional)
  - (4) Configure the relation between VRF instance and the interface

---

## 1. Create Layer 3 Interface

Command	Explanation
Global Mode	
<b>interface vlan &lt;vlan-id&gt;</b> <b>no interface vlan &lt;vlan-id&gt;</b>	Creates a VLAN interface (VLAN interface is a Layer 3 interface); the no command deletes the VLAN interface (Layer 3 interface) created in the switch.
<b>interface loopback &lt;loopback-id&gt;</b> <b>no interface loopback &lt;loopback-id&gt;</b>	Creates a Loopback interface then enter the loopback Port Mode; the no command deletes the Loopback interface created in the switch.

## 2. Bandwidth for Layer 3 Interface configuration

Command	Explanation
VLAN Interface Mode	
<b>bandwidth &lt;bandwidth&gt;</b> <b>no bandwidth</b>	Configure the bandwidth for Layer 3 Interface. The no command recovery the default value.

## 3. Configure VLAN interface description

Command	Explanation
VLAN Interface Mode	
<b>description &lt;text&gt;</b> <b>no description</b>	Configure the description information of VLAN interface. The no command will cancel the description information of VLAN interface.

## 4. Open or close the vlan interface

Command	Explanation
VLAN Interface Mode	
<b>shutdown</b> <b>no shutdown</b>	Open or close the vlan interface.

## 5. VRF configuration

- (1) Create VRF instance and enter VPN view
- (2) Configure RD of VRF instance (optional)
- (3) Configure RT of VRF instance (optional)
- (4) Configure the relation between VRF instance and the interface

Command	Explanation
Global Mode	
<b>ip vrf &lt;vrf-name&gt;</b> <b>no ip vrf &lt;vrf-name&gt;</b>	Create VRF instance; VRF instance is not created by default.
VRF Mode	
<b>rd &lt;ASN:nn_or_IP-address:nn&gt;</b>	Configure RD of VRF instance. RD is not created by default.
<b>route-target {import   export   both} &lt;rt-value&gt;</b> <b>no route-target {import   export   both} &lt;rt-value&gt;</b>	Configure RT of VRF instance
Interface Mode	
<b>ip vrf forwarding &lt;vrf-name&gt;</b> <b>no ip vrf forwarding &lt;vrf-name&gt;</b>	Configure the relation between VRF instance and the interface.
<b>ip address &lt;ip-address&gt; &lt;mask&gt;</b> <b>no ip address &lt;ip-address&gt; &lt;mask&gt;</b>	Configure the private IP address of direct link interface.

## 22.2 IP Configuration

### 22.2.1 Introduction to IPv4, IPv6

IPv4 is the current version of global universal Internet protocol. The practice has proved that IPv4 is simple, flexible, open, stable, strong and easy to implement while collaborating well with various protocols of upper and lower layers. Although IPv4 almost has not been changed since it was established in 1980's, it has kept growing to the current global scale with the promotion of Internet. However, as Internet infrastructure and Internet application services continue boosting, IPv4 has shown its deficiency when facing the present scale and complexity of Internet.

IPv6 refers to the sixth version of Internet protocol which is the next generation Internet protocol designed by IETF to replace the current Internet protocol version 4 (IPv4). IPv6 was specially developed to make up the shortages of IPv4 addresses so that Internet can develop further.

---

The most important problem IPv6 has solved is to add the amount of IP addresses. IPv4 addresses have nearly run out, whereas the amount of Internet users has been increasing in geometric series. With the greatly and continuously boosting of Internet services and application devices (Home and Small Office Network, IP phone and Wireless Service Information Terminal which make use of Internet,) which require IP addresses, the supply of IP addresses turns out to be more and more tense. People have been working on the problem of shortage of IPv4 addresses for a long time by introducing various technologies to prolong the lifespan of existing IPv4 infrastructure, including Network Address Translation(NAT for short), and Classless Inter-Domain Routing(CIDR for short), etc.

Although the combination of CIDR, NAT and private addressing has temporarily mitigated the problem of IPv4 address space shortage, NAT technology has disrupted the end-to-end model which is the original intention of IP design by making it necessary for router devices that serve as network intermediate nodes to maintain every connection status which increases network delay greatly and decreases network performance. Moreover, the translation of network data packet addresses baffles the end-to-end network security check, IPSec authentication header is such an example.

Therefore, in order to solve all kinds of problems existing in IPv4 comprehensively, the next generation Internet Protocol IPv6 designed by IETF has become the only feasible solution at present.

First of all, the 128 bits addressing scheme of IPv6 Protocol can guarantee to provide enough globally unique IP addresses for global IP network nodes in the range of time and space. Moreover, besides increasing address space, IPv6 also enhanced many other essential designs of IPv4.

Hierarchical addressing scheme facilitates Route Aggregation, effectively reduces route table entries and enhances the efficiency and expansibility of routing and data packet processing.

The header design of IPv6 is more efficient compared with IPv4. It has less data fields and takes out header checksum, thus expedites the processing speed of basic IPv6 header. In IPv6 header, fragment field can be shown as an optional extended field, so that data packets fragmentation process won't be done in router forwarding process, and Path MTU Discovery Mechanism collaborates with data packet source which enhances the processing efficiency of router.

Address automatic configuration and plug-and-play is supported. Large amounts of hosts can find network routers easily by address automatic configuration function of IPv6 while obtaining a globally unique IPv6 address automatically as well which makes the devices using IPv6 Internet plug-and-play. Automatic address configuration function also makes the readdressing of existing network easier and more convenient, and it is more convenient for network operators to manage the transformation from one provider to another.

Support IPSec. IPSec is optional in IPv4, but required in IPv6 Protocol. IPv6 provides security extended header, which provides end-to-end security services such as access control, confidentiality and data integrity, consequently making the implement of encryption, validation and Virtual Private Network easier.

Enhance the support for Mobile IP and mobile calculating devices. The Mobile IP Protocol defined in IETF standard makes mobile devices movable without cutting the existing connection, which is a network function getting more and more important. Unlike IPv4, the mobility of IPv6 is from embedded automatic configuration to get transmission address (Care-Of-Address); therefore it doesn't need Foreign Agent. Furthermore, this kind of binding process enables Correspondent Node communicate with Mobile Node directly, thereby avoids the extra system cost caused by triangle routing choice required in IPv4.

Avoid the use of Network Address Translation. The purpose of the introduction of NAT mechanism is to share and reuse same address space among different network segments. This mechanism mitigates the problem of the shortage of IPv4 address temporarily; meanwhile it adds the burden of address translation process for network device and application. Since the address space of IPv6 has increased greatly, address translation becomes unnecessary, thus the problems and system cost caused by NAT deployment are solved naturally. Support extensively deployed Routing Protocol. IPv6 has kept and extended the supports for existing Internal Gateway Protocols (IGP for short), and Exterior Gateway Protocols (EGP for short). For example, IPv6 Routing Protocol such as RIPng, OSPFv3, IS-ISv6 and MBGP4+, etc.

Multicast addresses increased and the support for multicast has enhanced. By dealing with IPv4 broadcast functions such as Router Discovery and Router Query, IPv6 multicast has completely replaced IPv4 broadcast in the sense of function. Multicast not only saves network bandwidth, but enhances network efficiency as well.

## 22.2.2 IP Configuration

Layer 3 interface can be configured as IPv4 interface, IPv6 interface.

### 22.2.2.1 IPv4 Address Configuration

IPv4 address configuration task list:

1. Configure the IPv4 address of three-layer interface

#### 1. Configure the IPv4 address of three-layer interface

Command	Explanation
VLAN Interface Configuration Mode	
<b>ip address &lt;ip-address&gt; &lt;mask&gt;</b> [secondary] <b>no ip address [&lt;ip-address&gt; &lt;mask&gt;]</b>	Configure IP address of VLAN interface; the <b>no ip address [&lt;ip-address&gt; &lt;mask&gt;]</b> command cancels IP address of VLAN interface.

### 22.2.2.2 IPv6 Address Configuration

The configuration Task List of IPv6 is as follows:

1. IPv6 basic configuration
  - (1) Configure interface IPv6 address
  - (2) Configure IPv6 static routing
2. IPv6 Neighbor Discovery Configuration
  - (1) Configure DAD neighbor solicitation message number
  - (2) Configure send neighbor solicitation message interval



- 
- (3) Enable and disable router advertisement
  - (4) Configure router lifespan
  - (5) Configure router advertisement minimum interval
  - (6) Configure router advertisement maximum interval
  - (7) Configure prefix advertisement parameters
  - (8) Configure static IPv6 neighbor entries
  - (9) Delete all entries in IPv6 neighbor table
  - (10) Set the hoplimit of sending router advertisement
  - (11) Set the mtu of sending router advertisement
  - (12) Set the reachable-time of sending router advertisement
  - (13) Set the retrans-timer of sending router advertisement
  - (14) Set the flag representing whether information other than the address information will be obtained via DHCPv6
  - (15) Set the flag representing whether the address information will be obtained via DHCPv6

### 3. IPv6 Tunnel configuration

- (1) Create/Delete Tunnel
- (2) Configure tunnel description
- (3) Configure Tunnel Source
- (4) Configure Tunnel Destination
- (5) Configure Tunnel Next-Hop
- (6) Configure Tunnel Mode
- (7) Configure Tunnel Routing

## 1. IPv6 Basic Configuration

### (1) Configure interface IPv6 address

Command	Explanation
Interface Configuration Mode	
<b>ipv6 address &lt;ipv6-address/prefix-length&gt; [eui-64]</b> <b>no ipv6 address &lt;ipv6-address/prefix-length&gt;</b>	Configure IPv6 address, including aggregatable global unicast addresses, site-local addresses and link-local addresses. The <b>no ipv6 address &lt;ipv6-address/prefix-length&gt;</b> command cancels IPv6 address.

(2) Set IPv6 Static Routing

Command	Explanation
Global mode	
<b>ipv6 route &lt;ipv6-prefix/prefix-length&gt; {&lt;nexthop-ipv6-address&gt; &lt;interface-type interface-number&gt;   {&lt;nexthop-ipv6-address&gt; &lt;interface-type interface-number&gt;}} [distance] no ipv6 route &lt;ipv6-prefix/prefix-length&gt; {&lt;nexthop-ipv6-address&gt; &lt;interface-type interface-number&gt;  {&lt;nexthop-ipv6-address&gt; &lt;interface-type interface-number&gt;}} [distance]</b>	Configure IPv6 static routing. The no command cancels IPv6 static routing.

## 2. IPv6 Neighbor Discovery Configuration

(1) Configure DAD Neighbor solicitation Message number

Command	Explanation
Interface Configuration Mode	
<b>ipv6 nd dad attempts &lt;value&gt; no ipv6 nd dad attempts</b>	Set the neighbor query message number sent in sequence when the interface makes duplicate address detection. The no command resumes default value (1).

(2) Configure Send Neighbor solicitation Message Interval

Command	Explanation
Interface Configuration Mode	
<b>ipv6 nd ns-interval &lt;seconds&gt; no ipv6 nd ns-interval</b>	Set the interval of the interface to send neighbor query message. The NO command resumes default value (1 second).

(3) Enable and disable router advertisement

Command	Explanation
Interface Configuration Mode	
<b>ipv6 nd suppress-ra no ipv6 nd suppress-ra</b>	Forbid IPv6 Router Advertisement. The NO command enables IPv6 router advertisement.

(4) Configure Router Lifespan

Command	Explanation
Interface Configuration Mode	
<b>ipv6 nd ra-lifetime &lt;seconds&gt;</b> <b>no ipv6 nd ra-lifetime</b>	Configure Router advertisement Lifespan. The NO command resumes default value (1800 seconds).

(5) Configure router advertisement Minimum Interval

Command	Explanation
Interface Configuration Mode	
<b>ipv6 nd min-ra-interval &lt;seconds&gt;</b> <b>no ipv6 nd min-ra-interval</b>	Configure the minimum interval for router advertisement. The NO command resumes default value (200 seconds).

(6) Configure router advertisement Maximum Interval

Command	Explanation
Interface Configuration Mode	
<b>ipv6 nd max-ra-interval &lt;seconds&gt;</b> <b>no ipv6 nd max-ra-interval</b>	Configure the maximum interval for router advertisement. The NO command resumes default value (600 seconds).

(7) Configure prefix advertisement parameters

Command	Explanation
Interface Configuration Mode	
<b>ipv6 nd prefix</b> <b>&lt;ipv6-address/prefix-length&gt;</b> <b>&lt;valid-lifetime&gt; &lt;preferred-lifetime&gt;</b> <b>[off-link] [no-autoconfig]</b> <b>no ipv6 nd prefix</b> <b>&lt;ipv6-address/prefix-length&gt;</b> <b>&lt;valid-lifetime&gt; &lt;preferred-lifetime&gt;</b> <b>[off-link] [no-autoconfig]</b>	Configure the address prefix and advertisement parameters of router. The NO command cancels the address prefix of routing advertisement.

(8) Configure static IPv6 neighbor Entries

Command	Explanation
Interface Configuration Mode	
<b>ipv6 neighbor &lt;ipv6-address&gt;</b> <b>&lt;hardware-address&gt; interface</b> <b>&lt;interface-type interface-name&gt;</b>	Set static neighbor table entries, including neighbor IPv6 address, MAC address and two-layer port.
<b>no ipv6 neighbor &lt;ipv6-address&gt;</b>	Delete neighbor table entries.

(9) Delete all entries in IPv6 neighbor table

Command	Explanation
Admin Mode	
<b>clear ipv6 neighbors</b>	Clear all static neighbor table entries.

(10) Set the hoplimit of sending router advertisement

Command	Explanation
Interface Configuration Mode	
<b>ipv6 nd ra-hoplimit &lt;value&gt;</b>	Set the hoplimit of sending router advertisement.

(11) Set the mtu of sending router advertisement

Command	Explanation
Interface Configuration Mode	
<b>ipv6 nd ra-mtu &lt;value&gt;</b>	Set the mtu of sending router advertisement.

(12) Set the reachable-time of sending router advertisement

Command	Explanation
Interface Configuration Mode	
<b>ipv6 nd reachable-time &lt;seconds&gt;</b>	Set the reachable-time of sending router advertisement.

(13) Set the retrans-timer of sending router advertisement

Command	Explanation
Interface Configuration Mode	
<b>ipv6 nd retrans-timer &lt;seconds&gt;</b>	Set the retrans-timer of sending router advertisement.

(14) Set the flag representing whether information other than the address information will be obtained via DHCPv6.

Command	Explanation
Interface Configuration Mode	
<b>ipv6 nd other-config-flag</b>	Set the flag representing whether information other than the address information will be obtained via DHCPv6.

(15) Set the flag representing whether the address information will be obtained via DHCPv6

Command	Explanation
Interface Configuration Mode	
<b>ipv6 nd managed-config-flag</b>	Set the flag representing whether the address information will be obtained via DHCPv6.

---

### 3. IPv6 Tunnel Configuration

#### (1) Add/Delete tunnel

Command	Explanation
Global mode	
<b>interface tunnel &lt;tnl-id&gt;</b> <b>no interface tunnel &lt;tnl-id&gt;</b>	Create a tunnel. The NO command deletes a tunnel.

#### (2) Configure tunnel description

Command	Explanation
Tunnel Configuration Mode	
<b>description &lt;desc&gt;</b> <b>no description</b>	Configure tunnel description. The NO command deletes the tunnel description.

#### (3) Configure tunnel source

Command	Explanation
Tunnel Configuration Mode	
<b>tunnel source { &lt;ipv4-address&gt; / &lt;ipv6-address&gt;   &lt;interface-name&gt; }</b> <b>no tunnel source</b>	Configure tunnel source end IPv4/IPv6 address. The NO command deletes the IPv4/IPv6 address of tunnel source end.

#### (4) Configure Tunnel Destination

Command	Explanation
Tunnel Configuration Mode	
<b>tunnel destination {&lt;ipv4-address&gt;   &lt;ipv6-address&gt;}</b> <b>no tunnel destination</b>	Configure tunnel destination end IPv4/IPv6 address. The NO command deletes the IPv4/IPv6 address of tunnel destination end.

#### (5) Configure Tunnel Next-Hop

Command	Explanation
Tunnel Configuration Mode	
<b>tunnel nexthop &lt;ipv4-address&gt;</b> <b>no tunnel nexthop</b>	Configure tunnel next-hop IPv4 address. The NO command deletes the IPv4 address of tunnel next-hop end.

## (6) Configure Tunnel Mode

Command	Explanation
Global mode	
<code>ipv6 route &lt;ipv6-address/prefix-length&gt; {&lt;interface-type interface-number&gt;   tunnel &lt;tnl-id&gt;}</code> <code>no ipv6 route &lt;ipv6-address/prefix-length&gt; {&lt;interface-type interface-number&gt;   tunnel &lt;tnl-id&gt;}</code>	Configure tunnel routing. The NO command clears tunnel routing.

## 22.2.3 IP Configuration Examples

### 22.2.3.1 Configuration Examples of IPv4

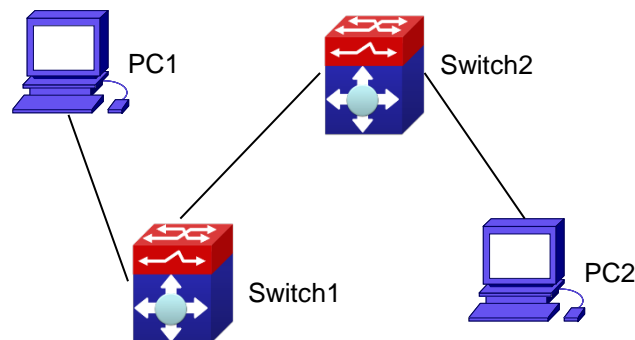

Figure 22-1 IPv4 configuration example

The user's configuration requirements are: Configure IP address of different network segments on Switch1 and Switch2, configure static routing and validate accessibility using ping function.

#### Configuration Description:

- 1 · Configure two VLANs on Switch1, namely, VLAN1 and VLAN2.
- 2 · Configure IPv4 address 192.168.1.1 255.255.255.0 in VLAN1 of Switch1, and configure IPv4 address 192.168.2.1 255.255.255.0 in VLAN2.
- 3 · Configure two VLANs on Switch2, respectively VLAN2 and VLAN3.
- 4 · Configure IPv4 address 192.168.2.2 255.255.255.0 in VLAN2 of Switch2, and configure IPv4 address 192.168.3.1 255.255.255.0 in VLAN3.
- 5 · The IPv4 address of PC1 is 192.168.1.100 255.255.255.0, and the IPv4 address of PC2 is 192.168.3.100 255.255.255.0.
- 6 · Configure static routing 192.168.3.0/24 on Switch1, and configure static routing 192.168.1.0/24 on Switch2.
- 7 · Ping each other among PCs.

Note: First make sure PC1 and Switch1 can access each other by ping, and PC2 and Switch2 can access each other by ping.

The configuration procedure is as follows:

```
Switch1(config)#interface vlan 1
Switch1(Config-if-Vlan1)#ip address 192.168.1.1 255.255.255.0
Switch1(config)#interface vlan 2
Switch1(Config-if-Vlan2)#ip address 192.168.2.1 255.255.255.0
Switch1(Config-if-Vlan2)#exit
Switch1(config)#ip route 192.168.3.0 255.255.255.0 192.168.2.2
```

```
Switch2(config)#interface vlan 2
Switch2(Config-if-Vlan2)#ip address 192.168.2.2 255.255.255.0
Switch2(config)#interface vlan 3
Switch2(Config-if-Vlan3)#ip address 192.168.3.1 255.255.255.0
Switch2(Config-if-Vlan3)#exit
Switch2(config)#ip route 192.168.1.0 255.255.255.0 192.168.2.1
```

### 22.2.3.2 Configuration Examples of IPv6

Example 1:

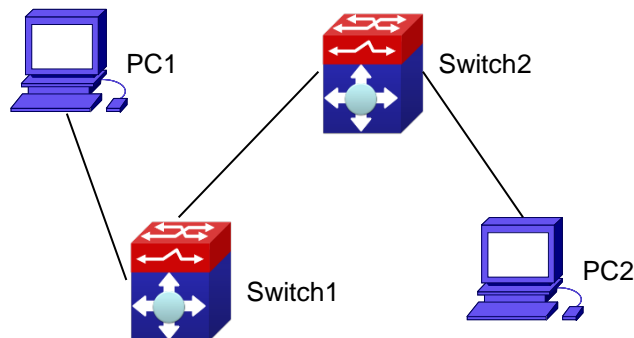

Figure 22-2 IPv6 configuration example

The user's configuration requirements are: Configure IPv6 address of different network segments on Switch1 and Switch2, configure static routing and validate reachability using ping6 function.

#### Configuration Description:

- 1 · Configure two VLANs on Switch1, namely, VLAN1 and VLAN2.
- 2 · Configure IPv6 address 2001::1/64 in VLAN1 of Switch1, and configure IPv6 address 2002::1/64 in VLAN2.
- 3 · Configure 2 VLANs on Switch2, namely, VLAN2 and VLAN3.
- 4 · Configure IPv6 address 2002::2/64 in VLAN2 of Switch2, and configure IPv6 address 2003::1/64 in VLAN3.
- 5 · The IPv6 address of PC1 is 2001::11/64, and the IPv6 address of PC2 is 2003::33/64.
- 6 · Configure static routing 2003::33/64 on Switch1, and configure static routing 2001::11/64 on Switch2.
- 7 · ping6 each other among PCs.

---

Note: First make sure PC1 and Switch1 can access each other by ping, and PC2 and Switch2 can access each other by ping.

**The configuration procedure is as follows:**

```
Switch1(Config)#interface vlan 1
Switch1(Config-if-Vlan1)#ipv6 address 2001::1/64
Switch1(Config)#interface vlan 2
Switch1(Config-if-Vlan2)#ipv6 address 2002::1/64
Switch1(Config-if-Vlan2)#exit
Switch1(Config)#ipv6 route 2003::33/64 2002::2
```

```
Switch2(Config)#interface vlan 2
Switch2(Config-if-Vlan2)#ipv6 address 2002::2/64
Switch2(Config)#interface vlan 3
Switch2(Config-if-Vlan3)#ipv6 address 2003::1/64
Switch2(Config-if-Vlan3)#exit
Switch2(Config)#ipv6 route 2001::33/64 2002::1
```

```
Switch1#ping6 2003::33
```

**Configuration result:**

```
Switch1#show run
interface Vlan1
  ipv6 address 2001::1/64
!
interface Vlan2
  ipv6 address 2002::2/64
!
interface Loopback
  mtu 3924
!
ipv6 route 2003::/64 2002::2
!
no login
!
end
```



```

Switch2#show run
interface Vlan2
  ipv6 address 2002::2/64
!
interface Vlan3
  ipv6 address 2003::1/64
!
interface Loopback
  mtu 3924
!
ipv6 route 2001::/64 2002::1
!
no login
!
End

```

### Example 2:

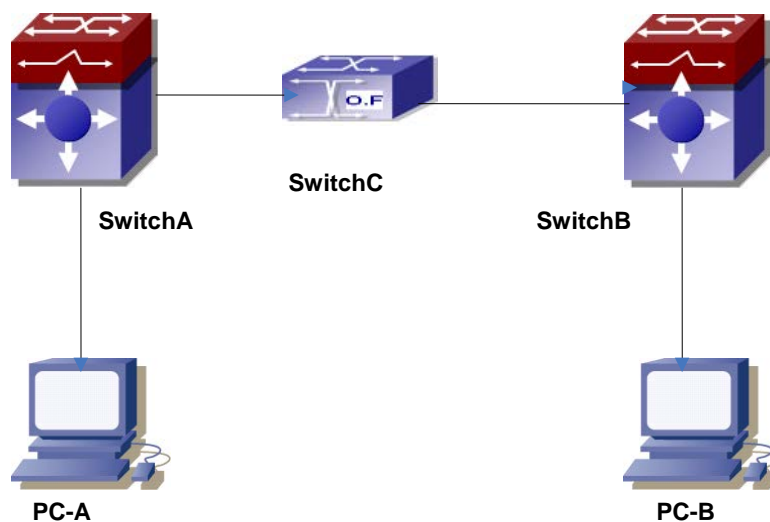

Figure 22-3 IPv6 tunnel

This case is IPv6 tunnel with the following user configuration requirements: SwitchA and SwitchB are tunnel nodes, dual-stack is supported. SwitchC only runs IPv4, PC-A and PC-B communicate.

#### Configuration Description:

1. Configure two vlans on SwitchA, namely, VLAN1 and VLAN2. VLAN1 is IPv6 domain, VLAN2 connects to IPv4 domain.
2. Configure IPv6 address 2002:caca:ca01:2::1/64 in VLAN1 of SwitchA and turn on RA function, configure IPv4 address 202.202.202.1 in VLAN2.
3. Configure two VLANs on SwitchB, namely, VLAN3 and VLAN4, VLAN4 is IPv6 domain, and VLAN3 connects to IPv4 domain.
4. Configure IPv6 address 2002:cbcb:cb01:2::1/64 in VLAN4 of SwitchB and turn on RA function,

---

configure IPv4 address 203.203.203.1 on VLAN3.

5. Configure tunnel on SwitchA, the source IPv4 address of the tunnel is 202.202.202.1, the tunnel routing is ::/0
6. Configure tunnel on SwitchB, the source IPv4 address of the tunnel is 203.203.203.1, and the tunnel routing is ::/0
7. Configure two VLANs on SwitchC, namely, VLAN2 and VLAN3. Configure IPv4 address 202.202.202.202 on VLAN2 and configure IPv4 address 203.203.203.203 on VLAN3.
8. PC-A and PC-B get the prefix of 2002 via SwitchA and SwitchB to configure IPv6 address automatically.
9. On PC-A, ping IPv6 address of PC-B

**The configuration procedure is as follows:**

```
SwitchA(Config-if-Vlan1)#ipv6 address 2002:caca:ca01:2::1/64
SwitchA(Config-if-Vlan1)#no ipv6 nd suppress-ra
SwitchA(Config-if-Vlan1)#interface vlan 2
SwitchA(Config-if-Vlan2)#ipv4 address 202.202.202.1 255.255.255.0
SwitchA(Config-if-Vlan1)#exit
SwitchA(config)# interface tunnel 1
SwitchA(Config-if-Tunnel1)#tunnel source 202.202.202.1
SwitchA(Config-if-Tunnel1)#tunnel destination 203.203.203.1
SwitchA(Config-if-Tunnel1)#tunnel mode ipv6ip
SwitchA(config)#ipv6 route ::/0 tunnel1
```

```
SwitchB(Config-if-Vlan4)#ipv6 address 2002:cbcb:cb01::2/64
SwitchB(Config-if-Vlan4)#no ipv6 nd suppress-ra
SwitchB (Config-if-Vlan3)#interface vlan 3
SwitchB (Config-if-Vlan2)#ipv4 address 203.203.203.1 255.255.255.0
SwitchB (Config-if-Vlan1)#exit
SwitchB(config)#interface tunnel 1
SwitchB(Config-if-Tunnel1)#tunnel source 203.203.203.1
SwitchB(Config-if-Tunnel1)#tunnel destination 202.202.202.1
SwitchB(Config-if-Tunnel1)#tunnel mode ipv6ip
SwitchB(config)#ipv6 route ::/0 tunnel1
```

---

## 22.2.4 IP Configuration Examples

- The router lifespan configured should not be smaller than the Send Router advertisement Interval. If the connected PC has not obtained IPv6 address, you should check RA announcement switch (the default is turned off).

## 22.3 IP Forwarding

### 22.3.1 Introduction to IP Forwarding

Gateway devices can forward IP packets from one subnet to another; such forwarding uses routes to find a path. IP forwarding of switch is done with the participation of hardware, and can achieve wire speed forwarding. In addition, flexible management is provided to adjust and monitor forwarding. Switch supports aggregation algorithm enabling/disabling optimization to adjust generation of network route entry in the switch chip and view statistics for IP forwarding and hardware forwarding chip status.

### 22.3.2 IP Route Aggregation Configuration Task

IP route aggregation configuration task:

1. Set whether IP route aggregation algorithm with/without optimization should be used

#### 1. Set whether IP route aggregation algorithm with/without optimization should be used

Command	Explanation
Global Mode	
<b>ip fib optimize</b> <b>no ip fib optimize</b>	Enables the switch to use optimized IP route aggregation algorithm; the “ <b>no ip fib optimize</b> ” disables the optimized IP route aggregation algorithm.

## 22.4 URPF

### 22.4.1 Introduction to URPF

URPF (Unicast Reverse Path Forwarding) introduces the RPF technology applied in multicast to unicast, so to protect the network from the attacks which is based on source address cheat.

When switch receives the packet, it will search the route in the route table using the source address as the destination address which is acquired from the packet. If the found router exit interface does not match the entrance interface acquired from this packet, the switch will consider this packet a fake packet and discard it. In Source Address Spoofing attacks, attackers will construct a series of messages with fake source addresses.

For applications based on IP address verification, such attacks may allow unauthorized users to access the system as some authorized ones, or even the administrator. Even if the response messages can't reach the attackers, they will also damage the targets.

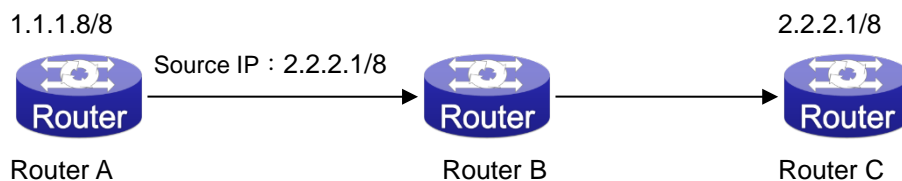

**Figure 22-4** URPF application situation

In the above figure, Router A sends requests to the server Router B by faking messages whose source address are 2.2.2.1/8 .In response, Router B will send the messages to the real "2.2.2.1/8". Such illegal messages attack both Router B and Router C. The application of URPF technology in the situation described above can avoid the attacks based on the Source Address Spoofing.

## 22.4.2 URPF Configuration Task Sequence

1. Enable URPF
2. Display and debug URPF relevant information

### 1. Globally enable URPF

Command	Explanation
Global mode	
<b>urpf enable</b> <b>no urpf enable</b>	Globally enable and disable URPF.

### 2. Display and debug URPF relevant information

Command	Explanation
Admin and Config Mode	
<b>show urpf</b>	Display which interfaces have been enabled with URPF function.

## 22.4.3 URPF Typical Example

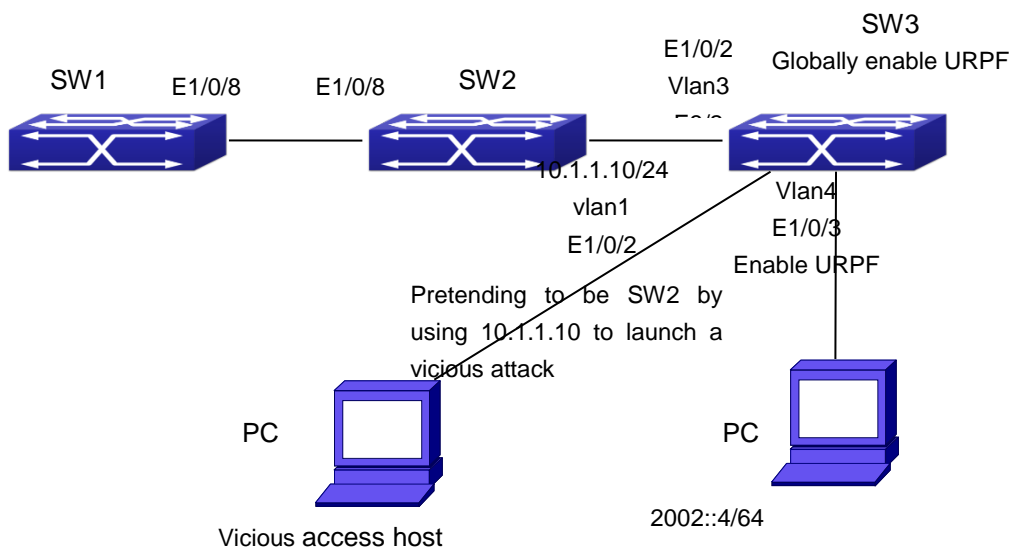

In the network, topology shown in the graph above, IP URPF function is enabled on SW3. When there is someone in the network pretending to be someone else by using his IP address to launch a vicious attack, the switch will drop all the attacking messages directly through the hardware function.

Enable the URPF function in SW3.

SW3 configuration task sequence:

```
Switch3#config
Switch3(config)#urpf enable
```

## 22.4.4 URPF Troubleshooting

- If all configurations are normal but URPF still can't operate as expected, please enable the URPF debug function and use "show urpf" command to observe whether URPF is enabled, and send the result to the technology service center.

## 22.5 ARP

### 22.5.1 Introduction to ARP

ARP (Address Resolution Protocol) is mainly used to resolve IP address to Ethernet MAC address. Switch supports both dynamic ARP and static ARP configuration. Furthermore, switch supports the configuration of proxy ARP for some applications. For instance, when an ARP request is received on the port, requesting an IP address in the same IP segment of the port but not the same physical network, if the port has enabled proxy ARP, the port would reply to the ARP with its own MAC address and forward the actual packets received. Enabling proxy ARP allows machines physically separated but of the same IP segment ignores the physical separation and communicate via proxy ARP interface as if in the same physical network.

---

## 22.5.2 ARP Configuration Task List

ARP Configuration Task List:

1. Configure static ARP
2. Configure proxy ARP
3. Clear dynamic ARP
4. Clear the statistic information of ARP messages

### 1. Configure static ARP

Command	Explanation
VLAN Interface Mode	
<b>arp</b> <ip_address> <mac_address> {interface [ethernet] <portName>} <b>no arp</b> <ip_address>	Configures a static ARP entry; the no command deletes a ARP entry of the specified IP address.

### 2. Configure proxy ARP

Command	Explanation
VLAN Interface Mode	
ip proxy-arp no ip proxy-arp	Enables the proxy ARP function for Ethernet ports: the no command disables the proxy ARP.

### 3. Clear dynamic ARP

Command	Explanation
Admin mode	
<b>clear arp-cache</b>	The command <b>clear arp-cache</b> clears the content of current ARP table, but it does not clear the current static ARP table.

### 4. Clear the statistic information of ARP message

Command	Explanation
Admin mode	
<b>clear arp traffic</b>	Clear the statistic information of ARP messages of the switch.

---

## 22.5.3 ARP Troubleshooting

If ping from the switch to directly connected network devices fails, the following can be used to check the possible cause and create a solution.

- Check whether the corresponding ARP has been learned by the switch.
- If ARP has not been learned, then enabled ARP debugging information and view the sending/receiving condition of ARP packets.
- Defective cable is a common cause of ARP problems and may disable ARP learning.

## 22.6 Hardware Tunnel Capacity Configuration

### 22.6.1 Introduction to Hardware Tunnel Capacity

Hardware Tunnel Capacity is the maximum number of tunnel and MPLS forwarded by hardware. Capacity can be adjusted by this command, increasing capacity will reduce hardware routing number supported by switch, vice versa.

### 22.6.2 Hardware Tunnel Capacity Configuration

Hardware Tunnel Capacity Configuration Task List:

1. Configure hardware tunnel capacity

#### 1. Configure hardware tunnel capacity

Command	Explanation
Global mode	
<b>hardware tunnel-capacity &lt; size&gt;</b> <b>no hardware tunnel-capacity</b>	Configure capacity of hardware tunnel and MPLS, the no command restores the default capacity.

Note: after adjust hardware tunnel capacity, it needs to reset switch to enable the valid configuration.

### 22.6.3 Hardware Tunnel Capacity Troubleshooting

- After adjust hardware tunnel capacity, it must save the configuration and reset switch, the configuration can takes effect.

---

# Chapter 23 ARP Scanning Prevention Function Configuration

## 23.1 Introduction to ARP Scanning Prevention Function

ARP scanning is a common method of network attack. In order to detect all the active hosts in a network segment, the attack source will broadcast lots of ARP messages in the segment, which will take up a large part of the bandwidth of the network. It might even do large-traffic-attack in the network via fake ARP messages to collapse of the network by exhausting the bandwidth. Usually ARP scanning is just a preface of other more dangerous attack methods, such as automatic virus infection or the ensuing port scanning, vulnerability scanning aiming at stealing information, distorted message attack, and DOS attack, etc.

Since ARP scanning threatens the security and stability of the network with great danger, so it is very significant to prevent it. Switch provides a complete resolution to prevent ARP scanning: if there is any host or port with ARP scanning features is found in the segment, the switch will cut off the attack source to ensure the security of the network.

There are two methods to prevent ARP scanning: port-based and IP-based. The port-based ARP scanning will count the number to ARP messages received from a port in a certain time range, if the number is larger than a preset threshold, this port will be “down”. The IP-based ARP scanning will count the number to ARP messages received from an IP in the segment in a certain time range, if the number is larger than a preset threshold, any traffic from this IP will be blocked, while the port related with this IP will not be “down”. These two methods can be enabled simultaneously. After a port or an IP is disabled, users can recover its state via automatic recovery function.

To improve the effect of the switch, users can configure trusted ports and IP, the ARP messages from which will not be checked by the switch. Thus the load of the switch can be effectively decreased.

## 23.2 ARP Scanning Prevention Configuration Task Sequence

- 1 · Enable the ARP Scanning Prevention function.
- 2 · Configure the threshold of the port-based and IP-based ARP Scanning Prevention
- 3 · Configure trusted ports
- 4 · Configure trusted IP
- 5 · Configure automatic recovery time
- 6 · Display relative information of debug information and ARP scanning



---

### 1. Enable the ARP Scanning Prevention function.

Command	Explanation
Global configuration mode	
<b>anti-arpscan enable</b> <b>no anti-arpscan enable</b>	Enable or disable the ARP Scanning Prevention function globally.

### 2. Configure the threshold of the port-based and IP-based ARP Scanning Prevention

Command	Explanation
Global configuration mode	
<b>anti-arpscan port-based threshold</b> <b>&lt;threshold-value&gt;</b> <b>no anti-arpscan port-based threshold</b>	Set the threshold of the port-based ARP Scanning Prevention.
<b>anti-arpscan ip-based threshold</b> <b>&lt;threshold-value&gt;</b> <b>no anti-arpscan ip-based threshold</b>	Set the threshold of the IP-based ARP Scanning Prevention.

### 3. Configure trusted ports

Command	Explanation
Port configuration mode	
<b>anti-arpscan trust &lt;port / supertrust-port&gt;</b> <b>no anti-arpscan trust &lt;port / supertrust-port&gt;</b>	Set the trust attributes of the ports.

### 4. Configure trusted IP

Command	Explanation
Global configuration mode	
<b>anti-arpscan trust ip &lt;ip-address&gt;</b> <b>[&lt;netmask&gt;]</b> <b>no anti-arpscan trust ip &lt;ip-address&gt;</b> <b>[&lt;netmask&gt;]</b>	Set the trust attributes of IP.

### 5. Configure automatic recovery time

Command	Explanation
Global configuration mode	
<b>anti-arpscan recovery enable</b> <b>no anti-arpscan recovery enable</b>	Enable or disable the automatic recovery function.
<b>anti-arpscan recovery time &lt;seconds&gt;</b> <b>no anti-arpscan recovery time</b>	Set automatic recovery time.

## 6. Display relative information of debug information and ARP scanning

Command	Explanation
Global configuration mode	
<b>anti-arpscan log enable</b> <b>no anti-arpscan log enable</b>	Enable or disable the log function of ARP scanning prevention.
<b>anti-arpscan trap enable</b> <b>no anti-arpscan trap enable</b>	Enable or disable the SNMP Trap function of ARP scanning prevention.
<b>show anti-arpscan [trust &lt;ip / port / supertrust-port&gt;   prohibited &lt;ip / port&gt;]</b>	Display the state of operation and configuration of ARP scanning prevention.
Admin Mode	
<b>debug anti-arpscan &lt;port / ip&gt;</b> <b>no debug anti-arpscan &lt;port / ip&gt;</b>	Enable or disable the debug switch of ARP scanning prevention.

## 23.3 ARP Scanning Prevention Typical Examples

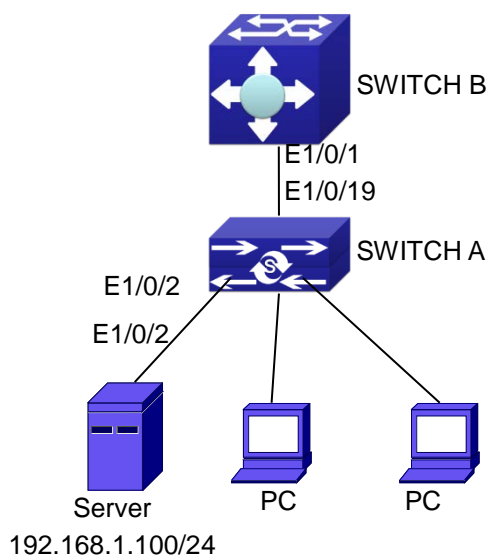

**Figure 23-1** ARP scanning prevention typical configuration example

In the network topology above, port E1/0/1 of SWITCH B is connected to port E1/0/19 of SWITCH A, the port E1/0/2 of SWITCH A is connected to file server (IP address is 192.168.1.100/24), and all the other ports of SWITCH A are connected to common PC. The following configuration can prevent ARP scanning effectively without affecting the normal operation of the system.

---

**SWITCH A configuration task sequence:**

```
SwitchA(config)#anti-arp scan enable
SwitchA(config)#anti-arp scan recovery time 3600
SwitchA(config)#anti-arp scan trust ip 192.168.1.100 255.255.255.0
SwitchA(config)#interface ethernet1/0/2
SwitchA (Config-If-Ethernet1/0/2)#anti-arp scan trust port
SwitchA (Config-If-Ethernet1/0/2)#exit
SwitchA(config)#interface ethernet1/0/19
SwitchA (Config-If-Ethernet1/0/19)#anti-arp scan trust supertrust-port
Switch A(Config-If-Ethernet1/0/19)#exit
```

**SWITCHB configuration task sequence:**

```
Switch B(config)# anti-arp scan enable
SwitchB(config)#interface ethernet1/0/1
SwitchB (Config-If-Ethernet 1/0/1)#anti-arp scan trust port
SwitchB (Config-If-Ethernet 1/0/1)exit
```

## 23.4 ARP Scanning Prevention Troubleshooting Help

- ARP scanning prevention is disabled by default. After enabling ARP scanning prevention, users can enable the debug switch, “**debug anti-arp scan**”, to view debug information.

---

# Chapter 24 Prevent ARP, ND Spoofing Configuration

## 24.1 Overview

### 24.1.1 ARP (Address Resolution Protocol)

Generally speaking, ARP (RFC-826) protocol is mainly responsible of mapping IP address to relevant 48-bit physical address, that is MAC address, for instance, IP address is 192.168.0.1, network card Mac address is 00-30-4F-FD-1D-2B. What the whole mapping process is that a host computer send broadcast data packet involving IP address information of destination host computer, ARP request, and then the destination host computer send a data packet involving its IP address and Mac address to the host, so two host computers can exchange data by MAC address.

### 24.1.2 ARP Spoofing

In terms of ARP Protocol design, to reduce redundant ARP data communication on networks, even though a host computer receives an ARP reply which is not requested by itself, it will also insert an entry to its ARP cache table, so it creates a possibility of "ARP spoofing". If the hacker wants to snoop the communication between two host computers in the same network (even if are connected by the switches), it sends an ARP reply packet to two hosts separately, and make them misunderstand MAC address of the other side as the hacker host MAC address. In this way, the direct communication is actually communicated indirectly among the hacker host computer. The hackers not only obtain communication information they need, but also only need to modify some information in data packet and forward successfully. In this sniff way, the hacker host computer doesn't need to configure intermix mode of network card, that is because the data packet between two communication sides are sent to hacker host computer on physical layer, which works as a relay.

### 24.1.3 How to prevent void ARP/ND Spoofing

There are many sniff, monitor and attack behaviors based on ARP protocol in networks, and most of attack behaviors are based on ARP spoofing, so it is very important to prevent ARP spoofing. ARP spoofing accesses normal network environment by counterfeiting legal IP address firstly, and sends a great deal of counterfeited ARP application packets to switches, after switches learn these packets, they will cover previously corrected IP, mapping of MAC address, and then some corrected IP, MAC address mapping are modified to correspondence relationship configured by attack packets so that the switch makes mistake on transfer packets, and takes an effect on the whole network. Or the switches are made used of by vicious attackers, and they intercept and capture packets transferred by switches or attack other switches, host computers or network equipment.

What the essential method on preventing attack and spoofing switches based on ARP in networks is to disable switch automatic update function; the cheater can't modify corrected MAC address in order to avoid wrong packets transfer and can't obtain other information. At one time, it doesn't interrupt the automatic learning function of ARP. Thus it prevents ARP spoofing and attack to a great extent.

ND is neighbor discovering protocol in IPv6 protocol, and it's similar to ARP on operation principle, therefore we do in the same way as preventing ARP spoofing to prevent ND spoofing and attack.

## 24.2 Prevent ARP, ND Spoofing configuration

The steps of preventing ARP, ND spoofing configuration as below:

1. Disable ARP, ND automatic update function
2. Disable ARP, ND automatic learning function
3. Changing dynamic ARP, ND to static ARP, ND

### 1. Disable ARP, ND automatic update function

Command	Explanation
Global Mode and Port Mode	
<b>ip arp-security updateprotect</b> <b>no ip arp-security updateprotect</b> <b>ipv6 nd-security updateprotect</b> <b>no ipv6 nd-security updateprotect</b>	Disable and enable ARP, ND automatic update function.

### 2. Disable ARP, ND automatic learning function

Command	Explanation
Global mode and Interface Mode	
<b>ip arp-security learnprotect</b> <b>no ip arp-security learnprotect</b> <b>ipv6 nd-security learnprotect</b> <b>no ipv6 nd-security learnprotect</b>	Disable and enable ARP, ND automatic learning function.

### 3. Function on changing dynamic ARP, ND to static ARP, ND

Command	Explanation
Global Mode and Port Mode	
<b>ip arp-security convert</b> <b>ipv6 nd-security convert</b>	Change dynamic ARP, ND to static ARP, ND.

## 24.3 Prevent ARP, ND Spoofing Example

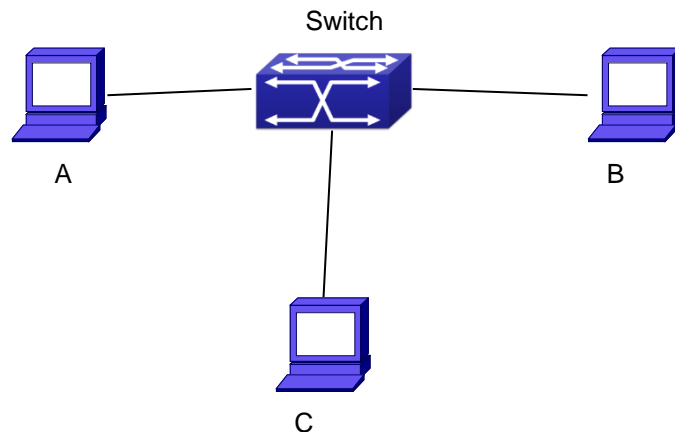

### Equipment Explanation

Equipment	Configuration	Quality
switch	IP:192.168.2.4; IP:192.168.1.4; mac: 00-00-00-00-00-04	1
A	IP:192.168.2.1; mac: 00-00-00-00-00-01	1
B	IP:192.168.1.2; mac: 00-00-00-00-00-02	1
C	IP:192.168.2.3; mac: 00-00-00-00-00-03	some

There is a normal communication between B and C on above diagram. A wants switch to forward packets sent by B to itself, so need switch sends the packets transfer from B to A. firstly A sends ARP reply packet to switch, format is: 192.168.2.3, 00-00-00-00-00-01, mapping its MAC address to C's IP, so the switch changes IP address when it updates ARP list., then data packet of 192.168.2.3 is transferred to 00-00-00-00-00-01 address (A MAC address).

In further, a transfers its received packets to C by modifying source address and destination address, the mutual communicated data between B and C are received by A unconsciously. Because the ARP list is update timely, another task for A is to continuously send ARP reply packet, and refreshes switch ARP list.

So it is very important to protect ARP list, configure to forbid ARP learning command in stable environment, and then change all dynamic ARP to static ARP, the learned ARP will not be refreshed, and protect for users.

```
Switch#config
Switch(config)#interface vlan 1
Switch(Config-If-Vlan1)#arp 192.168.2.1 00-00-00-00-00-01 interface eth 1/0/2
Switch(Config-If-Vlan1)#interface vlan 2
Switch(Config-If-Vlan2)#arp 192.168.1.2 00-00-00-00-00-02 interface eth 1/0/2
Switch(Config-If-Vlan2)#interface vlan 3
Switch(Config-If-Vlan3)#arp 192.168.2.3 00-00-00-00-00-03 interface eth 1/0/2
Switch(Config-If-Vlan3)#exit
Switch(Config)#ip arp-security learnprotect
Switch(Config)#
Switch(config)#ip arp-security convert
```

---

If the environment changing, it enable to forbid ARP refresh, once it learns ARP property, it wont be refreshed by new ARP reply packet, and protect use data from sniffing.

```
Switch#config  
Switch(config)#ip arp-security updateprotect
```

---

# Chapter 25 ARP GUARD Configuration

## 25.1 Introduction to ARP GUARD

There is serious security vulnerability in the design of ARP protocol, which is any network device, can send ARP messages to advertise the mapping relationship between IP address and MAC address. This provides a chance for ARP cheating. Attackers can send ARP REQUEST messages or ARP REPLY messages to advertise a wrong mapping relationship between IP address and MAC address, causing problems in network communication. The danger of ARP cheating has two forms: 1. PC4 sends an ARP message to advertise that the IP address of PC2 is mapped to the MAC address of PC4, which will cause all the IP messages to PC2 will be sent to PC4, thus PC4 will be able to monitor and capture the messages to PC2; 2. PC4 sends ARP messages to advertise that the IP address of PC2 is mapped to an illegal MAC address, which will prevent PC2 from receiving the messages to it. Particularly, if the attacker pretends to be the gateway and do ARP cheating, the whole network will be collapsed.

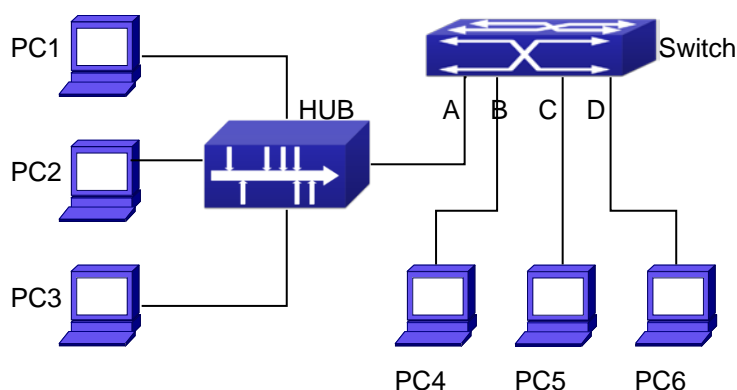

**Figure 25-1** ARP GUARD schematic diagram

We utilize the filtering entries of the switch to protect the ARP entries of important network devices from being imitated by other devices. The basic theory of doing this is that utilizing the filtering entries of the switch to check all the ARP messages entering through the port, if the source address of the ARP message is protected, the messages will be directly dropped and will not be forwarded.

ARP GUARD function is usually used to protect the gateway from being attacked. If all the accessed PCs in the network should be protected from ARP cheating, then a large number of ARP GUARD address should be configured on the port, which will take up a big part of FFP entries in the chip, and as a result, might affect other applications. So this will be improper. It is recommended that adopting FREE RESOURCE related accessing scheme. Please refer to relative documents for details.



---

## 25.2 ARP GUARD Configuration Task List

### 1. Configure the protected IP address

Command	Explanation
Port configuration mode	
<b>arp-guard ip &lt;addr&gt;</b> <b>no arp-guard ip &lt;addr&gt;</b>	Configure/delete ARP GUARD address

---

# Chapter 26 ARP Local Proxy Configuration

## 26.1 Introduction to ARP Local Proxy function

In a real application environment, the switches in the aggregation layer are required to implement local ARP proxy function to avoid ARP cheating. This function will restrict the forwarding of ARP messages in the same vlan and thus direct the L3 forwarding of the data flow through the switch.

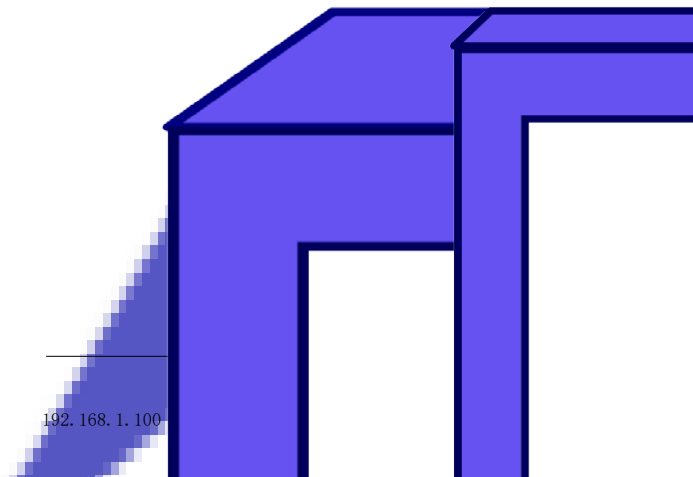

As shown in the figure above, PC1 wants to send an IP message to PC2, the overall procedure goes as follows (some non-arp details are ignored)

1. Since PC1 does not have the ARP of PC2, it sends and broadcasts ARP request.
2. Receiving the ARP message, the switch hardware will send the ARP request to CPU instead of forwarding this message via hardware, according to new ARP handling rules.
3. With local ARP proxy enabled, the switch will send ARP reply message to PC1 (to fill up its mac address)
4. After receiving the ARP reply, PC1 will create ARP, send an IP message, and set the destination MAC of the Ethernet head as the MAC of the switch.
5. After receiving the ip message, the switch will search the router table (to create router cache) and distribute hardware entries.
6. If the switch has the ARP of PC2, it will directly encapsulate the Ethernet head and send the message (the destination MAC is that of PC2)
7. If the switch does not have the ARP of PC2, it will request it and then send the ip message.

This function should cooperate with other security functions. When users configure local ARP proxy on an aggregation switch while configuring interface isolation function on the layer-2 switch connected to it, all ip flow will be forwarded on layer 3 via the aggregation switch. And due to the interface isolation, ARP messages will not be forwarded within the vlan, which means other PCs will not receive it.

## 26.2 ARP Local Proxy Function Configuration Task List

### 1 · Enable/disable ARP local proxy function

Command	Explanation
Interface vlan mode	
<b>ip local proxy-arp</b> <b>no ip local proxy-arp</b>	Enable or disable ARP local proxy function.

## 26.3 Typical Examples of ARP Local Proxy Function

As shown in the following figure, S1 is a medium/high-level layer-3 switch supporting ARP local proxy, S2 is layer-2 access switches supporting interface isolation.

Considering security, interface isolation function is enabled on S2. Thus all downlink ports of S2 is isolated from each other, making all ARP messages able to be forwarded through S1. If ARP local proxy is enabled on S1, then all interfaces on S1 isolate ARP while S1 serves as an ARP proxy. As a result, IP flow will be forwarded at layer 3 through S1 instead of S2.

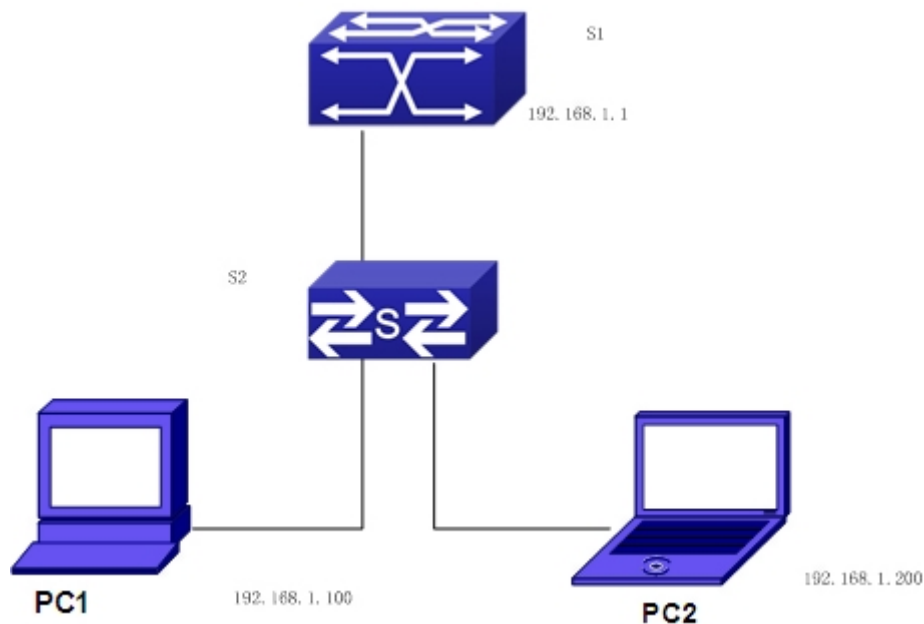

We can configure as follows:

```
Switch(config)#interface vlan 1
Switch(Config-if-Vlan1)#ip address 192.168.1.1 255.255.255.0
Switch(Config-if-Vlan1)#ip local proxy-arp
Switch(Config-if-Vlan1)#exit
```

---

## 26.4 ARP Local Proxy Function Troubleshooting

ARP local proxy function is disabled by default. Users can view the current configuration with display command. With correct configuration, by enabling debug of ARP, users can check whether the ARP proxy is normal and send proxy ARP messages.

In the process of operation, the system will show corresponding prompts if any operational error occurs.

---

# Chapter 27 Gratuitous ARP Configuration

## 27.1 Introduction to Gratuitous ARP

Gratuitous ARP is a kind of ARP request that is sent by the host with its IP address as the destination of the ARP request.

The basic working mode for SGS-6341 Series switch is as below: The Layer 3 interfaces of the switch can be configured to advertise gratuitous ARP packets period or the switch can be configured to enable to send gratuitous ARP packets in all the interfaces globally.

The purpose of gratuitous ARP is as below:

1. To reduce the frequency that the host sends ARP request to the switch. The hosts in the network will periodically send ARP requests to the gateway to update the MAC address of the gateway. If the switch advertises gratuitous ARP requests, the host will not have to send these requests. This will reduce the frequency the hosts' sending ARP requests for the gateway's MAC address.
2. Gratuitous ARP is a method to prevent ARP cheating. The switch's advertising gratuitous ARP request will force the hosts to update its ARP table cache. Thus, forged ARP of gateway cannot function.

## 27.2 Gratuitous ARP Configuration Task List

- 1 · Enable gratuitous ARP and configure the interval to send gratuitous ARP request
- 2 · Display configurations about gratuitous ARP

### 1. Enable gratuitous ARP and configure the interval to send gratuitous ARP request.

Command	Explanation
Global Configuration Mode and Interface Configuration Mode.	
<b>ip gratuitous-arp &lt;5-1200&gt;</b> <b>no ip gratuitous-arp</b>	To enable gratuitous ARP and configure the interval to send gratuitous ARP request. The no command cancels the gratuitous ARP.

### 2. Display configurations about gratuitous ARP

Command	Explanation
Admin Mode and Configuration Mode	
<b>show ip gratuitous-arp [interface vlan &lt;1-4094&gt;]</b>	To display configurations about gratuitous ARP.

## 27.3 Gratuitous ARP Configuration Example

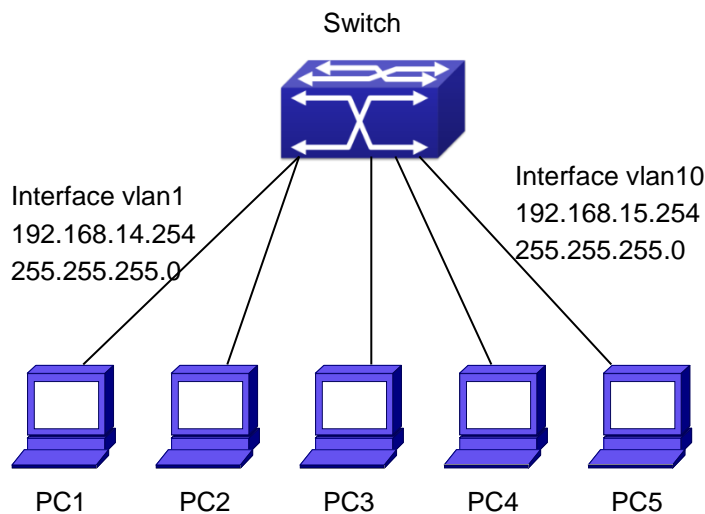

**Figure 27-1** Gratuitous ARP Configuration Example

For the network topology shown in the figure above, interface VLAN10 whose IP address is 192.168.15.254 and network address mask is 255.255.255.0 in the switch system. Three PCs – PC3, PC4, PC5 are connected to the interface. The IP address of interface VLAN 1 is 192.168.14.254, its network address mask is 255.255.255.0. Two PCs – PC1 and PC2 are connected to this interface. Gratuitous ARP can be enabled through the following configuration:

1. Configure two interfaces to use gratuitous ARP at one time.

```
Switch(config)#ip gratuitous-arp 300
Switch(config)#exit
```

2. Configure gratuitous ARP specifically for only one interface at one time.

```
Switch(config)#interface vlan 10
Switch(CONFIG-if-VLAN10)#ip gratuitous-arp 300
Switch(CONFIG-if-VLAN10)#exit
Switch(config) #exit
```

## 27.4 Gratuitous ARP Troubleshooting

Gratuitous ARP is disabled by default. And when gratuitous ARP is enabled, the debugging information about ARP packets can be retrieved through the command `debug ARP send`.

If gratuitous ARP is enabled in global configuration mode, it can be disabled only in global configuration mode. If gratuitous ARP is configured in interface configuration mode, the configuration can only be disabled in interface configuration mode.

---

# Chapter 28 Keepalive Gateway Configuration

## 28.1 Introduction to Keepalive Gateway

Ethernet port is used to process backup or load balance, for the reason that it is a broadcast channel, it may not detect the change of physical signal and fails to get to down when the gateway is down. Keepalive Gateway is introduced to detect the connectivity to the higher-up gateway, in the case that an Ethernet port connects with a higher-up gateway to form a point-to-point network topology.

For example, router connects optical terminal device and the line is up all the time. While the line between modem and remote gateway is down, it is necessary to use an effective method to detect whether the remote gateway is reachable. At present, detect gateway connectivity by sending ARP request to gateway on time, if ARP resolution is failing, shut down the interface; if ARP resolution is successful, keep the interface up.

Only layer 3 switch supports keepalive gateway function.

## 28.2 Keepalive Gateway Configuration Task List

1. To enable or disable keepalive gateway, configure the interval period that ARP request packet is sent and the retry-count after detection is failing.
2. Show keepalive gateway and IPv4 running status of the interface

**1. To enable or disable keepalive gateway, configure the interval period that ARP request packet is sent and the retry-count after detection is failing.**

Command	Explanation
Interface mode	
<b>keepalive gateway &lt;ip-address&gt; [&lt;interval-seconds&gt;   msec &lt;interval-millisecond &gt;] [retry-count]] no keepalive gateway</b>	To enable keepalive gateway, configure IP address of gateway, the interval period that ARP request packet is sent, and the retry-count after detection is failing, the no command disables the function.

## 2. Show keepalive gateway and IPv4 running status of interface

Command	Explanation
Admin and configuration mode	
<b>show keepalive gateway [interface-name]</b>	Show keepalive running status of the specified interface, if there is no interface is specified, show keepalive running status of all interfaces.
<b>show ip interface [interface-name]</b>	Show IPv4 running status of the specified interface, if there is no interface is specified, show IPv4 running status of all interfaces.

## 28.3 Keepalive Gateway Example

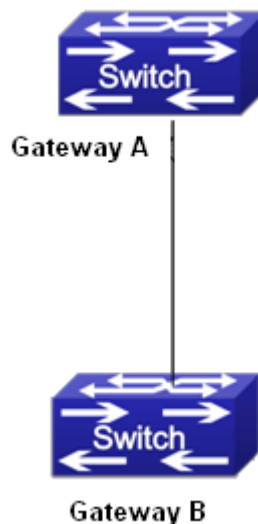

Figure 28-1 keepalive gateway typical example

In above network topology, interface address of interface vlan10 is 1.1.1.1 255.255.255.0 for gateway A, interface address of interface vlan100 is 1.1.1.2 255.255.255.0 for gateway B, gateway B supports keepalive gateway function, the configuration in the following:

1. Adopt the default interval that ARP packet is sent and the retry-count after detection is failing (the default interval is 10s, the default retry-count is 5 times)

```
Switch(config)#interface vlan 100
Switch(config-if-vlan100)#keepalive gateway 1.1.1.1
Switch(config-if-vlan100)#exit
```



---

2. Configure the interval that ARP packet is sent and the retry-count after detection is failing manually.

```
Switch(config)#interface vlan 100
Switch(config-if-vlan100)#keepalive gateway 1.1.1.1 3 3
Switch(config-if-vlan100)#exit
```

Send ARP detection once 3 seconds to detect whether gateway A is reachable, after 3 times detection is failing, gateway A is considered to be unreachable.

## 28.4 Keepalive Gateway Troubleshooting

If there is any problem happens when using keepalive gateway function, please check whether the problem is caused by the following reasons:

- Make sure the device is layer 3 switch, layer 2 switch does not support keepalive gateway
- The detection method is used to point-to-point topology mode only
- Detect IPv4 accessibility by the method, so the detection result only affects IPv4 traffic, other traffic such as IPv6 is not affected
- Physical state of interface only controlled by physical signal
- Interface can't run IPv4 after determine gateway is not reachable, so all relative IPv4 routes are deleted and IPv4 route protocol can't establish the neighbor on the interface

---

# Chapter 29 DHCP Configuration

## 29.1 Introduction to DHCP

DHCP [RFC2131] is the acronym for Dynamic Host Configuration Protocol. It is a protocol that assigns IP address dynamically from the address pool as well as other network configuration parameters such as default gateway, DNS server, and default route and host image file position within the network. DHCP is the enhanced version of BOOTP. It is a mainstream technology that can not only provide boot information for diskless workstations, but can also release the administrators from manual recording of IP allocation and reduce user effort and cost on configuration. Another benefit of DHCP is it can partially ease the pressure on IP demands, when the user of an IP leaves the network that IP can be assigned to another user.

DHCP is a client-server protocol, the DHCP client requests the network address and configuration parameters from the DHCP server; the server provides the network address and configuration parameters for the clients; if DHCP server and clients are located in different subnets, DHCP relay is required for DHCP packets to be transferred between the DHCP client and DHCP server. The implementation of DHCP is shown below:

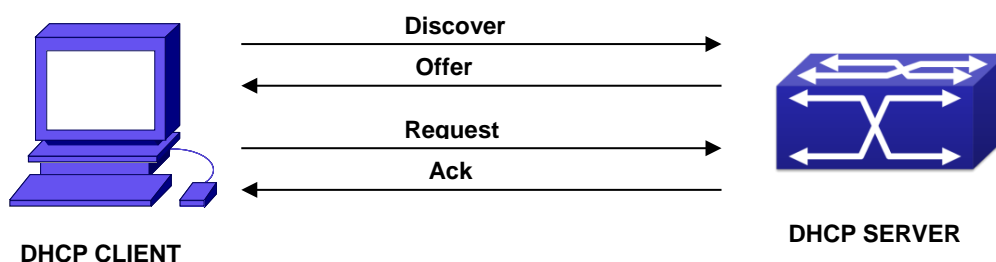

**Figure 29-1** DHCP protocol interaction

Explanation:

- 1 · DHCP client broadcasts DHCPDISCOVER packets in the local subnet.
- 2 · On receiving the DHCPDISCOVER packet, DHCP server sends a DHCPOFFER packet along with IP address and other network parameters to the DHCP client.
- 3 · DHCP client broadcast DHCPREQUEST packet with the information for the DHCP server it selected after selecting from the DHCPOFFER packets.
- 4 · The DHCP server selected by the client sends a DHCPACK packet and the client gets an IP address and other network configuration parameters.

The above four steps finish a Dynamic host configuration assignment process. However, if the DHCP server and the DHCP client are not in the same network, the server will not receive the DHCP broadcast packets sent by the client, therefore no DHCP packets will be sent to the client by the server. In this case, a DHCP relay is required to forward such DHCP packets so that the DHCP packets exchange can be completed between the DHCP client and server.

Switch can act as both a DHCP server and a DHCP relay. DHCP server supports not only dynamic IP address assignment, but also manual IP address binding (i.e. specify a specific IP address to a specified MAC address or specified device ID over a long period. The differences and relations between dynamic IP address allocation and manual IP address binding are: 1) IP address obtained dynamically can be different every time; manually bound IP address will be the same all the time. 2) The lease period of IP address obtained dynamically is the same as the lease period of the address pool, and is limited; the lease of manually bound IP address is theoretically endless. 3) Dynamically allocated address cannot be bound manually. 4) Dynamic DHCP address pool can inherit the network configuration parameters of the dynamic DHCP address pool of the related segment.

## 29.2 DHCP Server Configuration

DHCP Sever Configuration Task List:

1. Enable/Disable DHCP server
2. Configure DHCP Address pool
  - (1) Create/Delete DHCP Address pool
  - (2) Configure DHCP address pool parameters
  - (3) Configure manual DHCP address pool parameters
3. Enable logging for address conflicts

### 1. Enable/Disable DHCP server

Command	Explanation
Global Mode	
<b>service dhcp</b> <b>no service dhcp</b>	Enable DHCP server. The no command disables DHCP server.

### 2. Configure DHCP Address pool

(1) Create/Delete DHCP Address pool

Command	Explanation
Global Mode	
<b>ip dhcp pool &lt;name&gt;</b> <b>no ip dhcp pool &lt;name&gt;</b>	Configure DHCP Address pool. The no operation cancels the DHCP Address pool.

(2) Configure DHCP address pool parameters

Command	Explanation
DHCP Address Pool Mode	
<b>network-address &lt;network-number&gt;</b> <b>[mask   prefix-length]</b> <b>no network-address</b>	Configure the address scope that can be allocated to the address pool. The no operation of this command cancels the allocation address pool.

<b>default-router</b> [<address1>[<address2>[...<address8> ]]] <b>no default-router</b>	Configure default gateway for DHCP clients. The no operation cancels the default gateway.
<b>dns-server</b> [<address1>[<address2>[...<address8> ]]] <b>no dns-server</b>	Configure DNS server for DHCP clients. The no command deletes DNS server configuration.
<b>domain-name &lt;domain&gt;</b> <b>no domain-name</b>	Configure Domain name for DHCP clients; the “no domain-name” command deletes the domain name.
<b>netbios-name-server</b> [<address1>[<address2>[...<address8> ]]] <b>no netbios-name-server</b>	Configure the address for WINS server. The no operation cancels the address for server.
<b>netbios-node-type</b> {b-node h-node m-node p-node <type-number>} <b>no netbios-node-type</b>	Configure node type for DHCP clients. The no operation cancels the node type for DHCP clients.
<b>bootfile &lt;filename&gt;</b> <b>no bootfile</b>	Configure the file to be imported for DHCP clients on boot up. The no command cancels this operation.
<b>next-server</b> [<address1>[<address2>[...<address8> ]]] <b>no next-server</b> [<address1>[<address2>[...<address8> ]]]	Configure the address of the server hosting file for importing. The no command deletes the address of the server hosting file for importing.
<b>option &lt;code&gt; {ascii &lt;string&gt;   hex &lt;hex&gt;   ipaddress &lt;ipaddress&gt;}</b> <b>no option &lt;code&gt;</b>	Configure the network parameter specified by the option code. The no command deletes the network parameter specified by the option code.
<b>lease { days [hours][minutes]   infinite }</b> <b>no lease</b>	Configure the lease period allocated to addresses in the address pool. The no command deletes the lease period allocated to addresses in the address pool.
Global Mode	
<b>ip dhcp excluded-address &lt;low-address&gt; [&lt;high-address&gt;]</b> <b>no ip dhcp excluded-address &lt;low-address&gt; [&lt;high-address&gt;]</b>	Exclude the addresses in the address pool that are not for dynamic allocation.

(3) Configure manual DHCP address pool parameters

Command	Explanation
DHCP Address Pool Mode	
<b>hardware-address &lt;hardware-address&gt;</b> [ <b>{Ethernet   IEEE802 &lt;type-number&gt;}</b> ] <b>no hardware-address</b>	Specify/delete the hardware address when assigning address manually.
<b>host &lt;address&gt; [&lt;mask&gt; / &lt;prefix-length&gt; ]</b> <b>no host</b>	Specify/delete the IP address to be assigned to the specified client when binding address manually.
<b>client-identifier &lt;unique-identifier&gt;</b> <b>no client-identifier</b>	Specify/delete the unique ID of the user when binding address manually.
<b>client-name &lt;name&gt;</b> <b>no client-name</b>	Configure/delete a client name when binding address manually.

3. Enable logging for address conflicts

Command	Explanation
Global Mode	
<b>ip dhcp conflict logging</b> <b>no ip dhcp conflict logging</b>	Enable/disable logging for DHCP address to detect address conflicts.
Admin Mode	
<b>clear ip dhcp conflict &lt;address / all &gt;</b>	Delete a single address conflict record or all conflict records.

## 29.3 DHCP Relay Configuration

When the DHCP client and server are in different segments, DHCP relay is required to transfer DHCP packets. Adding a DHCP relay makes it unnecessary to configure a DHCP server for each segment, one DHCP server can provide the network configuration parameter for clients from multiple segments, which is not only cost-effective but also management-effective.

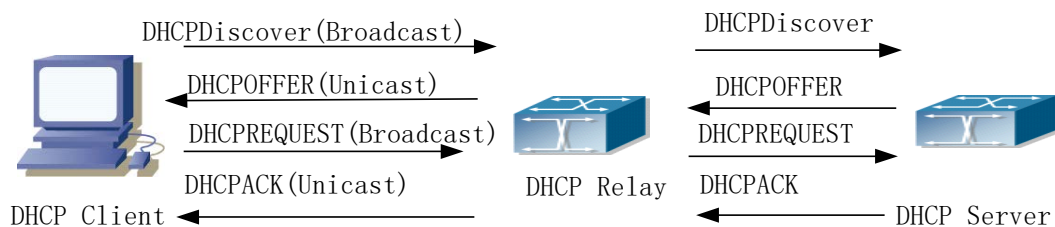

Figure 29-2 DHCP relay

As shown in the above figure, the DHCP client and the DHCP server are in different networks, the DHCP client performs the four DHCP steps as usual yet DHCP relay is added to the process.

1. The client broadcasts a DHCPDISCOVER packet, and DHCP relay inserts its own IP address to the relay agent field in the DHCPDISCOVER packet on receiving the packet, and forwards the packet to the specified DHCP server (for DHCP frame format, please refer to RFC2131).
2. On the receiving the DHCPDISCOVER packets forwarded by DHCP relay, the DHCP server sends the DHCPOFFER packet via DHCP relay to the DHCP client.
3. DHCP client chooses a DHCP server and broadcasts a DHCPREQUEST packet, DHCP relay forwards the packet to the DHCP server after processing.
4. On receiving DHCPREQUEST, the DHCP server responds with a DHCPACK packet via DHCP relay to the DHCP client.

DHCP Relay Configuration Task List:

1. Enable DHCP relay.
2. Configure DHCP relay to forward DHCP broadcast packet.

**1. Enable DHCP relay.**

Command	Explanation
Global Mode	
<b>service dhcp</b> <b>no service dhcp</b>	DHCP server and DHCP relay is enabled as the DHCP service is enabled.

**2. Configure DHCP relay to forward DHCP broadcast packet.**

Command	Explanation
Global Mode	
<b>ip forward-protocol udp bootps</b> <b>no ip forward-protocol udp bootps</b>	The UDP port 67 is used for DHCP broadcast packet forwarding.
Interface Configuration Mode	
<b>ip helper-address &lt;ipaddress&gt;</b> <b>no ip helper-address &lt;ipaddress&gt;</b>	Set the destination IP address for DHCP relay forwarding; the “ <b>no ip helper-address &lt;ipaddress&gt;</b> ”command cancels the setting.

## 29.4 DHCP Configuration Examples

**Scenario 1:**

Too save configuration efforts of network administrators and users, a company is using switch as a DHCP server. The Admin VLAN IP address is 10.16.1.2/16. The local area network for the company is divided into network A and B according to the office locations. The network configurations for location A and B are shown below.

PoolA(network 10.16.1.0)		PoolB(network 10.16.2.0)	
Device	IP address	Device	IP address
Default gateway	10.16.1.200 10.16.1.201	Default gateway	10.16.1.200 10.16.1.201
DNS server	10.16.1.202	DNS server	10.16.1.202
WINS server	10.16.1.209	WWW server	10.16.1.209
WINS node type	H-node		
Lease	3 days	Lease	1day

In location A, a machine with MAC address 00-03-22-23-dc-ab is assigned with a fixed IP address of 10.16.1.210 and named as “management”.

```
Switch(config)#service dhcp
Switch(config)#interface vlan 1
Switch(Config-Vlan-1)#ip address 10.16.1.2 255.255.0.0
Switch(Config-Vlan-1)#exit
Switch(config)#ip dhcp pool A
Switch(dhcp-A-config)#network 10.16.1.0 24
Switch(dhcp-A-config)#lease 3
Switch(dhcp-A-config)#default-route 10.16.1.200 10.16.1.201
Switch(dhcp-A-config)#dns-server 10.16.1.202
Switch(dhcp-A-config)#netbios-name-server 10.16.1.209
Switch(dhcp-A-config)#netbios-node-type H-node
Switch(dhcp-A-config)#exit
Switch(config)#ip dhcp excluded-address 10.16.1.200 10.16.1.201
Switch(config)#ip dhcp pool B
Switch(dhcp-B-config)#network 10.16.2.0 24
Switch(dhcp-B-config)#lease 1
Switch(dhcp-B-config)#default-route 10.16.2.200 10.16.2.201
Switch(dhcp-B-config)#dns-server 10.16.2.202
Switch(dhcp-B-config)#option 72 ip 10.16.2.209
Switch(dhcp-config)#exit
Switch(config)#ip dhcp excluded-address 10.16.2.200 10.16.2.201
Switch(config)#ip dhcp pool A1
Switch(dhcp-A1-config)#host 10.16.1.210
Switch(dhcp-A1-config)#hardware-address 00-03-22-23-dc-ab
Switch(dhcp-A1-config)#exit
```

**Usage Guide:** When a DHCP/BOOTP client is connected to a VLAN1 port of the switch, the client can only get its address from 10.16.1.0/24 instead of 10.16.2.0/24. This is because the broadcast packet from the client will be requesting the IP address in the same segment of the VLAN interface after VLAN interface forwarding, and the VLAN interface IP address is 10.16.1.2/24, therefore the IP address assigned to the client will belong to 10.16.1.0/24.

If the DHCP/BOOTP client wants to have an address in 10.16.2.0/24, the gateway forwarding broadcast packets of the client must belong to 10.16.2.0/24. The connectivity between the client gateway and the switch must be ensured for the client to get an IP address from the 10.16.2.0/24 address pool.

## Scenario 2:

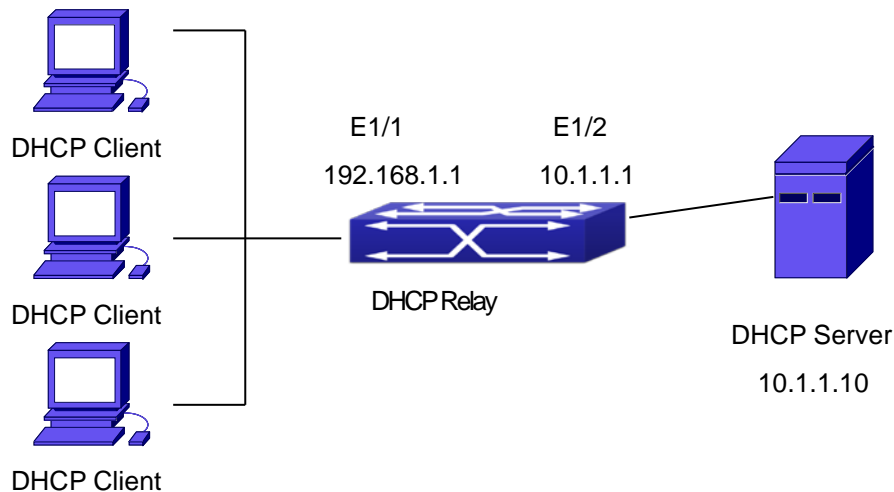

Figure 29-3 DHCP Relay Configuration

As shown in the above figure, route switch is configured as a DHCP relay. The DHCP server address is 10.1.1.10, TFTP server address is 10.1.1.20, the configuration steps is as follows:

```
Switch(config)#service dhcp
Switch(config)#interface vlan 1
Switch(Config-if-Vlan1)#ip address 192.168.1.1 255.255.255.0
Switch(Config-if-Vlan1)#exit
Switch(config)#vlan 2
Switch(Config-Vlan-2)#exit
Switch(config)#interface Ethernet 1/0/2
Switch(Config-Erthernet1/0/2)#switchport access vlan 2
Switch(Config-Erthernet1/0/2)#exit
Switch(config)#interface vlan 2
Switch(Config-if-Vlan2)#ip address 10.1.1.1 255.255.255.0
Switch(Config-if-Vlan2)#exit
Switch(config)#ip forward-protocol udp bootps
Switch(config)#interface vlan 1
Switch(Config-if-Vlan1)#ip help-address 10.1.1.10
Switch(Config-if-Vlan1)#exit
```



It is recommended to use the combination of command **ip forward-protocol udp <port>** and **ip helper-address <ipaddress>**. **ip helper-address** can only be configured for ports on layer 3 and cannot be configured on layer 2 ports directly.

## 29.5 DHCP Troubleshooting

If the DHCP clients cannot obtain IP addresses and other network parameters, the following procedures can be followed when DHCP client hardware and cables have been verified ok.



- 
- Verify the DHCP server is running, start the related DHCP server if not running. If the DHCP clients and servers are not in the same physical network, verify the router responsible for DHCP packet forwarding has DHCP relay function. If DHCP relay is not available for the intermediate router, it is recommended to replace the router or upgrade its software to one that has a DHCP relay function.
  - In such case, DHCP server should be examined for an address pool that is in the same segment of the switch VLAN, such a pool should be added if not present, and (This does not indicate switch cannot assign IP address for different segments, see solution 2 for details.)
  - In DHCP service, pools for dynamic IP allocation and manual binding are conflicting, i.e., if command “**network-address**” and “**host**” are run for a pool, only one of them will take effect; furthermore, in manual binding, only one IP-MAC binding can be configured in one pool. If multiple bindings are required, multiple manual pools can be created and IP-MAC bindings set for each pool. New configuration in the same pool overwrites the previous configuration.

# Chapter 30 DHCPv6 Configuration

## 30.1 Introduction to DHCPv6

DHCPv6 [RFC3315] is the IPv6 version for Dynamic Host Configuration Protocol (DHCP). It is a protocol that assigns IPv6 address as well as other network configuration parameters such as DNS address, and domain name to DHCPv6 client, DHCPv6 is a conditional auto address configuration protocol relative to IPv6. In the conditional address configuration process, DHCPv6 server assigns a complete IPv6 address to client, and provides DNS address, domain name and other configuration information, maybe the DHCPv6 packet can transmit through relay delegation, at last the binding of IPv6 address and client can be recorded by DHCPv6 server, all that can enhance the management of network; DHCPv6 server can also provide non state DHCPv6 service, that is only assigns DNS address and domain name and other configuration information but not assigns IPv6 address, it can solve the bug of IPv6 auto address configuration in non state; DHCPv6 can provide extend function of DHCPv6 prefix delegation, upstream route can assign address prefix to downstream route automatically, that achieve the IPv6 address auto assignment in levels of network environment, and resolved the problem of ISP and IPv6 network dispose.

There are three entities in the DHCPv6 protocol – the client, the relay and the server. The DHCPv6 protocol is based on the UDP protocol. The DHCPv6 client sends request messages to the DHCP server or DHCP relay with the destination port as 547, and the DHCPv6 server and relay send replying messages with the destination port as 546. The DHCPv6 client sends solicit or request messages with the multicast address – ff02::1:2 for DHCP relay and server.

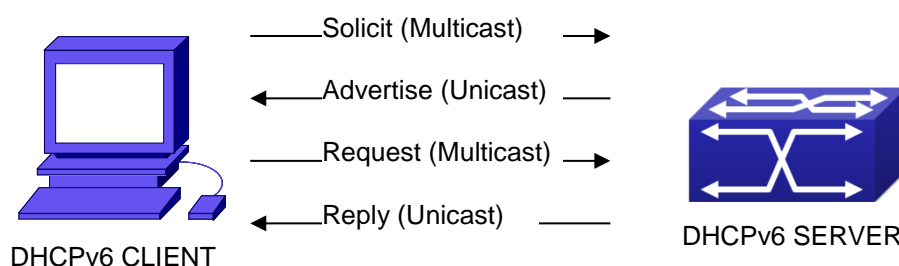

**Figure 30-1** DHCPv6 negotiation

When a DHCPv6 client tries to request an IPv6 address and other configurations from the DHCPv6 server, the client has to find the location of the DHCP server, and then request configurations from the DHCP server.

1. In the time of located server, the DHCP client tries to find a DHCPv6 server by broadcasting a SOLICIT packet to all the DHCP relay delegation and server with broadcast address as FF02::1:2.
2. Any DHCP server which receives the request, will reply the client with an ADVERTISE message, which includes the identity of the server –DUID, and its priority.
3. It is possible that the client receives multiple ADVERTISE messages. The client should select one and reply it with a REQUEST message to request the address which is advertised in the ADVERTISE message.

- 
- The selected DHCPv6 server then confirms the client about the IPv6 address and any other configuration with the REPLY message.

The above four steps finish a Dynamic host configuration assignment process. However, if the DHCPv6 server and the DHCPv6 client are not in the same network, the server will not receive the DHCPv6 broadcast packets sent by the client, therefore no DHCPv6 packets will be sent to the client by the server. In this case, a DHCPv6 relay is required to forward such DHCPv6 packets so that the DHCPv6 packets exchange can be completed between the DHCPv6 client and server.

At the time this manual is written, DHCPv6 server, relay and prefix delegation client have been implemented on the switch. When the DHCPv6 relay receives any messages from the DHCPv6 client, it will encapsulate the request in a Relay-forward packet and deliver it to the next DHCPv6 relay or the DHCPv6 server. The DHCPv6 messages coming from the server will be encapsulated as relay reply packets to the DHCPv6 relay. The relay then removes the encapsulation and delivers it the DHCPv6 client or the next DHCPv6 relay in the network.

For DHCPv6 prefix delegation where DHCPv6 server is configured on the PE router and DHCPv6 client is configured on the CPE router, the CPE router is able to send address prefix allocation request to the PE router and get a pre-configured address prefix, but not set the address prefix manually. The protocol negotiation between the client and the prefix delegation client is quite similar to that when getting a DHCPv6 address. Then the CPE router divides the allocated prefix – whose length should be less than 64 characters, into 64 subnets. The divided address prefix will be advertised through routing advertisement messages (RA) to the host directly connected to the client.

## 30.2 DHCPv6 Server Configuration

DHCPv6 server configuration task list as below:

- To enable/disable DHCPv6 service
- To configure DHCPv6 address pool
  - To achieve/delete DHCPv6 address pool
  - To configure parameter of DHCPv6 address pool
- To enable DHCPv6 server function on port

### 1. To enable/disable DHCPv6 service

Command	Explanation
Global Mode	
<b>service dhcpv6</b> <b>no service dhcpv6</b>	To enable DHCPv6 service.

### 2. To configure DHCPv6 address pool

- To achieve/delete DHCPv6 address pool

Command	Explanation
Global Mode	
<b>ipv6 dhcp pool &lt;poolname&gt;</b> <b>no ipv6 dhcp pool &lt;poolname&gt;</b>	To configure DHCPv6 address pool.

(2) To configure parameter of DHCPv6 address pool

Command	Explanation
DHCPv6 address pool Configuration Mode	
<b>network-address</b> <b>&lt;ipv6-pool-start-address&gt;</b> <b>{&lt;ipv6-pool-end-address&gt;  </b> <b>&lt;prefix-length&gt;} [eui-64]</b> <b>no network-address</b>	To configure the range of IPv6 address assignable of address pool.
<b>dns-server &lt;ipv6-address&gt;</b> <b>no dns-server &lt;ipv6-address&gt;</b>	To configure DNS server address for DHCPv6 client.
<b>domain-name &lt;domain-name&gt;</b> <b>no domain-name &lt;domain-name&gt;</b>	To configure DHCPv6 client domain name.
<b>excluded-address &lt;ipv6-address&gt;</b> <b>no excluded-address &lt;ipv6-address&gt;</b>	To exclude IPv6 address which isn't used for dynamic assignment in address pool.
<b>lifetime {&lt;valid-time&gt;   infinity}</b> <b>{&lt;preferred-time&gt;   infinity}</b> <b>no lifetime</b>	To configure valid time or preferred time of DHCPv6 address pool.

3. To enable DHCPv6 server function on port.

Command	Explanation
Interface Configuration Mode	
<b>ipv6 dhcp server &lt;poolname&gt;</b> <b>[preference &lt;value&gt;] [rapid-commit]</b> <b>[allow-hint]</b> <b>no ipv6 dhcp server &lt;poolname&gt;</b>	To enable DHCPv6 server function on specified port, and binding the used DHCPv6 address pool.

## 30.3 DHCPv6 Relay Delegation Configuration

DHCPv6 relay delegation configuration task list as below:

- 1 · To enable/disable DHCPv6 service
- 2 · To configure DHCPv6 relay delegation on port

1. To enable DHCPv6 service

Command	Explanation
Global Mode	
<b>service dhcpv6</b> <b>no service dhcpv6</b>	To enable DHCPv6 service.

## 2. To configure DHCPv6 relay delegation on port

Command	Explanation
Interface Configuration Mode	
<b>ipv6 dhcp relay destination</b> {[<ipv6-address>] [interface { <interface-name>   vlan <1-4096>}]} <b>no ipv6 dhcp relay destination</b> {[<ipv6-address>] [interface { <interface-name>   vlan <1-4096>}]} 	To specify the destination address of DHCPv6 relay transmit; The no form of this command delete the configuration.

## 30.4 DHCPv6 Prefix Delegation Server Configuration

DHCPv6 prefix delegation server configuration task list as below:

1. To enable/delete DHCPv6 service
2. To configure prefix delegation pool
3. To configure DHCPv6 address pool
  - (1) To achieve/delete DHCPv6 address pool
  - (2) To configure prefix delegation pool used by DHCPv6 address pool
  - (3) To configure static prefix delegation binding
  - (4) To configure other parameters of DHCPv6 address pool
4. To enable DHCPv6 prefix delegation server function on port

### 1. To enable/delete DHCPv6 service

Command	Explanation
Global Mode	
<b>service dhcpv6</b> <b>no service dhcpv6</b>	To enable DHCPv6 service.

### 2. To configure prefix delegation pool

Command	Explanation
Global Mode	
<b>ipv6 local pool &lt;poolname&gt;</b> <b>&lt;prefix prefix-length&gt;</b> <b>&lt;assigned-length&gt;</b> <b>no ipv6 local pool &lt;poolname&gt;</b>	To configure prefix delegation pool.

---

### 3. To configure DHCPv6 address pool

(1) To achieve/delete DHCPv6 address pool

Command	Explanation
Global Mode	
<b>ipv6 dhcp pool &lt;poolname&gt;</b> <b>no ipv6 dhcp pool &lt;poolname&gt;</b>	To configure DHCPv6 address pool.

(2) To configure prefix delegation pool used by DHCPv6 address pool

Command	Explanation
DHCPv6 address pool Configuration Mode	
<b>prefix-delegation pool &lt;poolname&gt;</b> <b>[lifetime { &lt;valid-time&gt;   infinity}</b> <b>{ &lt;preferred-time&gt;   infinity}]</b> <b>no prefix-delegation pool &lt;poolname&gt;</b>	To specify prefix delegation pool used by DHCPv6 address pool, and assign usable prefix to client.

(3) To configure static prefix delegation binding

Command	Explanation
DHCPv6 address pool Configuration Mode	
<b>prefix-delegation</b> <b>&lt;ipv6-prefix/prefix-length&gt;</b> <b>&lt;client-DUID&gt; [iaid &lt;iaid&gt; ] [lifetime</b> <b>{ &lt;valid-time&gt;   infinity}</b> <b>{ &lt;preferred-time&gt;   infinity}]</b> <b>no prefix-delegation</b> <b>&lt;ipv6-prefix/prefix-length&gt;</b> <b>&lt;client-DUID&gt; [iaid &lt;iaid&gt; ]</b>	To specify IPv6 prefix and any prefix required static binding by client.

(4) To configure other parameter of DHCPv6 address pool

Command	Explanation
DHCPv6 address pool Configuration Mode	
<b>dns-server &lt;ipv6-address&gt;</b> <b>no dns-server &lt;ipv6-address&gt;</b>	To configure DNS server address for DHCPv6 client.
<b>domain-name &lt;domain-name&gt;</b> <b>no domain-name &lt;domain-name&gt;</b>	To configure domain name for DHCPv6 client.

#### 4. To enable DHCPv6 prefix delegation server function on port

Command	Explanation
Interface Configuration Mode	
<b>ipv6 dhcp server &lt;poolname&gt;</b> <b>[preference &lt;value&gt;] [rapid-commit]</b> <b>[allow-hint]</b> <b>no ipv6 dhcp server &lt;poolname&gt;</b>	To enable DHCPv6 server function on specified port, and binding used DHCPv6 address pool.

## 30.5 DHCPv6 Prefix Delegation Client Configuration

DHCPv6 prefix delegation client configuration task list as below:

1. To enable/disable DHCPv6 service
2. To enable DHCPv6 prefix delegation client function on port

#### 1. To enable/disable DHCPv6 service

Command	Explanation
Global Mode	
<b>service dhcpv6</b> <b>no service dhcpv6</b>	To enable DHCPv6 service.

#### 2. To enable DHCPv6 prefix delegation client function on port

Command	Explanation
Interface Configuration Mode	
<b>ipv6 dhcp client pd &lt;prefix-name&gt;</b> <b>[rapid-commit]</b> <b>no ipv6 dhcp client pd</b>	To enable client prefix delegation request function on specified port, and the prefix obtained associate with universal prefix configured.

## 30.6 DHCPv6 Configuration Examples

#### Example1:

When deploying IPv6 networking, SGS-6341 Series switches can be configured as DHCPv6 server in order to manage the allocation of IPv6 addresses. Both the state and the stateless DHCPv6 are supported.

#### Topology:

The access layer use Switch1 switch to connect users of dormitory buildings; Switch2 is configured as DHCPv6 relay delegation in primary aggregation layer; Switch3 is configured as DHCPv6 server in secondary aggregation layer, and connected with backbone network or higher aggregation layers; The Windows Vista which be provided with DHCPv6 client must load on PC.

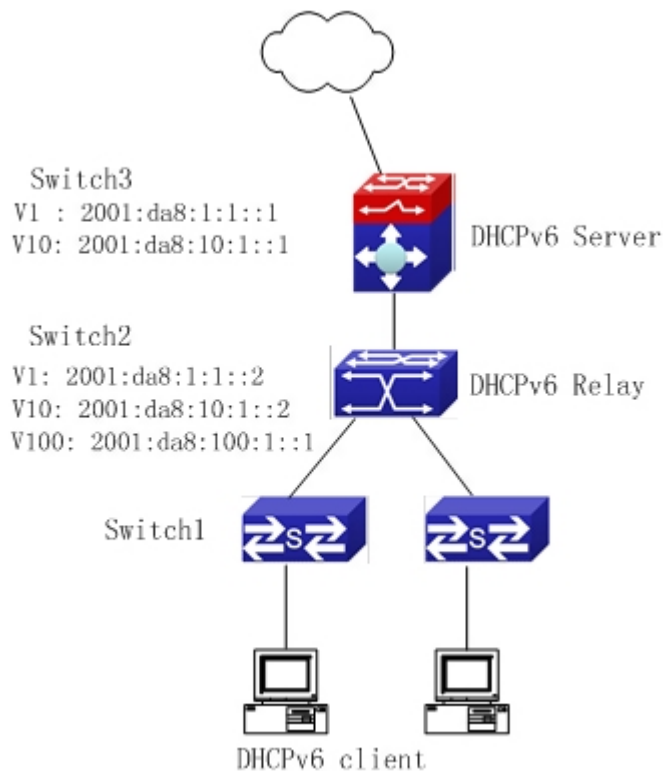

#### Usage guide:

Switch3 configuration :

```
Switch3>enable
Switch3#config
Switch3(config)#service dhcpv6
Switch3(config)#ipv6 dhcp pool EastDormPool
Switch3(dhcpv6-EastDormPool-config)#network-address 2001:da8:100:1::1 2001:da8:100:1::100
Switch3(dhcpv6-EastDormPool-config)#excluded-address 2001:da8:100:1::1
Switch3(dhcpv6-EastDormPool-config)#dns-server 2001:da8::20
Switch3(dhcpv6-EastDormPool-config)#dns-server 2001:da8::21
Switch3(dhcpv6-EastDormPool-config)#domain-name dhcpv6.com
Switch3(dhcpv6-EastDormPool-config)#lifetime 1000 600
Switch3(dhcpv6-EastDormPool-config)#exit
Switch3(config)#interface vlan 1
Switch3(Config-if-Vlan1)#ipv6 address 2001:da8:1:1::1/64
Switch3(Config-if-Vlan1)#exit
Switch3(config)#interface vlan 10
Switch3(Config-if-Vlan10)#ipv6 address 2001:da8:10:1::1/64
Switch3(Config-if-Vlan10)#ipv6 dhcp server EastDormPool preference 80
Switch3(Config-if-Vlan10)#exit
Switch3(config)#
```



---

Switch2 configuration :

```
Switch2>enable
Switch2#config
Switch2(config)#service dhcpv6
Switch2(config)#interface vlan 1
Switch2(Config-if-Vlan1)#ipv6 address 2001:da8:1:1::2/64
Switch2(Config-if-Vlan1)#exit
Switch2(config)#interface vlan 10
Switch2(Config-if-Vlan10)#ipv6 address 2001:da8:10:1::2/64
Switch2(Config-if-Vlan10)#exit
Switch2(config)#interface vlan 100
Switch2(Config-if-Vlan100)#ipv6 address 2001:da8:100:1::1/64
Switch2(Config-if-Vlan100)#no ipv6 nd suppress-ra
Switch2(Config-if-Vlan100)#ipv6 nd managed-config-flag
Switch2(Config-if-Vlan100)#ipv6 nd other-config-flag
Switch2(Config-if-Vlan100)#ipv6 dhcp relay destination 2001:da8:10:1::1
Switch2(Config-if-Vlan100)#exit
Switch2(config)#
```

### Example2:

When the network operator is deploying IPv6 networks, network automatically configuration can be achieved through the prefix delegation allocation of IPv6 addresses, in stead of configuring manually for each switch:

1. To configure the switching or routing device which is connected to the client switch as DHCPv6 prefix delegation server, that is to setup a local database for the relationship between the allocated prefix and the DUID of the client switch.
2. To configure the switch as the prefix delegation client, and make the client switch to get IPv6 address prefix from the prefix delegation server, through a process which is much like the process of DHCPv6 address allocation.
3. The edge devices which receive the address prefix, send routing advertisement - RA messages, to the client hosts about the address prefix through the interface which is connected to the hosts, then the hosts get an valid IPv6 address through stateless auto configuration, while at the same time, the stateless DHCPv6 server will be configured for the interface, in order to provide the DHCPv6 client with information such as DNS, and domain name, etc.

### Network Topology:

The edge switch is a Switch1 switch. The interface connected to the trunk switch which is Switch2, is configured as the prefix delegation client. The interfaces connected to hosts, are configured as stateless DHCPv6 servers to provide the hosts with stateless information such as DNS and domain names, also routing advertisement of stateless address allocation is enabled for the host interfaces; On Switch2, the prefix delegation server is configured, and routing advertisement of state address allocation is enabled; On the host side, DHCPv6 client capable operating system such Windows Vista should be installed.

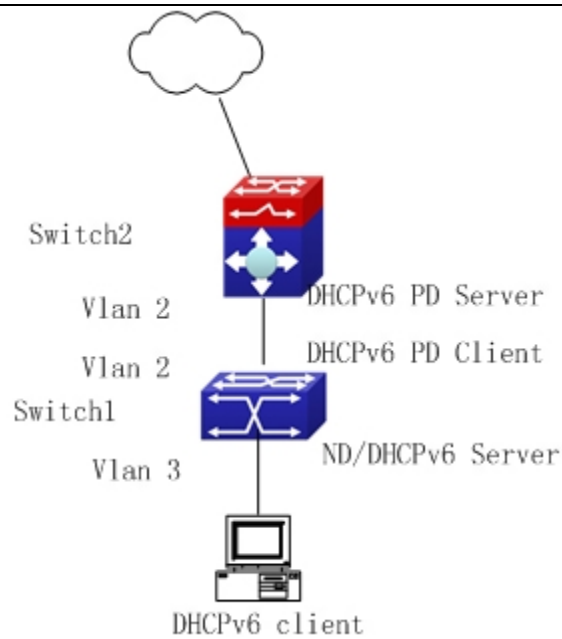

**Usage guide:**

Switch2 configuration

```
Switch2>enable
Switch2#config
Switch2(config)#interface vlan 2
Switch2(Config-if-Vlan2)#ipv6 address 2001:da8:1100::1/64
Switch2(Config-if-Vlan2)#exit
Switch2(config)#service dhcpv6
Switch2(config)#ipv6 local pool client-prefix-pool 2001:da8:1800::/40 48
Switch2(config)#ipv6 dhcp pool dhcp-pool
Switch2(dhcpv6-dhcp-pool-config)#prefix-delegation pool client-prefix-pool 1800 600
Switch2(dhcpv6-dhcp-pool-config)#exit
Switch2(config)#interface vlan 2
Switch2(Config-if-Vlan2)#ipv6 dhcp server dhcp-pool
Switch2(Config-if-Vlan2)#exit
```

---

## Switch1 configuration

```
Switch1>enable
Switch1#config
Switch1(config)#service dhcpv6
Switch1(config)#interface vlan 2
Switch1(Config-if-Vlan2)#ipv6 dhcp client pd prefix-from-provider
Switch1(Config-if-Vlan2)#exit
Switch1(config)#interface vlan 3
Switch1(Config-if-Vlan3)#ipv6 address prefix-from-provider 0:0:0:1::1/64
Switch1(Config-if-Vlan3)#exit
Switch1(config)#ipv6 dhcp pool foo
Switch1(dhcpv6-foo-config)#dns-server 2001:4::1
Switch1(dhcpv6-foo-config)#domain-name www.ipv6.org
Switch1(dhcpv6-foo-config)#exit
Switch1(config)#interface vlan 3
Switch1(Config-if-Vlan3)#ipv6 dhcp server foo
Switch1(Config-if-Vlan3)#ipv6 nd other-config-flag
Switch1(Config-if-Vlan3)#no ipv6 nd suppress-ra
Switch1(Config-if-Vlan3)#exit
```

## 30.7 DHCPv6 Troubleshooting

If the DHCPv6 clients cannot obtain IPv6 addresses and other network parameters, the following procedures can be followed when DHCPv6 client hardware and cables have been verified ok:

- Verify the DHCPv6 server is running, start the related DHCP v6 server function if not running;
- If the DHCPv6 clients and servers are not in the same physical network, verify the router responsible for DHCPv6 packet forwarding has DHCPv6 relay function. If DHCPv6 relay is not available for the intermediate router, it is recommended to replace the router or upgrade its software to one that has a DHCPv6 relay function;
- Sometimes hosts are connected to the DHCPv6 enabled switches, but can not get IPv6 addresses. In this situation, it should be checked first whether the ports which the hosts are connected to, are connected with the port which the DHCPv6 server is connected to. If connected directly, it should be checked then whether the IPv6 address pool of the VLAN which the port belongs to, is in the same subnet with the address pool configure in the DHCPv6 server; If not connected directly, and any layer three DHCPv6 relay is configured between the hosts and the DHCPv6 server, it should be checked first whether an valid IPv6 address has been configured for the switch interface which the hosts are connected to. If not configured, configure an valid IPv6 address. If configured, it should be checked whether the configured IPv6 address is in the same subnet with the DHCPv6 server. If not, please add it to the address pool.

---

# Chapter 31 DHCP option 82 Configuration

## 31.1 Introduction to DHCP option 82

DHCP option 82 is the Relay Agent Information Option, its option code is 82. DHCP option 82 is aimed at strengthening the security of DHCP servers and improving the IP address configuration policy. The Relay Agent adds option 82 (including the client's physical access port, the access device ID and other information), to the DHCP request message from the client then forwards the message to DHCP server. When the DHCP server which supports the option 82 function receives the message, it will allocate an IP address and other configuration information for the client according to preconfigured policies and the option 82 information in the message. At the same time, DHCP server can identify all the possible DHCP attack messages according to the information in option 82 and defend against them. DHCP Relay Agent will peel the option 82 from the reply messages it receives, and forward the reply message to the specified port of the network access device, according to the physical port information in the option. The application of DHCP option 82 is transparent for the client.

### 31.1.1 DHCP option 82 Message Structure

A DHCP message can have several option segments; option 82 is one of them. It has to be placed after other options but before option 255. The following is its format:

Code	Len	Agent Information Field					
82	N	i1	i2	i3	i4	...	iN

Code: represents the sequence number of the relay agent information option, the option 82 is called so because RFC3046 is defined as 82.

Len: the number of bytes in Agent Information Field, not including the two bytes in Code segment and Len segment.

Option 82 can have several sub-options, and need at least one sub-option. RFC3046 defines the following two sub-options, whose formats are showed as follows:

SubOpt	Len	Sub-option Value					
1	N	s1	s2	s3	s4	...	sN

SubOpt	Len	Sub-option Value					
2	N	i1	i2	i3	i4	...	iN

SubOpt: the sequence number of sub-option, the sequence number of Circuit ID sub-option is 1, the sequence number of Remote ID sub-option is 2.

Len: the number of bytes in Sub-option Value, not including the two bytes in SubOpt segment and Len segment.

---

## 31.1.2 option 82 Working Mechanism

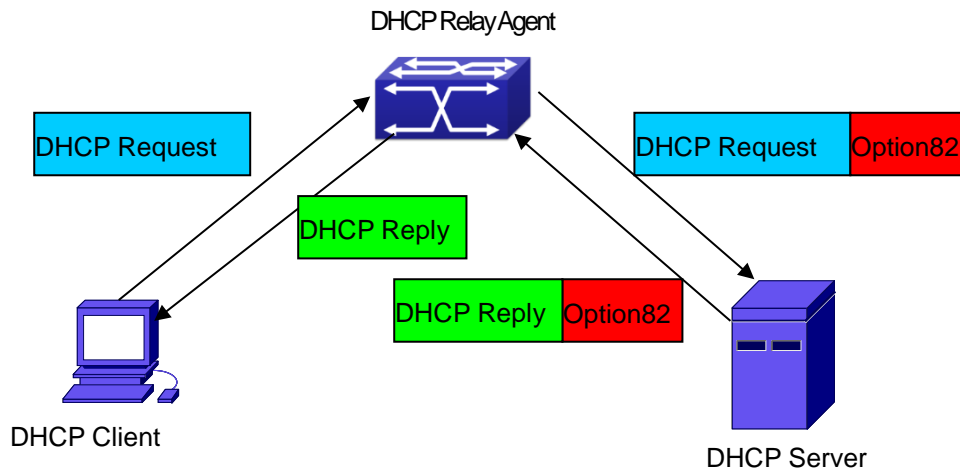

DHCP option 82 flow chart

If the DHCP Relay Agent supports option 82, the DHCP client should go through the following four steps to get its IP address from the DHCP server: discover, offer, select and acknowledge. The DHCP protocol follows the procedure below:

- 1) DHCP client sends a request broadcast message while initializing. This request message does not have option 82.
- 2) DHCP Relay Agent will add the option 82 to the end of the request message it receives, then relay and forward the message to the DHCP server. By default, the sub-option 1 of option 82 (Circuit ID) is the interface information of the switch connected to the DHCP client (VLAN name and physical port name), but the users can configure the Circuit ID as they wish. The sub-option 2 of option 82 (Remote ID) is the MAC address of the DHCP relay device.
- 3) After receiving the DHCP request message, the DHCP server will allocate IP address and other information for the client according to the information and preconfigured policy in the option segment of the message. Then it will forward the reply message with DHCP configuration information and option 82 information to DHCP Relay Agent.
- 4) DHCP Relay Agent will peel the option 82 information from the reply message sent by DHCP server, and then forward the message with DHCP configuration information to the DHCP client.

## 31.2 DHCP option 82 Configuration Task List

- 1 · Enabling the DHCP option 82 of the Relay Agent
- 2 · Configure the DHCP option 82 attributes of the interface
- 3 · Enable the DHCP option 82 of server
- 4 · Configure DHCP option 82 default format of Relay Agent
- 5 · Configure delimiter
- 6 · Configure creation method of option82
- 7 · Diagnose and maintain DHCP option 82

1. Enabling the DHCP option 82 of the Relay Agent.

Command	Explanation
Global mode	
<b>ip dhcp relay information option</b> <b>no ip dhcp relay information option</b>	Set this command to enable the option 82 function of the switch Relay Agent. The “no ip dhcp relay information option” is used to disable the option 82 function of the switch Relay Agent.

2. Configure the DHCP option 82 attributes of the interface

Command	Explanation
Interface configuration mode	
<b>ip dhcp relay information policy {drop   keep   replace}</b> <b>no ip dhcp relay information policy</b>	This command is used to set the retransmitting policy of the system for the received DHCP request message which contains option 82. The drop mode means that if the message has option82, then the system will drop it without processing; keep mode means that the system will keep the original option 82 segment in the message, and forward it to the server to process; replace mode means that the system will replace the option 82 segment in the existing message with its own option 82, and forward the message to the server to process. The “no ip dhcp relay information policy” will set the retransmitting policy of the option 82 DHCP message as “replace”.
<b>ip dhcp relay information option subscriber-id {standard   &lt;circuit-id&gt;}</b> <b>no ip dhcp relay information option subscriber-id</b>	This command is used to set the format of option 82 sub-option1(Circuit ID option) added to the DHCP request messages from interface, standard means the standard VLAN name and physical port name format, like“Vlan2+Ethernet1/12”,<circuit-id> is the circuit-id contents of option 82 specified by users, which is a string no longer than 64characters. The” <b>no ip dhcp relay information option subscriber-id</b> ” command will set the format of added option 82 sub-option1 (Circuit ID option) as standard format.

<b>ip dhcp relay information option remote-id {standard   &lt;remote-id&gt;}</b> <b>no ip dhcp relay information option remote-id</b>	Set the suboption2 (remote ID option) content of option 82 added by DHCP request packets (They are received by the interface). The no command sets the additive suboption2 (remote ID option) format of option 82 as standard.
--	--

3. Enable the DHCP option 82 of server.

Command	Explanation
Global mode	
<b>ip dhcp server relay information enable</b> <b>no ip dhcp server relay information enable</b>	This command is used to enable the switch DHCP server to identify option82. The “no ip dhcp server relay information enable” command will make the server ignore the option 82.

4. Configure DHCP option 82 default format of Relay Agent

Command	Explanation
Global mode	
<b>ip dhcp relay information option subscriber-id format {hex   acsii   vs-hp}</b>	Set subscriber-id format of Relay Agent option82.
<b>ip dhcp relay information option remote-id format {default   vs-hp}</b>	Set remote-id format of Relay Agent option82.

5. Configure delimiter

Command	Explanation
Global mode	
<b>ip dhcp relay information option delimiter [colon   dot   slash   space]</b> <b>no ip dhcp relay information option delimiter</b>	Set the delimiter of each parameter for suboption of option82 in global mode, no command restores the delimiter as slash.

6. Configure creation method of option82

Command	Explanation
Global mode	
<b>ip dhcp relay information option self-defined remote-id {hostname   mac   string WORD}</b> <b>no ip dhcp relay information option self-defined remote-id</b>	Set creation method for option82, users can define the parameters of remote-id suboption by themselves
<b>ip dhcp relay information option self-defined remote-id format [ascii   hex]</b>	Set self-defined format of remote-id for relay option82.
<b>ip dhcp relay information option self-defined subscriber-id {vlan   port   id (switch-id (mac   hostname)  remote-mac)  string WORD }</b> <b>no ip dhcp relay information option self-defined subscriber-id</b>	Set creation method for option82, users can define the parameters of circuit-id suboption by themselves
<b>ip dhcp relay information option self-defined subscriber-id format [ascii   hex]</b>	Set self-defined format of circuit-id for relay option82.

7. Diagnose and maintain DHCP option 82

Command	Explanation
Admin mode	
<b>show ip dhcp relay information option</b>	This command will display the state information of the DHCP option 82 in the system, including option82 enabling switch, the interface retransmitting policy, the circuit ID mode and the DHCP server option82 enabling switch.
<b>debug ip dhcp relay packet</b>	This command is used to display the information of data packets processing in DHCP Relay Agent, including the “add” and “peel” action of option 82.



## 31.3 DHCP option 82 Application Examples

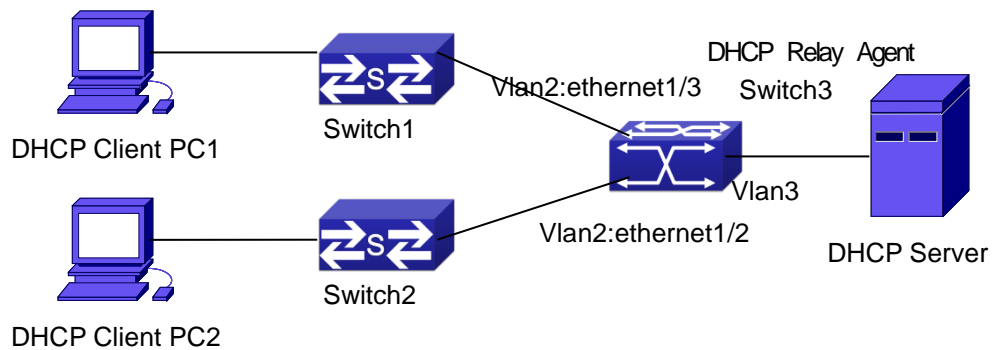

**Figure 31-1** A DHCP option 82 typical application example

In the above example, layer 2 switches Switch1 and Switch2 are both connected to layer 3 switch Switch3, Switch 3 will transmit the request message from DHCP client to DHCP server as DHCP Relay Agent. It will also transmit the reply message from the server to DHCP client to finish the DHCP protocol procedure. If the DHCP option 82 is disabled, DHCP server cannot distinguish that whether the DHCP client is from the network connected to Switch1 or Switch2. So, all the PC terminals connected to Switch1 and Switch2 will get addresses from the public address pool of the DHCP server. After the DHCP option 82 function is enabled, since the Switch3 appends the port information of accessing Switch3 to the request message from the client, the server can tell that whether the client is from the network of Switch1 or Switch2, and thus can allocate separate address spaces for the two networks, to simplify the management of networks.

The following is the configuration of Switch3(MAC address is 00:03:4f:02:33:01):

```
Switch3(Config)#service dhcp
Switch3(Config)#ip dhcp relay information option
Switch3(Config)#ip forward-protocol udp bootps
Switch3(Config)#interface vlan 3
Switch3(Config-if-vlan3)#ip address 192.168.10.222 255.255.255.0
Switch3(Config-if-vlan2)#ip address 192.168.102.2 255.255.255.0
Switch3(Config-if-vlan2)#ip helper 192.168.10.88
```

Linux ISC DHCP Server supports option 82, its configuration file /etc/dhcpd.conf is ddns-update-style interim;

```
ignore client-updates;

class "Switch3Vlan2Class1" {
match if option agent.circuit-id = "Vlan2+Ethernet1/0/2" and option agent.remote-id=00:03:4f:02:33:01;
}

class "Switch3Vlan2Class2" {
match if option agent.circuit-id = "Vlan2+Ethernet1/0/3" and option agent.remote-id=00:03:4f:02:33:01;
}

subnet 192.168.102.0 netmask 255.255.255.0 {
option routers 192.168.102.2;
option subnet-mask 255.255.255.0;
option domain-name "example.com.cn";
option domain-name-servers 192.168.10.3;
authoritative;

pool {
range 192.168.102.21 192.168.102.50;
default-lease-time 86400; #24 Hours
max-lease-time 172800; #48 Hours
allow members of "Switch3Vlan2Class1";
}
pool {
range 192.168.102.51 192.168.102.80;
default-lease-time 43200; #12 Hours
max-lease-time 86400; #24 Hours
allow members of "Switch3Vlan2Class2";
}
}
```

Now, the DHCP server will allocate addresses for the network nodes from Switch1 which are relayed by Switch3 within the range of 192.168.102.21 ~ 192.168.102.50, and allocate addresses for the network nodes from Switch1 within the range of 192.168.102.51 ~ 192.168.102.80.

## 31.4 DHCP option 82 Troubleshooting

- DHCP option 82 is implemented as a sub-function module of DHCP Relay Agent. Before using it, users should make sure that the DHCP Relay Agent is configured correctly.
- DHCP option 82 needs the DHCP Relay Agent and the DHCP server cooperate to finish the task of allocating IP addresses. The DHCP server should set allocating policy correctly depending on the network topology of the DHCP Relay Agent, or, even the Relay Agent can operate normally, the allocation of addresses will fail. When there is more than one kind of Relay Agent, please pay attention to the retransmitting policy of the interface DHCP request messages.

- 
- To implement the option 82 function of DHCP Relay Agent, the “debug dhcp relay packet” command can be used during the operating procedure, including adding the contents of option 82, the retransmitting policy adopted, the option 82 contents of the server peeled by the Relay Agent and etc., such information can help users to do troubleshooting.
  - To implement the option 82 function of DHCP server, the “debug ip dhcp server packet” command can be used during the operating procedure to display the procedure of data packets processing of the server, including displaying the identified option 82 information of the request message and the option 82 information returned by the reply message.

---

# Chapter 32 DHCPv6 option37, 38

## 32.1 Introduction to DHCPv6 option37, 38

DHCPv6 (Dynamic Host Configuration Protocol for IPv6) is designed for IPv6 address scheme and is used for assigning IPv6 prefixes, IPv6 addresses and other configuration parameters to hosts.

When DHCPv6 client wants to request address and configure parameter of DHCPv6 server from different link, it needs to communicate with server through DHCPv6 relay agent. DHCPv6 message received by relay agent node is reencapsulated to be relay-forward packets and they are forwarded to the server which sends the relay-reply packets to DHCPv6 relay agent node in different link, after that, relay agent node restores DHCPv6 message to DHCPv6 client to finish communication between client and server.

There are some problems when using DHCPv6 relay agent, for example: How to assign IP address in the fixed range to the specific users? How to avoid illegal DHCPv6 client to forge IP address exhaust attack triggered by MAC address fields of DHCPv6 packets? How to avoid illegal DHCPv6 client to trigger deny service attack through using MAC address of other legal clients? Therefore, IETF set rfc4649 and rfc4580, i.e. DHCPv6 option 37 and option 38 to solve these problems.

DHCPv6 option 37 and option 38 is similar to DHCP option 82. When DHCPv6 client sends request packets to DHCPv6 server though DHCPv6 relay agent, if DHCPv6 relay agent supports option 37 and option 38, they will be added to request packets. For the respond packets of server, option 37 and option 38 are meaningless and are peeled from the respond packets. Therefore, the application of option 37 and option 38 is transparent for client.

DHCPv6 server can authenticate identity of DHCPv6 client and DHCPv6 relay device by option 37 and option 38, assign and manage client address neatly through configuring the assign policy, prevent DHCPv6 attack availably according to the inclusive client information, such as forging MAC address fields of DHCPv6 packets to trigger IP address exhaust attack. Since server can identify multiple request packets from the same access port, it can assign the address number through policy limit to avoid address exhaust. However, rfc4649 and rfc4580 do not set how to use option 37 and option 38 for DHCPv6 server, users can use it neatly according to their own demand.

## 32.2 DHCPv6 option37, 38 Configuration Task List

1. DHCPv6 snooping option basic functions configuration
2. DHCPv6 relay option basic functions configuration
3. DHCPv6 server option basic functions configuration

1. DHCPv6 snooping option basic functions configuration

Command	Explanation
Global mode	

<p><b>ipv6 dhcp snooping remote-id option</b>  <b>no ipv6 dhcp snooping remote-id option</b></p>	<p>This command enables DHCPv6 SNOOPING to support option 37 option, no command disables it.</p>
<p><b>ipv6 dhcp snooping subscriber-id option</b>  <b>no ipv6 dhcp snooping subscriber-id option</b></p>	<p>This command enables DHCPv6 SNOOPING to support option 38 option, no command disables it.</p>
<p><b>ipv6 dhcp snooping remote-id policy</b>  <b>{drop   keep   replace}</b>  <b>no ipv6 dhcp snooping remote-id policy</b></p>	<p>This command is used to configure the reforward policy of the system when receiving DHCPv6 packets with option 37, which can be:</p> <p><b>drop</b>, the system simply discards it with option 37;</p> <p><b>keep</b>, the system keeps option 37 unchanged and forwards the packet to the server;</p> <p><b>replace</b>, the system replaces option 37 of current packet with its own before forwarding it to the server. no command configures the reforward policy of DHCPv6 packets with option 37 as replace.</p>
<p><b>ipv6 dhcp snooping subscriber-id policy</b>  <b>{drop   keep   replace}</b>  <b>no ipv6 dhcp snooping subscriber-id policy</b></p>	<p>This command is used to configure the reforward policy of the system when receiving DHCPv6 packets with option 38, which can be:</p> <p><b>drop</b>, the system simply discards it with option 38;</p> <p><b>keep</b>, the system keeps option 38 unchanged and forwards the packet to the server;</p> <p><b>replace</b>, the system replaces option 38 of current packet with its own before forwarding it to the server. no command configures the reforward policy of DHCPv6 packets with option 38 as replace.</p>

<b>ipv6 dhcp snooping subscriber-id select</b> <b>(sp   sv   pv   spv) delimiter WORD</b> <b>(delimiter WORD )</b> <b>no ipv6 dhcp snooping subscriber-id</b> <b>select delimiter</b>	Configures user configuration options to generate subscriber-id, no command restores to its original default configuration, i.e. enterprise number together with vlan MAC.
<b>ipv6 dhcp snooping subscriber-id select</b> <b>(sp sv pv spv) delimiter WORD</b> <b>(delimiter WORD )</b> <b>no ipv6 dhcp snooping subscriber-id</b> <b>select delimiter</b>	Configures user configuration options to generate subscriber-id. The no command restores to its original default configuration, i.e. vlan name together with port name.
Port mode	
<b>ipv6 dhcp snooping remote-id</b> <b>&lt;remote-id&gt;</b> <b>no ipv6 dhcp snooping remote-id</b>	This command is used to set the form of adding option 37 in received DHCPv6 request packets, of which <remote-id> is the content of remote-id in user-defined option 37 and it is a string with a length of less than 128. The no operation restores remote-id in option 37 to enterprise-number together with vlan MAC address.
<b>ipv6 dhcp snooping subscriber-id</b> <b>&lt;subscriber-id&gt;</b> <b>no ipv6 dhcp snooping subscriber-id</b>	This command is used to set the form of adding option 38 in received DHCPv6 request packets, of which <subscriber-id> is the content of subscriber-id in user-defined option 38 and it is a string with a length of less than 128. The no operation restores subscriber-id in option 38 to vlan name together with port name such as "Vlan2+Ethernet1/0/2".

## 2. DHCPv6 relay option basic functions configuration

Command	Explanation
Global mode	
<b>ipv6 dhcp relay remote-id option</b> <b>no ipv6 dhcp relay remote-id option</b>	This command enables the switch relay to support option 37 and the no form of this command disables it.
<b>ipv6 dhcp relay subscriber-id option</b> <b>no ipv6 dhcp relay subscriber-id option</b>	This command enables the switch relay to support the option 38, the no form of this command disables it.

<b>ipv6 dhcp relay remote-id delimiter</b> <b>WORD</b> <b>no ipv6 dhcp relay remote-id delimiter</b>	Configures user configuration options to generate remote-id. The no command restores to its original default configuration, i.e. enterprise number together with vlan MAC.
<b>ipv6 dhcp relay subscriber-id select (sp   sv   pv   spv) delimiter WORD (delimiter WORD )</b> <b>no ipv6 dhcp relay subscriber-id select delimiter</b>	Configures user configuration options to generate subscriber-id. The no command restores to its original default configuration, i.e. vlan name together with port name.
Layer3 Interface configuration mode	
<b>ipv6 dhcp relay remote-id &lt;remote-id&gt;</b> <b>no ipv6 dhcp relay remote-id</b>	This command is used to set the form of adding option 37 in received DHCPv6 request packets, of which <remote-id> is the content of remote-id in user-defined option 37 and it is a string with a length of less than 128. The no operation restores remote-id in option 37 to enterprise-number together with vlan MAC address.
<b>ipv6 dhcp relay subscriber-id &lt;subscriber-id&gt;</b> <b>no ipv6 dhcp relay subscriber-id</b>	This command is used to set the form of adding option 38 in received DHCPv6 request packets, of which <subscriber-id> is the content of subscriber-id in user-defined option 38 and it is a string with a length of less than 128. The no operation restores subscriber-id in option 38 to vlan name together with port name such as "Vlan2+Ethernet1/0".

### 3. DHCPv6 server option basic functions configuration

<b>Command</b>	<b>Explanation</b>
Global mode	
<b>ipv6 dhcp server remote-id option</b> <b>no ipv6 dhcp server remote-id option</b>	This command enables DHCPv6 server to support the identification of option 37, the no form of this command disables it.
<b>ipv6 dhcp server subscriber-id option</b> <b>no ipv6 dhcp server subscriber-id option</b>	This command enables DHCPv6 server to support the identification of option 38, the no form of this command disables it.

<b>ipv6 dhcp use class</b> <b>no ipv6 dhcp use class</b>	<p>This command enables DHCPv6 server to support the using of DHCPv6 class during address assignment, the no form of this command disables it without removing the relative DHCPv6 class information that has been configured.</p>
<b>ipv6 dhcp class &lt;class-name&gt;</b> <b>no ipv6 dhcp class &lt;class-name&gt;</b>	<p>This command defines a DHCPv6 class and enters DHCPv6 class mode, the no form of this command removes this DHCPv6 class.</p>
Interface configuration mode	
<b>ipv6 dhcp server select relay-forw</b> <b>no ipv6 dhcp server select relay-forw</b>	<p>This command enables the DHCPv6 server to support selections when multiple option 37 or option 38 options exist and the option 37 and option 38 of relay-forw in the innermost layer are selected. The no operation of it restores the default configuration, i.e. selecting option 37 and option 38 of the original packets.</p>
IPv6 DHCP Class configuration mode	
<b>{remote-id [*] &lt;remote-id&gt; [*]  </b> <b>subscriber-id [*] &lt;subscriber-id&gt; [*]}</b> <b>no {remote-id [*] &lt;remote-id&gt; [*]  </b> <b>subscriber-id [*] &lt;subscriber-id&gt; [*]}</b>	<p>This command configures option 37 and option 38 that match the class in ipv6 dhcp class configuration mode.</p>
DHCPv6 address pool configuration mode	
<b>class &lt;class-name&gt;</b> <b>no class &lt;class-name&gt;</b>	<p>This command associates class to address pool in DHCPv6 address pool configuration mode and enters class configuration mode in address pool. Use no command to remove the link.</p>
<b>address range &lt;start-ip&gt; &lt;end-ip&gt;</b> <b>no address range &lt;start-ip&gt; &lt;end-ip&gt;</b>	<p>This command is used to set address range for a DHCPv6 class in DHCPv6 address pool configuration mode, the no command is used to remove the address range. The prefix/plan form is not supported.</p>



## 32.3 DHCPv6 option37, 38 Examples

### 32.3.1 DHCPv6 Snooping option37, 38 Example

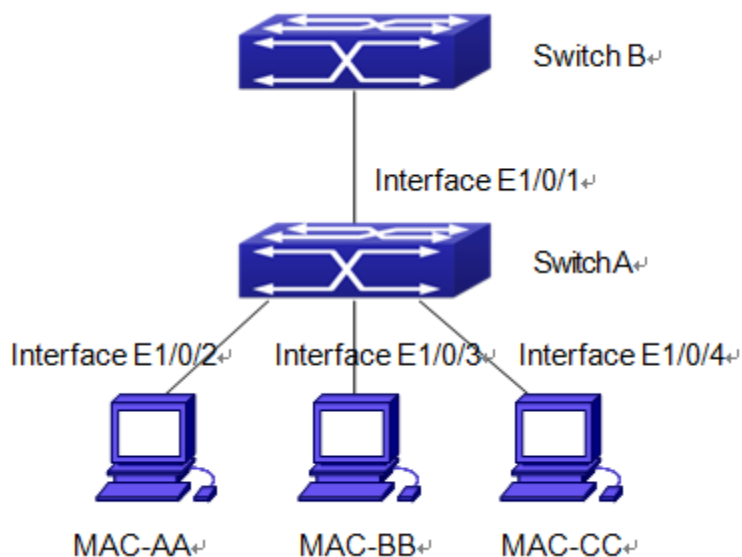

**Figure 32-1** DHCPv6 Snooping option schematic

As is shown in the figure above, Mac-AA, Mac-BB and Mac-CC are normal users, connected to entrusted interface 1/2, 1/3 and 1/4 respectively, and they get IP 2010:2, 2010:3 and 2010:4 through DHCPv6 Client; DHCPv6 Server is connected to the trusted interface 1/1. Configure three address assignment policies (CLASS), of which CLASS1 matches option 38, CLASS2 matches option 37 and CLASS3 matches option 37 and option 38. In the address pool EastDormPool, the requests matched with CLASS1, CLASS2 and CLASS3 will be assigned an address ranging from 2001:da8:100:1::2 to 2001:da8:100:1::30, from 2001:da8:100:1::31 to 2001:da8:100:1::60 and from 2001:da8:100:1::61 to 2001:da8:100:1::100 respectively; DHCPv6 snooping function is enabled and option 37 and option 38 are configured in Switch A.

Switch A configuration:

```
SwitchA(config)#ipv6 dhcp snooping remote-id option
SwitchA(config)#ipv6 dhcp snooping subscriber-id option
SwitchA(config)#int e 1/0/1
SwitchA(config-if-ethernet1/0/1)#ipv6 dhcp snooping trust
SwitchA(config-if-ethernet1/0/1)#exit
SwitchA(config)#interface vlan 1

SwitchA(config-if-vlan1)#ipv6 address 2001:da8:100:1::1
SwitchA(config-if-vlan1)#exit
SwitchA(config)#interface ethernet 1/0/1-4
SwitchA(config-if-port-range)#switchport access vlan 1
SwitchA(config-if-port-range)#exit
SwitchA(config)#
```

---

Switch B configuration:

```
SwitchB(config)#service dhcpv6
SwitchB(config)#ipv6 dhcp server remote-id option
SwitchB(config)#ipv6 dhcp server subscriber-id option
SwitchB(config)#ipv6 dhcp pool EastDormPool
SwitchB(dhcpv6-eastdormpool-config)#network-address 2001:da8:100:1::2 2001:da8:100:1::1000
SwitchB(dhcpv6-eastdormpool-config)#dns-server 2001::1
SwitchB(dhcpv6-eastdormpool-config)#domain-name dhcpv6.com
SwitchB(dhcpv6-eastdormpool-config)# excluded-address 2001:da8:100:1::2
SwitchB(dhcpv6-eastdormpool-config)#exit
SwitchB(config)#
SwitchB(config)#ipv6 dhcp class CLASS1
SwitchB(dhcpv6-class-class1-config)#remote-id 00-03-0f-00-00-01 subscriber-id vlan1+Ethernet1/0/1
SwitchB(dhcpv6-class-class1-config)#exit
SwitchB(config)#ipv6 dhcp class CLASS2
SwitchB(dhcpv6-class-class2-config)#remote-id 00-03-0f-00-00-01 subscriber-id vlan1+Ethernet1/0/2
SwitchB(dhcpv6-class-class2-config)#exit
SwitchB(config)#ipv6 dhcp class CLASS3
SwitchB(dhcpv6-class-class3-config)#remote-id 00-03-0f-00-00-01 subscriber-id vlan1+Ethernet1/0/3
SwitchB(dhcpv6-class-class3-config)#exit
SwitchB(config)#ipv6 dhcp pool EastDormPool
SwitchB(dhcpv6-eastdormpool-config)#class CLASS1
SwitchB(dhcpv6-pool-eastdormpool-class-class1-config)#address range 2001:da8:100:1::3
2001:da8:100:1::30
SwitchB(dhcpv6-pool-eastdormpool-class-class1-config)#exit
SwitchB(dhcpv6-eastdormpool-config)#class CLASS2
SwitchB(dhcpv6-pool-eastdormpool-class-class2-config)#address range 2001:da8:100:1::31
2001:da8:100:1::60
SwitchB(dhcpv6-eastdormpool-config)#class CLASS3
SwitchB(dhcpv6-pool-eastdormpool-class-class3-config)#address range 2001:da8:100:1::61
2001:da8:100:1::100
SwitchB(dhcpv6-pool-eastdormpool-class-class3-config)#exit
SwitchB(dhcpv6-eastdormpool-config)#exit
SwitchB(config)#interface vlan 1
SwitchB(config-if-vlan1)#ipv6 address 2001:da8:100:1::2/64
SwitchB(config-if-vlan1)#ipv6 dhcp server EastDormPool
SwitchB(config-if-vlan1)#exit
SwitchB(config)#
```

### 32.3.2 DHCPv6 Snooping option37, 38 Example

#### Example 1 :

When deploying IPv6 campus network, DHCPv6 server function of routing device can be used for IPv6 address allocation if special server is used for uniform allocation and management for IPv6 address. DHCPv6

server supports both tasteful and stateless DHCPv6.

### Network topology:

In access layer, layer2 access device Switch1 connects users in dormitory; in first-level aggregation layer, aggregation device Switch2 is used as DHCPv6 relay agent; in second-level aggregation layer, aggregation device Switch3 is used as DHCPv6 server and connects with backbone network or devices in higher aggregation layer; in user side, PCs are generally loaded with Windows Vista system, thus having DHCPv6 client.

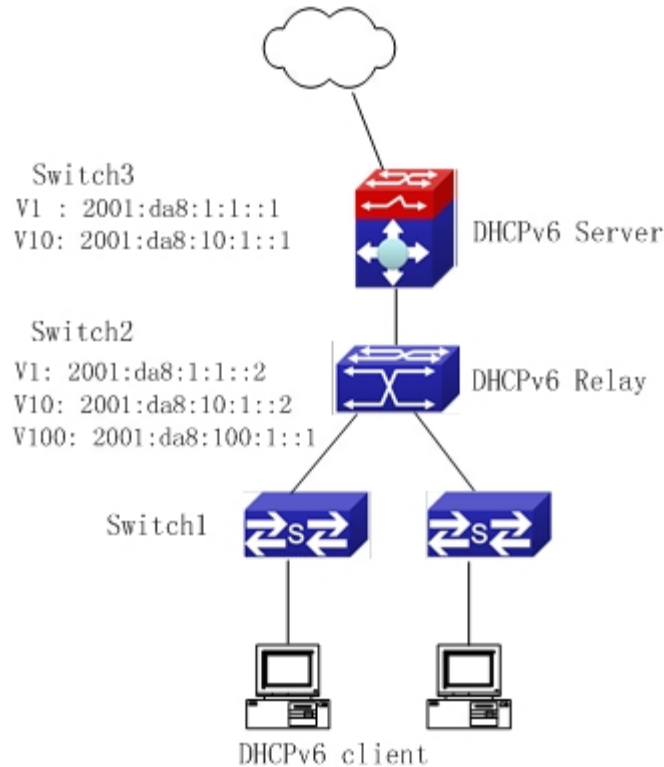

Figure 32-2 DHCPv6 relay option schematic

Switch2 configuration:

```
S2(config)#service dhcpv6
S2(config)#ipv6 dhcp relay remote-id option
S2(config)#ipv6 dhcp relay subscriber-id option
S2(config)#vlan 10
S2(config-vlan10)#int vlan 10
S2(config-if-vlan10)#ipv6 address 2001:da8:1::2/64
S2(config-if-vlan10)#ipv6 dhcp relay destination 2001:da8:10:1::1
S2(config-if-vlan10)#exit
S2(config)#
```

## 32.4 DHCPv6 option37, 38 Troubleshooting

- Request packets sent by DHCPv6 client are multicast packets received by the device within its VLAN, if DHCPv6 server wants to receive the packets from client, DHCPv6 client and DHCPv6 server must be in the same VLAN, otherwise it needs to use DHCPv6 relay.

- 
- Snooping option37,38 can process one of the following operations for DHCPv6 request packets with option37,38: replace the original option37,38 with its own; discard the packets with option37,38; do not execute adding, discarding or forwarding operation. Therefore, please check policy configuration of snooping option37,38 on second device when obtaining the false address or no address is obtained according to option37,38.
  - DHCPv6 server obtains option37,38 of the packets from client by default, if no, it will obtain option37,38 of the packet sent by relay.
  - DHCPv6 server only checks whether the first DHCPv6 relay adds option37,38 that means only option37,38 of the innermost relay-forw is valid in relay packets.

---

# Chapter 33 DHCP Snooping Configuration

## 33.1 Introduction to DHCP Snooping

DHCP Snooping means that the switch monitors the IP-getting process of DHCP CLIENT via DHCP protocol. It prevents DHCP attacks and illegal DHCP SERVER by setting trust ports and untrust ports. And the DHCP messages from trust ports can be forwarded without being verified. In typical settings, trust ports are used to connect DHCP SERVER or DHCP RELAY Proxy, and untrust ports are used to connect DHCP CLINET. The switch will forward the DHCP request messages from untrust ports, but not DHCP reply ones. If any DHCP reply messages is received from a untrust port, besides giving an alarm, the switch will also implement designated actions on the port according to settings, such as “shutdown”, or distributing a “blackhole”. If DHCP Snooping binding is enabled, the switch will save binding information (including its MAC address, IP address, IP lease, VLAN number and port number) of each DHCP CLINET on untrust ports in DHCP snooping binding table. With such information, DHCP Snooping can combine modules like dot1x and ARP, or implement user-access-control independently.

**Defense against Fake DHCP Server:** once the switch intercepts the DHCP Server reply packets ( including DHCP OFFER, DHCPACK, and DHCPNAK ) , it will alarm and respond according to the situation ( shutdown the port or send Black hole ) .

**Defense against DHCP over load attacks:** To avoid too many DHCP messages attacking CPU, users should limit the DHCP speed of receiving packets on trusted and non-trusted ports.

**Record the binding data of DHCP:** DHCP SNOOPING will record the binding data allocated by DHCP SERVER while forwarding DHCP messages, it can also upload the binding data to the specified server to backup it. The binding data is mainly used to configure the dynamic users of dot1x user based ports. Please refer to the chapter called “dot1x configuration” to find more about the usage of dot1x use-based mode.

**Add binding ARP:** DHCP SNOOPING can add static binding ARP according to the binding data after capturing binding data, thus to avoid ARP cheating.

**Add trusted users:** DHCP SNOOPING can add trusted user list entries according to the parameters in binding data after capturing binding data; thus these users can access all resources without DOT1X authentication.

**Automatic Recovery:** A while after the switch shut down the port or send blockhole, it should automatically recover the communication of the port or source MAC and send information to Log Server via syslog.

**LOG Function:** When the switch discovers abnormal received packets or automatically recovers, it should send syslog information to Log Server.

**The Encryption of Private Messages:** The communication between the switch and the inner network security management system TrustView uses private messages. And the users can encrypt those messages of version 2.

**Add authentication option82 Function:** It is used with dot1x dhcption82 authentication mode. Different option 82 will be added in DHCP messages according to user’s authentication status.

---

## 33.2 DHCP Snooping Configuration Task Sequence

1. Enable DHCP Snooping
2. Enable DHCP Snooping binding function
3. Enable DHCP Snooping binding ARP function
4. Enable DHCP Snooping option82 function
5. Set the private packet version
6. Set DES encrypted key for private packets
7. Set helper server address
8. Set trusted ports
9. Enable DHCP Snooping binding DOT1X function
10. Enable DHCP Snooping binding USER function
11. Adding static list entries function
12. Set defense actions
13. Set rate limitation of DHCP messages
14. Enable the debug switch
15. Configure DHCP Snooping option 82 attributes

### 1 · Enable DHCP Snooping

Command	Explanation
Globe mode	
<b>ip dhcp snooping enable</b> <b>no ip dhcp snooping enable</b>	Enable or disable the DHCP snooping function.

### 2 · Enable DHCP Snooping binding

Command	Explanation
Globe mode	
<b>ip dhcp snooping binding enable</b> <b>no ip dhcp snooping binding enable</b>	Enable or disable the DHCP snooping binding function.

### 3 · Enable DHCP Snooping binding ARP function

Command	Explanation
Globe mode	
<b>ip dhcp snooping binding arp</b> <b>no ip dhcp snooping binding arp</b>	Enable or disable the dhcp snooping binding ARP function.

---

#### 4 · Enable DHCP Snooping option82 function

Command	Explanation
Globe mode	
<b>ip dhcp snooping information enable</b> <b>no ip dhcp snooping information enable</b>	Enable/disable DHCP Snooping option 82 function.

#### 5 · Set the private packet version

Command	Explanation
Globe mode	
<b>ip user private packet version two</b> <b>no ip user private packet version two</b>	To configure/delete the private packet version.

#### 6 · Set DES encrypted key for private packets

Command	Explanation
Globe mode	
<b>enable trustview key 0/7 &lt;password&gt;</b> <b>no enable trustview key</b>	To configure/delete DES encrypted key for private packets.

#### 7 · Set helper server address

Command	Explanation
Globe mode	
<b>ip user helper-address A.B.C.D</b> <b>[port &lt;udpport&gt;] source &lt;ipAddr&gt;</b> <b>(secondary)</b> <b>no ip user helper-address</b> <b>(secondary)</b>	Set or delete helper server address.

#### 8 · Set trusted ports

Command	Explanation
Port mode	
<b>ip dhcp snooping trust</b> <b>no ip dhcp snooping trust</b>	Set or delete the DHCP snooping trust attributes of ports.

#### 9 · Enable DHCP SNOOPING binding DOT1X function

Command	Explanation
Port mode	
<b>ip dhcp snooping binding dot1x</b> <b>no ip dhcp snooping binding dot1x</b>	Enable or disable the DHCP snooping binding dot1x function.

10 · Enable or disable the DHCP SNOOPING binding USER function

Command	Explanation
Port mode	
<b>ip dhcp snooping binding user-control</b> <b>no ip dhcp snooping binding user-control</b>	Enable or disable the DHCP snooping binding user function.

11 · Add static binding information

Command	Explanation
Globe mode	
<b>ip dhcp snooping binding user &lt;mac&gt; address &lt;ipAddr&gt; &lt;mask&gt; vlan &lt;vid&gt; interface (ethernet!) &lt;ifname&gt;</b> <b>no ip dhcp snooping binding user &lt;mac&gt; interface (ethernet!) &lt;ifname&gt;</b>	Add/delete DHCP snooping static binding list entries.

12 · Set defense actions

Command	Explanation
Port mode	
<b>ip dhcp snooping action {shutdown blackhole} [recovery &lt;second&gt;]</b> <b>no ip dhcp snooping action</b>	Set or delete the DHCP snooping automatic defense actions of ports.

13 · Set rate limitation of data transmission

Command	Explanation
Globe mode	
<b>ip dhcp snooping limit-rate &lt;pps&gt;</b> <b>no ip dhcp snooping limit-rate</b>	Set rate limitation of the transmission of DHCP snooping messages.

14 · Enable the debug switch

Command	Explanation
Admin mode	
<b>debug ip dhcp snooping packet</b> <b>debug ip dhcp snooping event</b> <b>debug ip dhcp snooping update</b> <b>debug ip dhcp snooping binding</b>	Please refer to the chapter on system troubleshooting.



15 · Configure DHCP Snooping option 82 attributes

Command	Explanation
Globe mode	
<b>ip dhcp snooping information option subscriber-id format {hex   acsii   vs-hp}</b>	This command is used to set subscriber-id format of DHCP snooping option82.
<b>ip dhcp snooping information option remote-id {standard   &lt;remote-id&gt;} no ip dhcp snooping information option remote-id</b>	Set the suboption2 (remote ID option) content of option 82 added by DHCP request packets (they are received by the port). The no command sets the additive suboption2 (remote ID option) format of option 82 as standard.
<b>ip dhcp snooping information option allow-untrusted no ip dhcp snooping information option allow-untrusted</b>	This command is used to set that allow untrusted ports of DHCP snooping to receive DHCP packets with option82 option. When disabling this command, all untrusted ports will drop DHCP packets with option82 option.
<b>ip dhcp snooping information option delimiter [colon   dot   slash   space] no ip dhcp snooping information option delimiter</b>	Set the delimiter of each parameter for suboption of option82 in global mode, no command restores the delimiter as slash.
<b>ip dhcp snooping information option self-defined remote-id {hostname   mac   string WORD} no ip dhcp snooping information option self-defined remote-id</b>	Set creation method for option82, users can define the parameters of remote-id suboption by themselves.
<b>ip dhcp snooping information option self-defined remote-id format [ascii   hex]</b>	Set self-defined format of remote-id for snooping option82.
<b>ip dhcp snooping information option self-defined subscriber-id {vlan   port   id (switch-id (mac   hostname)  remote-mac)   string WORD} no ip dhcp snooping information option type self-defined subscriber-id</b>	Set creation method for option82, users can define the parameters of circute-id suboption by themselves.
<b>ip dhcp snooping information option self-defined subscriber-id format [ascii   hex]</b>	Set self-defined format of circuit-id for snooping option82.

Port mode	
<b>ip dhcp snooping information option subscriber-id {standard   &lt;circuit-id&gt;}</b>	Set the suboption1 (circuit ID option) content of option 82 added by DHCP request packets (they are received by the port). The no command sets the additive suboption1 (circuit ID option) format of option 82 as standard.
<b>no ip dhcp snooping information option subscriber-id</b>	

### 33.3 DHCP Snooping Typical Application

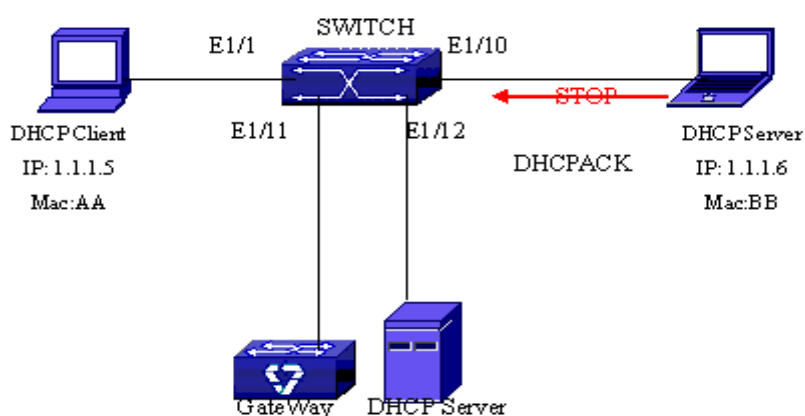

**Figure 33-1** Sketch Map of TRUNK

As showed in the above chart, Mac-AA device is the normal user, connected to the non-trusted port 1/1 of the switch. It operates via DHCP Client, IP 1.1.1.5; DHCP Server and GateWay are connected to the trusted ports 1/11 and 1/12 of the switch; the malicious user Mac-BB is connected to the non-trusted port 1/10, trying to fake a DHCP Server ( by sending DHCPACK ) . Setting DHCP Snooping on the switch will effectively detect and block this kind of network attack.

Configuration sequence is:

```

switch#
switch#config
switch(config)#ip dhcp snooping enable
switch(config)#interface ethernet 1/0/11
switch(Config-If-Ethernet1/0/11)#ip dhcp snooping trust
switch(Config-If-Ethernet1/0/11)#exit
switch(config)#interface ethernet 1/0/12
switch(Config-If-Ethernet1/0/12)#ip dhcp snooping trust
switch(Config-If-Ethernet1/0/12)#exit
switch(config)#interface ethernet 1/0/1-10
switch(Config-Port-Range)#ip dhcp snooping action shutdown
switch(Config-Port-Range)#

```

---

## 33.4 DHCP Snooping Troubleshooting Help

### 33.4.1 Monitor and Debug Information

The “debug ip dhcp snooping” command can be used to monitor the debug information.

### 33.4.2 DHCP Snooping Troubleshooting Help

If there is any problem happens when using DHCP Snooping function, please check if the problem is caused by the following reasons:

- Check that whether the global DHCP Snooping is enabled;
- If the port does not react to invalid DHCP Server packets, please check that whether the port is set as a non-trusted port of DHCP Snooping.

## 33.5 DHCPv6 Snooping Typical Application

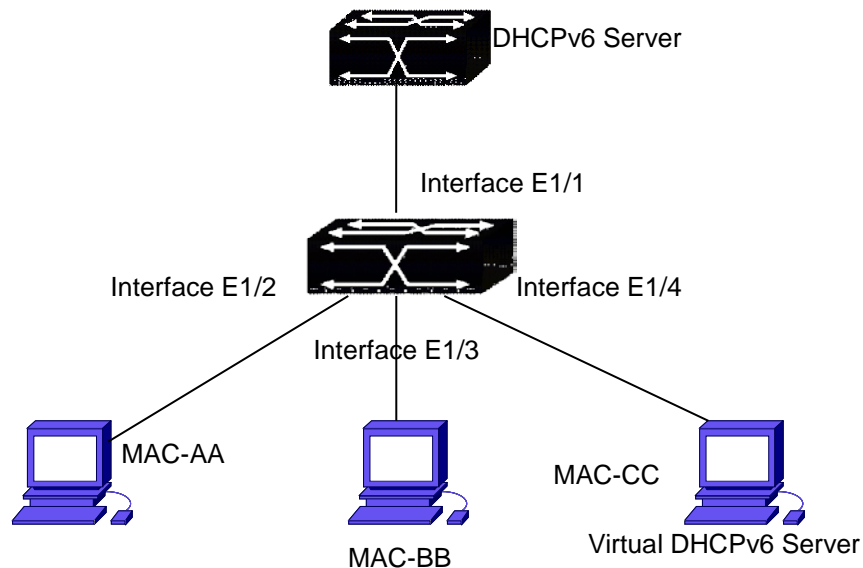

**Figure 4-1** Sketch Map of preventing lawless DHCPv6 Server

As showed in the above chart, MAC-AA and MAC-BB devices are normal users, they are connected to the non-trusted ports 1/2 and 1/3 of the switch, and obtain IP 2010::3 and IP 2010::4 through DHCPv6 Client; DHCPv6 Server are connected to the trust port 1/1 of the switch; the malicious user Mac-CC is connected to the non-trusted port 1/4, it tries to fake DHCPv6 Server. Setting DHCPv6 Snooping on the switch will effectively detect and prevent this kind of network attack.

Configuration sequence is:

```
switch#
switch#config
switch(config)#ipv6 dhcp snooping enable
switch(config)#ipv6 dhcp snooping binding enable
switch(config)#interface ethernet 1/1
switch(Config-Ethernet 1/1)#ipv6 dhcp snooping trust
switch(Config-Ethernet1/1)#exit
switch(config)#interface ethernet 1/4-10
switch(Config-Port-Range)#ipv6 dhcp snooping action shutdown
switch(Config-Port-Range)#
```

---

## 33.6 DHCPv6 Snooping Troubleshooting

### 33.6.1 Monitor and Debug Information

The “debug ipv6 dhcp snooping” command can be used to monitor the debug information.

### 33.6.2 DHCPv6 Snooping Troubleshooting Help

If there is any problem happens when using DHCPv6 Snooping function, please check whether the problem is caused by the following reasons:

- Check whether the DHCPv6 Snooping is enabled globally;
- If DHCP client does not obtain IP when configuring DHCPv6 Snooping, please check whether the port connected by DHCPv6 server/relay is set as a trust port.

---

# Chapter 34 Routing Protocol Overview

To communicate with a remote host over the Internet, a host must choose a proper route via a set of routers or Layer3 switches.

Both routers and layer3 switches calculate the route using CPU, the difference is that layer3 switch adds the calculated route to the switch chip and forward by the chip at wire speed, while the router always store the calculated route in the route table or route buffer, and data forwarding is performed by the CPU. For this reason, although both routers and switches can perform route selection, layer3 switches have great advantage over routers in data forwarding. The following describes basic principle and methods used in layer3 switch route selection.

In route selection, the responsibility of each layer3 switch is to select a proper midway route according to the destination of the packet received; and send the packet to the next layer3 switch until the last layer3 switch in the route send the packet to the destination host. A route is the path selected by each layer3 switch to pass the packet to the next layer3 switch. Route can be grouped into direct route, static route and dynamic route.

Direct route refer to the path directly connects to the layer3 switch, and can be obtained with no calculation.

Static route is the manually specified path to a network or a host; static route cannot be changed freely. The advantage of static route is simple and consistent, and it can limit illegal route modification, and is convenient for load balance and route backup. However, as this is set manually, it is not suitable for mid- or large-scale networks for the route in such conditions are too huge and complex.

Dynamic route is the path to a network or a host calculated by the layer3 switch according to the routing protocols enabled. If the next hop layer3 switch in the path is not reachable, layer3 switch will automatically discard the path to that next hop layer3 switch and choose the path through other layer3 switches.

There are two dynamic routing protocols: Interior Gateway Protocol (IGP) and Exterior Gateway protocol (EGP). IGP is the protocol used to calculate the route to a destination inside an autonomous system. IGP supported by switch include RIP and OSPF, RIP and OSRF can be configured according to the requirement. Switch supports running several IGP dynamic routing protocols at the same time. Or, other dynamic routing protocols and static route can be introduced to a dynamic routing protocol, so that multiple routing protocols can be associated.

EGP is used to exchange routing information among different autonomous systems, such as BGP protocol. EGP supported by switch include BGP-4, BGP-4+.

## 34.1 Routing Table

As mentioned before, layer3 switch is mainly used to establish the route from the current layer3 switch to a network or a host, and to forward packets according to the route. Each layer3 switch has its own route table containing all routes used by that switch. Each route entry in the route table specifies the physical port should be used for forwarding packet to reach a destination host or the next hop layer3 switch to the host.

The route table mainly consists of the following:

- Destination address: used to identify the destination address or destination network of an IP packet.
- Network mask: used together with destination address to identify the destination host or the network the layer3 switch resides. Network mask consists of several consecutive binary 1's, and usually in the format of dotted decimal (an address consists of 1 to 4 255's.) When "AND" the destination address with network mask, we can get the network address for the destination host or the network the layer3 switch resides. For example, the network address of a host or the segment the layer3 switch resides with a destination address of 200.1.1.1 and mask 255.255.255.0 is 200.1.1.0.
- Output interface: specify the interface of layer3 switch to forward IP packets.
- IP address of the next layer3 switch (next hop): specify the next layer3 switch the IP packet will pass.
- Route entry priority: There may be several different next hop routes leading to the same destination. Those routes may be discovered by different dynamic routing protocols or static routes manually configured. The entry with the highest priority (smallest value) becomes the current best route. The user can configure several routes of different priority to the same destination; layer3 switch will choose one route for IP packet forwarding according to the priority order.

To prevent too large route table, a default route can be set. Once route table look up fails, the default route will be chosen for forwarding packets.

The table below describes the routing protocols supported by switch and the default route look up priority value.

Routing Protocols or route type	Default priority value
Direct route	0
OSPF	110
Static route	1
RIP	120
OSPF ASE	150
IBGP	200
EBGP	20
Unknown route	255

## 34.2 IP Routing Policy

### 34.2.1 Introduction to Routing Policy

Some policies have to be applied when the router publishing and receiving routing messages so to filter routing messages, such as only receiving or publishing routing messages meets the specified conditions. A routing protocol maybe need redistribute other routing messages found by other protocols such as OSPF so to increase its own routing knowledge; when the router redistributing routing messages from other routing protocols there may be only part of the qualified routing messages is needed, and some properties may have to be configured to suit this protocol.

---

To achieve routing policy, first we have to define the characteristics of the routing messages to be applied with routing policies, namely define a group matching rules. We can configure by different properties in the routing messages such as destination address, the router address publishing the routing messages. The matching rules can be previously configured to be applied in the routing publishing, receiving and distributing policies. Five filters are provided in switch: route-map, acl, as-path, community-list and ip-prefix for use. We will introduce each filter in following sections:

### **1. route-map**

For matching certain properties of the specified routing information and setting some routing prosperities when the conditions are fulfilled.

Route-map is for controlling and changing the routing messages while also controlling the redistribution among routes. A route-map consists of a series of match and set commands in which the match command specifies the conditions required matching, and the set command specifies the actions to be taken when matches. The route-map is also for controlling route publishing among different route process. It can also used on policy routing which select different routes for the messages other than the shortest route.

A group matches and set clauses make up a node. A route-map may consist of several nodes each of which is a unit for matching test. We match among nodes with by sequence-number. Match clauses define matching rules. The matching objects are some properties of routing messages. Different match clause in the same node is “and” relation logically, which means the matching test of a node, will not be passed until conditions in its entire match clause are matched. Set clause specifies actions, namely configure some properties of routing messages after the matching test is passed.

Different nodes in a route-map is an “or” relation logically. The system checks each node of the route-map in turn and once certain node test is passed the route-map test will be passed without taking the next node test.

### **2. access control list(acl)**

ACL (Access Control Lists) is a data packet filter mechanism in the switch. The switch controls the network access and secure the network service by permitting or denying certain data packet transmitting out from or into the network. Users can establish a group of rules by certain messages in the packet, in which each rule to be applied on certain amount of matching messages: permit or deny. The users can apply these rules to the entrance or exit of specified switch, with which data stream in certain direction on certain port would have to follow the specified ACL rules in-and-out the switch. Please refer to chapter “ACL Configuration”.

### **3. Ip-prefix list**

The ip-prefix list acts similarly to acl while more flexible and more understandable. The match object of ip-prefix is the destination address messages field of routing messages when applied in routing messages filtering.

An ip-prefix is identified by prefix list name. Each prefix list may contain multiple items, each of which specifies a matching range of a network prefix type and identifies with a sequence-number which specifies the matching check order of ip-prefix.

In the process of matching, the switch check each items identified by sequence-number in ascending order and the filter will be passed once certain items is matched( without checking rest items)



---

#### 4. Autonomic system path information access-list as-path

The autonomic system path information access-list as-path is only used in BGP. In the BGP routing messages packet there is an autonomic system path field (in which autonomic system path the routing messages passes through is recorded). As-path is specially for specifying matching conditions for autonomic system path field.

As for relevant as-path configurations, please refer to the ip as-path command in BGP configuration.

#### 5. community-list

Community-list is only for BGP. There is a community property field in the BGP routing messages packet for identifying a community. The community list is for specifying matching conditions for Community-list field.

As for relevant Community-list configuration, please refer to the ip as-path command in BGP configuration

### 34.2.2 IP Routing Policy Configuration Task List

- 1 · Define route-map
- 2 · Define the match clause in route-map
- 3 · Define the set clause in route-map
- 4 · Define address prefix list

#### 1. Define route-map

Command	Explanation
Global mode	
<b>route-map &lt;map_name&gt; {deny   permit} &lt;sequence_num&gt; no route-map &lt;map_name&gt; [{deny   permit} &lt;sequence_num&gt;]</b>	Configure route-map; the <b>no route-map &lt;map_name&gt; [{deny   permit} &lt;sequence_num&gt;]</b> command deletes the route-map.

#### 2. Define the match clause in route-map

Command	Explanation
Route-map configuration mode	
<b>match as-path &lt;list-name&gt; no match as-path [&lt;list-name&gt;]</b>	Match the autonomous system as path access-list the BGP route passes through; the <b>no match as-path [&lt;list-name&gt;]</b> command deletes match condition.

<p><b>match community</b> &lt;community-list-name   community-list-num &gt; [exact-match]  <b>no match community</b> [&lt;community-list-name   community-list-num &gt; [exact-match]]</p>	<p>Match a community property access-list. The <b>no match community</b> [&lt;community-list-name   community-list-num &gt; [exact-match]] command deletes match condition.</p>
<p><b>match interface</b> &lt;interface-name &gt;  <b>no match interface</b> [&lt;interface-name &gt;]</p>	<p>Match by ports; The <b>no match interface</b> [&lt;interface-name &gt;] command deletes match condition.</p>
<p><b>match ip</b> &lt;address   next-hop&gt; &lt;ip-acl-name   ip-acl-num   prefix-list list-name&gt;  <b>no match ip</b> &lt;address   next-hop&gt; [&lt;ip-acl-name   ip-acl-num   prefix-list [list-name]&gt;]</p>	<p>Match the address or next-hop; The <b>no match ip</b> &lt;address   next-hop&gt; [&lt;ip-acl-name   ip-acl-num   prefix-list [list-name]&gt;] command deletes match condition.</p>
<p><b>match metric</b> &lt;metric-val &gt;  <b>no match metric</b> [&lt;metric-val &gt;]</p>	<p>Match the routing metric value; The <b>no match metric</b> [&lt;metric-val &gt;] command deletes match condition.</p>
<p><b>match origin</b> &lt;egp   igp   incomplete &gt;  <b>no match origin</b> [&lt;egp   igp   incomplete &gt;]</p>	<p>Match the route origin; The <b>no match origin</b> [&lt;egp   igp   incomplete &gt;] command deletes match condition.</p>
<p><b>match route-type external</b> &lt;type-1   type-2 &gt;  <b>no match route-type external</b> [&lt;type-1   type-2 &gt;]</p>	<p>Match the route type; The <b>no match route-type external</b> [&lt;type-1   type-2 &gt;] command deletes match condition.</p>
<p><b>match tag</b> &lt;tag-val &gt;  <b>no match tag</b> [&lt;tag-val &gt;]</p>	<p>Match the route tag; The <b>no match tag</b> [&lt;tag-val &gt;] command deletes match condition.</p>

### 3. Define the set clause in route-map

Command	Explanation
Route-map configuration mode	
<b>set aggregator as &lt;as-number&gt; &lt;ip_addr&gt;</b> <b>no set aggregator as [ &lt;as-number&gt; &lt;ip_addr&gt; ]</b>	Distribute an AS No. for BGP aggregator; The no command deletes the configuration
<b>set as-path prepend &lt;as-num&gt;</b> <b>no set as-path prepend [ &lt;as-num&gt; ]</b>	Add a specified AS No. before the BGP routing messages as-path series; The no command deletes the configuration
<b>set atomic-aggregate</b> <b>no set atomic-aggregate</b>	Configure the BGP atomic aggregate property; The no command deletes the configuration
<b>set comm-list &lt;community-list-name   community-list-num&gt; delete</b> <b>no set comm-list &lt;community-list-name   community-list-num&gt; delete</b>	Delete BGP community list value; The no command deletes the configuration
<b>set community [AA:NN] [internet] [local-AS] [no-advertise] [no-export] [none] [additive]</b> <b>no set community [AA:NN] [internet] [local-AS] [no-advertise] [no-export] [none] [additive]</b>	Configure BGP community list value; The no command deletes the configuration
<b>set extcommunity &lt;rt   soo&gt; &lt;AA:NN&gt;</b> <b>no set extcommunity &lt;rt   soo&gt; [ &lt;AA:NN&gt; ]</b>	Configure BGP extended community list property; The no command deletes the configuration
<b>set ip next-hop &lt;ip_addr&gt;</b> <b>no set ip next-hop [ &lt;ip_addr&gt; ]</b>	Set next-hop IP address; The no command deletes the configuration
<b>set local-preference &lt;pre_val&gt;</b> <b>no set local-preference [ &lt;pre_val&gt; ]</b>	Set local preference; The no command deletes the configuration
<b>set metric &lt; +/- metric_val   metric_val&gt;</b> <b>no set metric [ +/- metric_val   metric_val ]</b>	Set routing metric value; The no command deletes the configuration
<b>set metric-type &lt;type-1   type-2&gt;</b> <b>no set metric-type [&lt;type-1   type-2&gt;]</b>	Set OSPF metric type; The no command deletes the configuration

<b>set origin &lt;egp   igp   incomplete &gt;</b> <b>no set origin [&lt;egp   igp   incomplete &gt;]</b>	Set BGP routing origin; The no command deletes the configuration
<b>set originator-id &lt;ip_addr&gt;</b> <b>no set originator-id [ &lt;ip_addr&gt; ]</b>	Set routing originator ID; The no command deletes the configuration
<b>set tag &lt;tag_val&gt;</b> <b>no set tag [ &lt;tag_val&gt; ]</b>	Set OSPF routing tag value; The no command deletes the configuration
<b>set vpnv4 next-hop &lt;ip_addr&gt;</b> <b>no set vpnv4 next-hop [ &lt;ip_addr&gt; ]</b>	Set BGP VPNv4 next-hop address; the no command deletes the configuration
<b>set weight &lt;weight_val&gt;</b> <b>no set weight [ &lt;weight_val&gt; ]</b>	Set BGP routing weight; The no command deletes the configuration

#### 4. Define address prefix list

Command	Explanation
Global mode	
<b>ip prefix-list &lt;list_name&gt; description &lt;description&gt;</b> <b>no ip prefix-list &lt;list_name&gt; description</b>	Describe the prefix list; The <b>no ip prefix-list &lt;list_name&gt; description</b> command deletes the configuration.
<b>ip prefix-list &lt;list_name&gt; [seq &lt;sequence_number&gt;]</b> <b>&lt;deny   permit&gt; &lt; any / ip_addr/mask_length [ge min_prefix_len] [le max_prefix_len]&gt;</b> <b>no ip prefix-list &lt;list_name&gt; [seq &lt;sequence_number&gt;]</b> <b>[&lt;deny   permit&gt; &lt; any / ip_addr/mask_length [ge min_prefix_len] [le max_prefix_len]&gt;]</b>	Set the prefix list; The <b>no ip prefix-list &lt;list_name&gt; [seq &lt;sequence_number&gt;] [&lt;deny   permit&gt; &lt; any / ip_addr/mask_length [ge min_prefix_len] [le max_prefix_len]&gt;]</b> command deletes the configuration.

### 34.2.3 Configuration Examples

The figure below shows a network consisting of four Layer 3 switches. This example demonstrates how to set the BGP as-path properties through route-map. BGP protocol is applied among the Layer 3 switches. As for switchC, the network 192.68.11.0/24 can be reached through two paths in which one is AS-PATH 1 by IBGP (going through SwitchD), the other one is AS-PATH 2 by EBGP (going through SwitchB). BGP selects the shortest path, so AS-PATH 1 is the preferred path.

If the path 2 is wished, which is through EBGP path, we can add two extra AS path numbers into the AS-PATH messages from SwitchA to SwitchD so as to change the determination SwitchC take to 192.68.11.0/24.

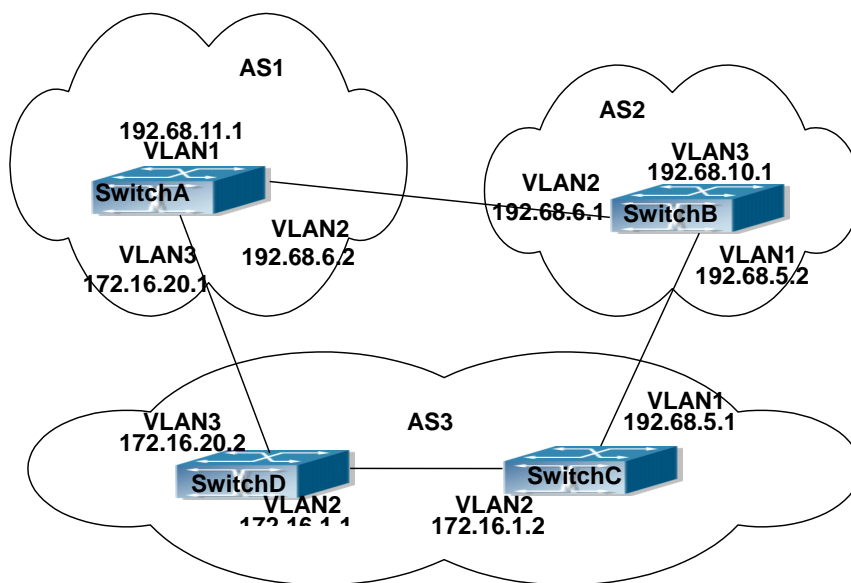

**Figure 34-1** Policy routing Configuration

Configuration procedure: (only SwitchA is listed, configurations for other switches are omitted.)

The configuration of Layer 3 switchA:

```
SwitchA#config
SwitchA(config) #router bgp 1
SwitchA(config-router)#network 192.68.11.0 mask 255.255.255.0
SwitchA(config-router)#neighbor 172.16.20.2 remote-as 3
SwitchA(config-router)#neighbor 172.16.20.2 route-map AddAsNumbers out
SwitchA(config-router)#neighbor 192.68.6.1 remote-as 2
SwitchA(config-router)#exit
SwitchA(config)#route-map AddAsNumbers permit 10
SwitchA(config-route-map)#set as-path prepend 1 1
```

### 34.2.4 Troubleshooting

**Faq:** The routing protocol could not achieve the routing messages study under normal protocol running state

**Troubleshooting:** check the following errors:

- Each node of route-map should at least has one node set to permit match mode. When the route map is used in routing messages filtering, the routing messages will be considered not passing the routing messages filtering if certain routing messages does not pass the filtering of any nodes. When all nodes are set to deny mode, all routing messages will not pass the filtering in this route-map.
- Items in address prefix list should at least have one item set to permit mode. The deny mode items can be defined first to quickly remove the unmatched routing messages, however, if all the items are set to deny mode, any route will not be able to pass the filtering of this address prefix list. We can define a permit 0.0.0.0/0 le 32 item after several deny mode items are defined so as to permit all other routing messages to pass through. Only default route will be matched in less-equal 32 not specified.

---

# Chapter 35 Static Route

## 35.1 Introduction to Static Route

As mentioned earlier, the static route is the manually specified path to a network or a host. Static route is simple and consistent, and can prevent illegal route modification, and is convenient for load balance and route backup. However, it also has its own defects. Static route, as its name indicates, is static, it won't modify the route automatically on network failure, and manual configuration is required on such occasions, therefore it is not suitable for mid and large-scale networks.

Static route is mainly used in the following two conditions: 1) in stable networks to reduce load of route selection and routing data streams. For example, static route can be used in route to STUB network. 2) For route backup, configure static route in the backup line, with a lower priority than the main line.

Static route and dynamic route can coexist; layer3 switch will choose the route with the highest priority according to the priority of routing protocols. At the same time, static route can be introduced (redistribute) in dynamic route, and change the priority of the static route introduced as required.

## 35.2 Introduction to Default Route

Default route is a kind of static route, which is used only when no matching route is found. In the route table, default route is indicated by a destination address of 0.0.0.0 and a network mask of 0.0.0.0, too. If the route table does not have the destination of a packet and has no default route configured, the packet will be discarded, and an ICMP packet will be sent to the source address indicate the destination address or network is unreachable.

## 35.3 Static Route Configuration Task List

1. Static route configuration
2. VRF configuration

### 1. Static route configuration

Command	Explanation
Global mode	
<code>ip route {&lt;ip-prefix&gt; &lt;mask&gt;   &lt;ip-prefix&gt;/&lt;prefix-length&gt;} {&lt;gateway-address&gt;   &lt;gateway-interface&gt;} [&lt;distance&gt;]</code> <code>no ip route {&lt;ip-prefix&gt; &lt;mask&gt;   &lt;ip-prefix&gt;/&lt;prefix-length&gt;} [&lt;gateway-address&gt;   &lt;gateway-interface&gt;} [&lt;distance&gt;]</code>	Set static routing; the <code>no ip route {&lt;ip-prefix&gt; &lt;mask&gt;   &lt;ip-prefix&gt;/&lt;prefix-length&gt;} [&lt;gateway-address&gt;   &lt;gateway-interface&gt;} [&lt;distance&gt;]</code> command deletes a static route entry

## 2. VRF configuration

Command	Explanation
Global mode	
<pre>ip route vrf &lt;name&gt; {&lt;ip-prefix&gt; &lt;mask&gt; &lt;ip-prefix/&lt;prefix-length&gt;} {&lt;gateway-address&gt; &lt;gateway-interface&gt;} [&lt;distance&gt;] no ip route vrf &lt;name&gt; {&lt;ip-prefix&gt; &lt;mask&gt; &lt;ip-prefix/&lt;prefix-length&gt;} [&lt;gateway-address&gt; &lt;gateway-interface&gt;} [&lt;distance&gt;]</pre>	Configure the static route, the no command will delete the static route.

## 35.4 Static Route Configuration Examples

The figure shown below is a simple network consisting of three layer3 switches, the network mask for all switches and PC is 255.255.255.0. PC-A and PC-C are connected via the static route set in SwitchA and SwitchC; PC3 and PC-B are connected via the static route set in SwitchC to SwitchB; PC-B and PC-C is connected via the default route set in SwitchB.

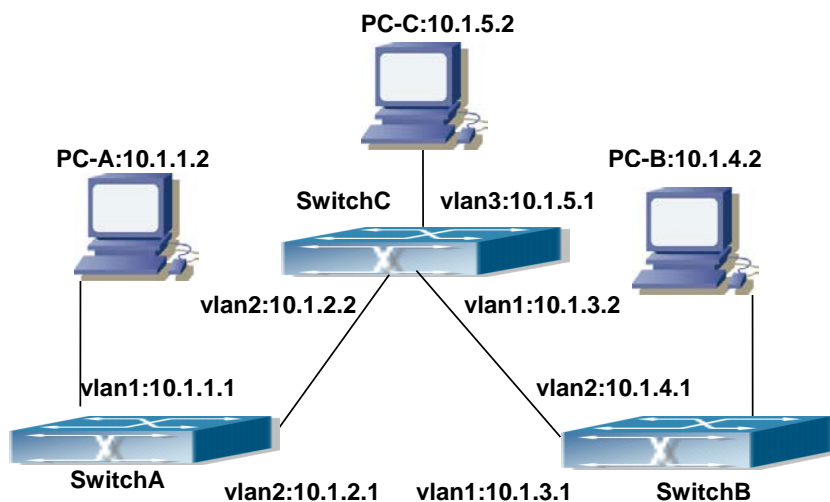

Figure 35-1 Static Route Configurations

---

Configuration steps:

Configuration of layer3 SwitchA

```
Switch#config
Switch (config) #ip route 10.1.5.0 255.255.255.0 10.1.2.2
Configuration of layer3 SwitchC
Switch#config
Next hop use the partner IP address
Switch(config)#ip route 10.1.1.0 255.255.255.0 10.1.2.1
Next hop use the partner IP address
Switch(config)#ip route 10.1.4.0 255.255.255.0 10.1.3.1
Configuration of layer3 SwitchB
Switch#config
Switch(config)#ip route 0.0.0.0 0.0.0.0 10.1.3.2
```

In this way, ping connectivity can be established between PC-A and PC-C, and PC-B and PC-C.



---

# Chapter 36 RIP

## 36.1 Introduction to RIP

RIP is first introduced in ARPANET, this is a protocol dedicated to small, simple networks. RIP is a distance vector routing protocol based on the Bellman-Ford algorithm. Network devices running vector routing protocol send two kind of information to the neighboring devices regularly:

- Number of hops to reach the destination network, or metrics to use or number of networks to pass.
- What is the next hop, or the director (vector) to use to reach the destination network.

The distance vector Layer 3 switch send all their route selecting tables to the neighbor layer3 switches at regular interval. A layer3 switch will build their own route selecting information table based on the information received from the neighbor layer3 switches. Then, it will send this information to its own neighbor layer3 switches. As a result, the route selection table is built on second hand information, route beyond 15 hops will be deemed as unreachable.

RIP protocol is an optional routing protocol based on UDP. Hosts using RIP send and receive packets on UDP port 520. All layer3 switches running RIP send their route table to all neighbor layer3 switches every 30 seconds for update. If no information from the partner is received in 180 seconds, then the device is deemed to have failed and the network connected to that device is considered to be unreachable. However, the route of that layer3 switch will be kept in the route table for another 120 seconds before deletion.

As layer3 switches running RIP built route table with second hand information, infinite count may occur. For a network running RIP routing protocol, when an RIP route becomes unreachable, the neighboring RIP layer3 switch will not send route update packets at once, instead, it waits until the update interval timeout (every 30 seconds) and sends the update packets containing that route. If before it receives the updated packet, its neighbors send packets containing the information about the failed neighbor, "infinite count" will be resulted. In other words, the route of unreachable layer3 switch will be selected with the metrics increasing progressively. This greatly affects the route selection and route aggregation time.

To prevent "infinite count", RIP provides mechanism such as "split horizon" and "triggered update" to solve route loop. "Split horizon" is done by avoiding sending to a gateway routes leaned from that gateway. There are two split horizon methods: "simple split horizon" and "poison reverse split horizon". Simple split horizon deletes from the route to be sent to the neighbor gateways the routes learnt from the neighbor gateways; poison reverse split horizon not only deletes the abovementioned routes, but set the costs of those routes to infinite. "Triggering update" mechanism defines whenever route metric changed by the gateway, the gateway advertise the update packets immediately, regardless of the 30 second update timer status.

There two versions of RIP, version 1 and version 2. RFC1058 introduces RIP-I protocol, RFC2453 introduces RIP-II, which is compatible with RFC1723 and RFC1388. RIP-I updates packets by packets broadcast, subnet mask and authentication is not supported. Some fields in the RIP-I packets are not used and are required to be all 0's; for this reason, such all 0's fields should be checked when using RIP-I, the RIP-I packets should be discarded if such fields are non-zero. RIP-II is a more improved version than RIP-I. RIP-II sends route update packets by multicast packets (multicast address is 224.0.0.9). Subnet mask field and RIP authentication filed

---

(simple plaintext password and MD5 password authentication are supported), and support variable length subnet mask. RIP-II used some of the zero field of RIP-I and require no zero field verification. switch send RIP-II packets in multicast by default, both RIP-I and RIP-II packets will be accepted.

Each layer3 switch running RIP has a route database, which contains all route entries for reachable destination, and route table is built based on this database. When a RIP layer3 switch sent route update packets to its neighbor devices, the complete route table is included in the packets. Therefore, in a large network, routing data to be transferred and processed for each layer3 switch is quite large, causing degraded network performance.

Besides the above mentioned, RIP protocol allows route information discovered by the other routing protocols to be introduced to the route table.

The operation of RIP protocol is shown below:

- 1 · Enable RIP. The switch sends request packets to the neighbor layer3 switches by broadcasting; on receiving the request, the neighbor devices reply with the packets containing their local routing information.
- 2 · The Layer3 switch modifies its local route table on receiving the reply packets and sends triggered update packets to the neighbor devices to advertise route update information. On receiving the triggered update packet, the neighbor lay3 switches send triggered update packets to their neighbor lay3 switches. After a sequence of triggered update packet broadcast, all layer3 switches get and maintain the latest route information.

In addition, RIP layer3 switches will advertise its local route table to their neighbor devices every 30 seconds. On receiving the packets, neighbor devices maintain their local route table, select the best route and advertise the updated information to their own neighbor devices, so that the updated routes are globally valid. Moreover, RIP uses a timeout mechanism for outdated route, that is, if a switch does not receive regular update packets from a neighbor within a certain interval (invalid timer interval), it considers the route from that neighbor invalid, after holding the route fro a certain interval (holddown timer interval), it will delete that route.

## 36.2 RIP Configuration Task List

1. Enable RIP (required)
  - (1) Enable/disable RIP module.
  - (2) Enable interface to send/receive RIP packets
2. Configure RIP protocol parameters (optional)
  - (1) Configure RIP sending mechanism
    - 1) Configure specified RIP packets transmission address
    - 2) Configure RIP interface broadcast
  - (2) Configure the RIP routing parameters
    - 1) Configure route introduction (default route metric, configure routes of the other protocols to be introduced in RIP)
    - 2) Configure interface authentication mode and password
    - 3) Configure the route deviation

- 
- 4) Configure and apply route filter
  - 5) Configure Split Horizon
  - (3) Configure other RIP protocol parameters
    - 1) Configure the managing distance of RIP route
    - 2) Configure the RIP route capacity limit in route table
    - 3) Configure the RIP update, timeout, holddown and other timer.
    - 4) Configure the receiving buffer size of RIP UDP
  - 3. Configure RIP-I/RIP-II switch
    - (1) Configure the RIP version to be used in all interfaces
    - (2) Configure the RIP version to send/receive in all interfaces
    - (3) Configure whether to enable RIP packets sending/receiving for interfaces
  - 4. Delete the specified route in RIP route table
  - 5. Configure the RIP routing aggregation
    - (1) Configure aggregation route of IPv4 route mode
    - (2) Configure aggregation route of IPv4 interface configuration mode
    - (3) Display IPv4 aggregation route information
  - 6. Configure redistribution of OSPF routing to RIP
    - (1) Enable Redistribution of OSPF routing to RIP
    - (2) Display and debug the information about configuration of redistribution of OSPF routing to RIP
  - 7. Configure VRF address family mode for RIP
    - (1) Enable/disable RIP module
    - (2) Configure VRF address family

### 1. Enable RIP protocol

Applying RIP route protocol with basic configuration in switch is simple. Normally you only have to open the RIP switch and configure the segments running RIP, namely send and receive the RIP data packet by default RIP configuration. The version of data packet sending and receiving is variable when needed, allow/deny sending, receiving RIP data packet. Refer to 3.

Command	Explanation
Global Mode	
<b>router rip</b> <b>no router rip</b>	Enables RIP; the “ <b>no router rip</b> ” command disables RIP.
Router and address family configuration mode	
<b>network &lt;A.B.C.D/M   ifname/vlan&gt;</b> <b>no network &lt;A.B.C.D/M   ifname/vlan&gt;</b>	Enables the segment running RIP protocol; the <b>no network &lt;A.B.C.D/M   ifname/vlan&gt;</b> command deletes the segment.

### 2. Configure RIP protocol parameters

- (1) **Configure RIP packet transmitting mechanism**
  - 1) Configure the RIP data packet point-transmitting
  - 2) Configure the RIP broadcast

Command	Explanation
Router Configuration Mode	
<b>neighbor &lt;A.B.C.D&gt;</b> <b>no neighbor &lt;A.B.C.D&gt;</b>	Specify the IP address of the neighbor router needs point-transmitting; the <b>no neighbor &lt;A.B.C.D&gt;</b> command cancels the appointed router.
<b>passive-interface&lt;ifname/vlan&gt;</b> <b>no passive-interface&lt;ifname/vlan &gt;</b>	Block the RIP broadcast on specified port and the RIP data packet is only transmittable among Layer 3 switch configured with neighbor. The <b>no passive-interface&lt;ifname/vlan &gt;</b> command cancels the function.

## (2) Configure RIP route parameters

1) Configure route introduction (default route metric, configure routes of the other protocols to be introduced in RIP)

Command	Explanation
Router Configuration Mode	
<b>default-metric &lt;value&gt;</b> <b>no default-metric</b>	Sets the default route metric for route to be introduced; the “ <b>no default-metric</b> ” command restores the default setting.
<b>redistribute {kernel  connected  static  ospf   isis  bgp} [metric&lt;value&gt;] [route-map&lt;word&gt;]</b> <b>no redistribute {kernel  connected  static  ospf   isis  bgp} [metric&lt;value&gt;] [route-map&lt;word&gt;]</b>	Redistribute the routes distributed in other routing protocols into the RIP data packet; the <b>no redistribute {kernel  connected  static  ospf   isis  bgp} [metric&lt;value&gt;] [route-map&lt;word&gt;]</b> command cancels the distributed route of corresponding protocols.
<b>default-information originate</b> <b>no default-information originate</b>	Generate a default route to the RIP protocol; the <b>no default-information originate</b> command cancels the feature.

2) Configure interface authentication mode and password

Command	Explanation
Interface configuration mode	
<b>ip rip authentication mode { text  md5}</b> <b>no ip rip authentication mode [text  md5]</b>	Sets the authentication method; the <b>no ip rip authentication mode [text  md5]</b> command cancels the authentication action.
<b>ip rip authentication string &lt;text&gt;</b> <b>no ip rip authentication string</b>	Sets the authentication key; the <b>no ip rip authentication string</b> command means no key is needed.

<b>ip rip authentication key-chain</b> <b>&lt;name-of-chain&gt;</b> <b>no ip rip authentication key-chain</b> <b>[&lt;name-of-chain&gt;]</b>	Sets the key chain used in authentication, the <b>no ip rip authentication key-chain [&lt;name-of-chain&gt;]</b> command means the key chain is not used.
<b>ip rip authentication cisco-compatible</b> <b>no ip rip authentication</b> <b>cisco-compatible</b>	After configure this command, configure MD5 authentication, then can receive RIP packet of cisco, the no command restores the default configuration.
Global mode	
<b>key chain &lt;name-of-chain&gt;</b> <b>no key chain &lt; name-of-chain &gt;</b>	Enter keychain mode, and configure a key chain, the <b>no key chain &lt; name-of-chain &gt;</b> command deletes the key chain.
Keychain mode	
<b>key &lt;keyid&gt;</b> <b>no key &lt;keyid&gt;</b>	Enter the keychain-key mode and configure a key of the keychain; the <b>no key &lt;keyid&gt;</b> command deletes one key.
Keychain-key mode	
<b>key-string &lt;text&gt;</b> <b>no key-string &lt;text&gt;</b>	Configure the password used by the key, the <b>no key-string &lt;text&gt;</b> command deletes the password.
<b>accept-lifetime &lt;start-time&gt;</b> <b>{&lt;end-time&gt;  duration&lt;seconds&gt; </b> <b>infinite}</b> <b>no accept-lifetime</b>	Configure a key on the key chain and accept it as an authorized time; the <b>no accept-lifetime</b> command deletes it.
<b>send-lifetime &lt;start-time&gt; {&lt;end-time&gt; </b> <b>duration&lt;seconds&gt;  infinite}</b> <b>no send-lifetime</b>	Configure the transmitting period of a key on the key chain; the <b>no send-lifetime</b> command deletes the send-lifetime.

### 3) Configure the route deviation

Command	Explanation
Router configuration mode	
<b>offset-list &lt;access-list-number  </b> <b>access-list-name&gt; {in   out } &lt;number&gt;</b> <b>[&lt;ifname&gt;]</b> <b>no offset-list &lt;access-list-number</b> <b> access-list-name&gt;</b> <b>{in out }&lt;number &gt;[&lt;ifname&gt;]</b>	Configure that provide a deviation value to the route metric value when the port sends or receives RIP data packet; the <b>no offset-list &lt;access-list-number  access-list-name&gt; {in out } &lt;number &gt;[&lt;ifname&gt;]</b> command removes the deviation table.

4) Configure and apply the route filtering

Command	Explanation
Router configuration mode	
<b>distribute-list</b> {< <i>access-list-number</i> / <i>access-list-name</i> >  <i>prefix</i> < <i>prefix-list-name</i> >}{ <i>in</i>   <i>out</i> } [ <i>ifname</i> ] <b>no distribute-list</b> {< <i>access-list-number</i> / <i>access-list-name</i> >  <i>prefix</i> < <i>prefix-list-name</i> >}{ <i>in</i>   <i>out</i> } [ <i>ifname</i> ]	Configure and apply the access table and prefix table to filter the routes. The <b>no distribute-list</b> {< <i>access-list-number</i> / <i>access-list-name</i> >  <i>prefix</i> < <i>prefix-list-name</i> >}{ <i>in</i>   <i>out</i> } [ <i>ifname</i> ] command means do not use the access table and prefix table.

5) Configure the split horizon

Command	Explanation
Interface configuration mode	
<b>ip rip split-horizon</b> [ <i>poisoned</i> ] <b>no ip rip split-horizon</b>	Configure that take the split horizon when the port sends data packets; <i>poisoned</i> for poison reverse the <b>no ip rip split-horizon</b> command cancels the split horizon.

(3) Configure other RIP protocol parameters

- 1) Configure RIP routing priority
- 2) Configure the RIP route capacity limit in route table
- 3) Configure timer for RIP update, timeout and hold-down
- 4) Configure RIP UDP receiving buffer size

Command	Explanation
Router configuration mode	
<b>distance</b> < <i>number</i> > [< <i>A.B.C.D/M</i> > ] [< <i>access-list-name</i> / <i>access-list-number</i> >] <b>no distance</b> [< <i>A.B.C.D/M</i> > ]	Specify the route administratively distance of RIP protocol; the <b>no distance</b> [< <i>A.B.C.D/M</i> > ] command restore the default value 120.
<b>maximum-prefix</b> < <i>maximum-prefix</i> >[< <i>threshold</i> >] <b>no maximum-prefix</b> < <i>maximum-prefix</i> > <b>no maximum-prefix</b>	Configure the maximum of RIP route; the <b>no maximum-prefix</b> < <i>maximum-prefix</i> > <b>no maximum-prefix</b> command cancels the limit.
<b>timers basic</b> < <i>update</i> > < <i>invalid</i> > < <i>garbage</i> > <b>no timers basic</b>	Adjust the update, timeout and garbage collection time, the <b>no timers basic</b> command restores the default configuration.
<b>recv-buffer-size</b> < <i>size</i> > <b>no recv-buffer-size</b>	The command configures the UDP receiving buffer size of the RIP; the <b>no recv-buffer-size</b> command restores the system default values.

3. Configure RIP-I/RIP-II toggling

- (1) Configure the RIP version to be used in all ports

Command	Explanation
RIP configuration mode	
<b>version { 1   2 }</b> <b>no version</b>	Configure the versions of all the RIP data packets transmitted/received by the Layer 3 switch port sending/receiving the <b>no version</b> command restores the default configuration, version 2.

- (2) Configure the RIP version to send/receive in all ports.
- (3) Configure whether to enable RIP packets sending/receiving for ports

Command	Explanation
Interface configuration mode	
<b>ip rip send version { 1   1-compatible   2 }</b> <b>no ip rip send version</b>	Sets the version of RIP packets to send on all ports; the <b>no ip rip send version</b> command set the version to the one configured by the version command.
<b>ip rip receive version { 1   2   }</b> <b>no ip rip receive version</b>	Sets the version of RIP packets to receive on all ports; the no action of this command set the version to the one configured by the version command.
<b>ip rip receive-packet</b> <b>no ip rip receive-packet</b>	Enables receiving RIP packets on the interface; the <b>no ip rip receive-packet</b> command close data receiving on this port.
<b>ip rip send-packet</b> <b>no ip rip send-packet</b>	Enables sending RIP packets on the interface; the “ <b>no ip rip send-packet</b> ” command disables sending RIP packets on the interface.

#### 4. Delete the specified route in RIP route table

Command	Explanation
Admin Mode	
<b>clear ip rip route</b> <b>{&lt;A.B.C.D/M&gt; kernel static connected r</b> <b>ip ospf isis bgp all}</b>	The command deletes a specified route from the RIP route table.

## 5. Configure the RIP routing aggregation

### (1) Configure IPv4 aggregation route globally

Command	Explanation
Router Configuration Mode	
<b>ip rip aggregate-address A.B.C.D/M</b> <b>no ip rip aggregate-address A.B.C.D/M</b>	To configure or delete IPv4 aggregation route globally.

### (2) Configure IPv4 aggregation route on interface

Command	Explanation
Interface Configuration Mode	
<b>ip rip aggregate-address A.B.C.D/M</b> <b>no ip rip aggregate-address A.B.C.D/M</b>	To configure or delete IPv4 aggregation route on interface.

### (3) Display IPv4 aggregation route information

Command	Explanation
Admin Mode and Configuration Mode	
<b>show ip rip aggregate</b>	To display aggregation route information.

## 6. Configure redistribution of OSPF routing to RIP

### (1) Enable Redistribution of OSPF routing to RIP

Command	Explanation
Router RIP Configuration Mode	
<b>redistribute ospf [ &lt;process-id&gt; ] [metric &lt;value&gt; ] [route-map &lt;word&gt; ]</b> <b>no redistribute ospf [ &lt;process-id&gt; ]</b>	To enable or disable the redistribution of OSPF routing to RIP.

### (2) Display and debug the information about configuration of redistribution of OSPF routing to RIP

Command	Explanation
Admin Mode and Configuration Mode	
<b>show ip rip redistribute</b>	To display the information about configuration of redistribute from other routing.
Admin Mode	
<b>debug rip redistribute message send</b> <b>no debug rip redistribute message send</b> <b>debug rip redistribute route receive</b> <b>no debug rip redistribute route receive</b>	To enable or disable debugging messages sent by RIP for redistribution of OSPF routing. To enable or disable debugging messages received from NSM.



## 7. Configure VRF address family mode for RIP

Command	Explanation
Router RIP configuration mode	
<b>address-family ipv4 vrf &lt;vrf-name&gt;</b> <b>no address-family ipv4 vrf &lt;vrf-name&gt;</b>	The command configures a RIP address family on the VRF of the PE router; the no command deletes the configured address family.
Address family configuration mode	
<b>exit-address-family</b>	This command exits the address family mode.

## 36.3 RIP Examples

### 36.3.1 Typical RIP Examples

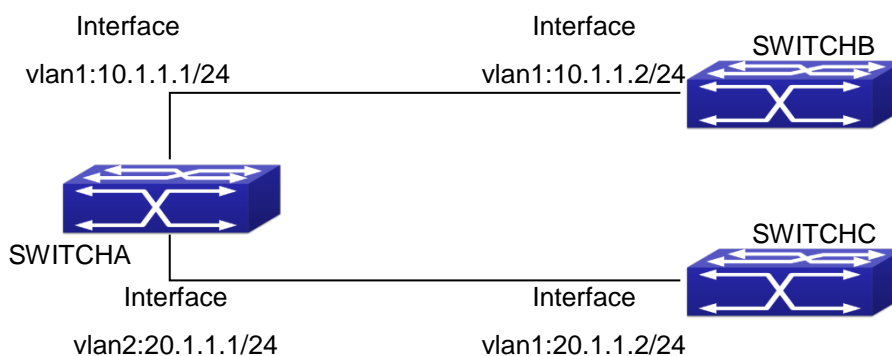

**Figure 36-1** RIP example

In the figure shown above, a network consists of three Layer 3 switches, in which SwitchA connected with SwitchB and SwitchC, and RIP routing protocol is running in all of the three switches. SwitchA (interface vlan1 : 10.1.1.1, interface vlan2 : 20.1.1.1) exchanges Layer 3 switch update messages only with SwitchB (interface vlan1 : 10.1.1.2), but not with SwitchC (interface vlan 2: 20.1.1.2).

SwitchA, SwitchB, SwitchC configurations are as follows:

---

**a) Layer 3 SwitchA :**

Configure the IP address of interface vlan 1

```
SwitchA#config
SwitchA(config)# interface vlan 1
SwitchA(Config-if-Vlan1)# ip address 10.1.1.1 255.255.255.0
SwitchA(config-if-Vlan1)#
Configure the IP address of interface vlan 2
SwitchA(config)# vlan 2
SwitchA(Config-Vlan2)# switchport interface ethernet 1/0/2
Set the port Ethernet1/0/1 access vlan 2 successfully
SwitchA(Config-Vlan2)# exit
SwitchA(config)# interface vlan 2
SwitchA(Config-if-Vlan2)# ip address 20.1.1.1 255.255.255.0
Initiate RIP protocol and configure the RIP segments
SwitchA(config)#router rip
SwitchA(config-router)#network vlan 1
SwitchA(config-router)#network vlan 2
SwitchA(config-router)#exit
Configure that the interface vlan 2 do not transmit RIP messages to SwitchC
SwitchA(config)#router rip
SwitchA(config-router)#passive-interface vlan 2
SwitchA(config-router)#exit
SwitchA(config) #
```

**b) Layer 3 SwitchB**

Configure the IP address of interface vlan 1

```
SwitchB#config
SwitchB(config)# interface vlan 1
SwitchB(Config-if-Vlan1)# ip address 10.1.1.2 255.255.255.0
SwitchB(Config-if-Vlan1)#exit
Initiate RIP protocol and configure the RIP segments
SwitchB(config)#router rip
SwitchB(config-router)#network vlan 1
SwitchB(config-router)#exit
```

### c) Layer 3 SwitchC

Configure the IP address of interface vlan 1

```
SwitchC#config
SwitchC(config)# interface vlan 1
Configure the IP address of interface vlan 1
SwitchC(Config-if-Vlan1)# ip address 20.1.1.2 255.255.255.0
SwitchC(Config-if-Vlan1)#exit
Initiate RIP protocol and configure the RIP segments
SwitchC(config)#router rip
SwitchC(config-router)#network vlan 1
SwitchC(config-router)#exit
```

## 36.3.2 Typical Examples of RIP aggregation function

The application topology as follows :

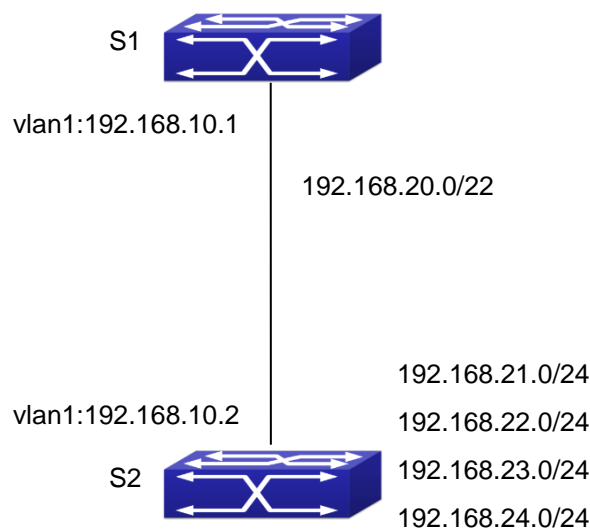

**Figure 36-2** Typical application of RIP aggregation

As the above network topology, S2 is connected to S1 through interface vlan1, there are other 4 subnet routers of S2, which are 192.168.21.0/24, 192.168.22.0/24, 192.168.23.0/24, 192.168.24.0/24. S2 supports route aggregation, and to configure aggregation route 192.168.20.0/22 in interface vlan1 of S2, after that, sending router messages to S1 through vlan1, and put the four subnet routers aggregated to one router as 192.168.20.0/22, and send to S1, and not send subnet to neighbor. It can reduce the router table of S1, save the memory.

---

### S1 configuration list:

```
S1(config)#router rip
S1(config-router) #network vlan 1
S2 configuration list:
S2(config)#router rip
S2(config-router) #network vlan 1
S2(config-router) #exit
S2(config)#in vlan 1
S2(Config-if-Vlan1)# ip rip agg 192.168.20.0/22
```

## 36.4 RIP Troubleshooting

The RIP protocol may not be working properly due to errors such as physical connection and configuration error when configuring and using the RIP protocol. So users should pay attention to the following:

- First ensure the physical connection is correct
- Second, ensure the interface and chain protocol are UP (use **show interface** command)
- Then initiate the RIP protocol (use **router rip** command) and configure the segment (use **network** command) and set RIP protocol parameter on corresponding interfaces, such as the option between RIP-I and RIP-II
- After that, one feature of RIP protocol should be noticed -- the Layer 3 switch running RIP protocol, sending route and updating messages to all neighboring Layer 3 switches every 30 seconds. A Layer 3 switch is considered inaccessible if no route updating messages from the switch is received within 180 seconds, then the route to the switch will remain in the route table for 120 seconds before it is deleted. Therefore, if an RIP route is deleted, this route item is assured to be deleted from route table after 300 seconds.
- When exchanging routing messages with CE using RIP protocol on the PE router, we should first create corresponding VPN routing/transmitting examples to associate with corresponding interfaces. Then enter the RIP address family mode configuring corresponding parameters. If the RIP routing problem remains unresolved, please use debug rip command to record the debug message in three minutes, and send them to our technical service center.

---

# Chapter 37 RIPng

## 37.1 Introduction to RIPng

RIPng is first introduced in ARPANET; this is a protocol dedicated to small, simple networks. RIPng is a distance vector routing protocol based on the Bellman-Ford algorithm. Network devices running vector routing protocol send 2 kinds of information to the neighboring devices regularly:

- Number of hops to reach the destination network, or metrics to use or number of networks to pass.
- What is the next hop, or the director (vector) to use to reach the destination network.

Distance vector layer3 switches send all their route selecting tables to the neighbor layer3 switches at regular interval. A Layer3 switch will build their own route selecting information table based on the information received from the neighbor Layer3 switches. Then, it will send this information to its own neighbor Layer3 switches. As a result, the route selection table is built on second hand information, route beyond 15 hops will be deemed as unreachable.

RIPng is an optional routing protocol based on UDP. Hosts using RIPng send and receive packets on UDP port 521. All Layer3 switches running RIP send their route table to all neighbor Layer3 switches every 30 seconds for update. If no information from the partner is received in 180 seconds, then the device is deemed to have failed and the network connected to that device is considered to be unreachable. However, the route of that Layer3 switch will be kept in the route table for another 120 seconds before deletion.

As Layer3 switches running RIPng build route table with second hand information, infinite count may occur. For a network running RIPng routing protocol, when a RIPng route becomes unreachable, the neighboring RIPng Layer3 switch will not send route update packets at once, instead, it waits until the update interval timeout (every 30 seconds) and sends the update packets containing that route. If before it receives the updated packet, its neighbors send packets containing the information about the failed neighbor, "infinite count" will be resulted. In other words, the route of unreachable Layer3 switch will be selected with the metrics increasing progressively. This greatly affects the route selection and route aggregation time.

To avoid "infinite count", RIPng provides mechanism such as "split horizon" and "triggered update" to solve route loop. "Split horizon" is done by avoiding sending to a gateway routes learned from that gateway. There are two split horizon methods: "simple split horizon" and "poison reverse split horizon". Simple split horizon deletes from the route to be sent to the neighbor gateways the routes learnt from the neighbor gateways; poison reverse split horizon not only deletes the abovementioned routes, but set the costs of those routes to infinite. "Triggering update" mechanism defines whenever route metric changed by the gateway, the gateway advertise the update packets immediately other than wait for the 30 sec timer.

So far the RIPng protocol has got only one version -- Version1: RIPng protocol is introduced in RFC 2080. RIPng transmits updating data packet by multicast data packet (multicast address FF02::9)

---

Each layer3 switch running RIPng has a route database, which contains all route entries for reachable destination, and route table is built based on this database. When a RIPng layer3 switch sent route update packets to its neighbor devices, the complete route table is included in the packets. Therefore, in a large network, routing data to be transferred and processed for each layer3 switch is quite large, causing degraded network performance.

Besides the above mentioned, RIPng protocol allows IPv6 route information discovered by the other routing protocols to be introduced to the route table.

The operation of RIPng protocol is shown below:

- 1 · Enable RIPng The switch sends request packets to the neighbor layer3 switches by broadcasting; on receiving the request, the neighbor devices reply with the packets containing their local routing information.
- 2 · The Layer3 switch modifies its local route table on receiving the reply packets and sends triggered update packets to the neighbor devices to advertise route update information. On receiving the triggered update packet, the neighbor lay3 switches send triggered update packets to their neighbor lay3 switches. After a sequence of triggered update packet broadcast, all layer3 switches get and maintain the latest route information.

In addition, RIPng layer3 switches will advertise its local route table to their neighbor devices every 30 seconds. On receiving the packets, neighbor devices maintain their local route table, select the best route and advertise the updated information to their own neighbor devices, so that the updated routes are globally valid. Moreover, RIP uses a timeout mechanism for outdated route, that is, if a switch does not receive regular update packets from a neighbor within a certain interval (invalid timer interval), it considers the route from that neighbor invalid, after holding the route fro a certain interval (garbage collect timer interval), it will delete that route.

As a result of continuous development of IPv6 network, it has the network environment of nonsupport IPv6 sometimes, so it needs to do the IPv6 operation by tunnel. Therefore, our RIPng supports configuration on configure tunnel, and passes through nonsupport IPv6 network by unicast packet of IPv4 encapsulation.

## 37.2 RIPng Configuration Task List

RIPng Configuration Task List:

1. Enable RIPng protocol (required)
  - (1) Enable/disable RIPng protocol
  - (2) Configure the interfaces running RIPng protocol
2. Configure RIPng protocol parameters (optional)
  - (1) Configure RIPng sending mechanism
    - 1) Configure specified RIPng packets transmission address
  - (2) Configure RIP routing parameters
    - 1) Configure route introduction (default route metric, configure routes of the other protocols to be introduced in RIPng)
    - 2) Configure the route deviation
    - 3) Configure and apply route filter

- 4) Configure split horizon
3. Configure other RIPng parameters
  - (1) Configure timer for RIPng update, timeout and hold-down
4. Delete the specified route in RIPng route table
5. Configure RIPng route aggregation
  - (1) Configure aggregation route of IPv6 route mode
  - (2) Configure aggregation route of IPv6 interface configuration mode
  - (3) Display IPv6 aggregation route information
6. Configure redistribution of OSPFv3 routing to RIPng
  - (1) Enable redistribution of OSPFv3 routing to RIPng
  - (2) Display and debug the information about configuration of redistribution of OSPFv3 routing to RIPng

### 1. Enable RIPng protocol

Applying RIPng route protocol with basic configuration in switch is simple. Normally you only have to open the RIPng switch and configure the segments running RIPng, namely send and receive the RIPng data packet by default RIPng configuration.

Command	Explanation
Global mode	
<b>[no] router IPv6 rip</b>	Enables the RIPng protocol; the [no] router IPv6 rip command shuts the RIPng protocol.
Interface configuration mode	
<b>[no] IPv6 router rip</b>	Configure the interface to run RIPng protocol; the [no] IPv6 router rip command set the interface not run RIPng protocol.

### 2. Configure RIPng protocol parameters

#### (1) Configure RIPng sending mechanism

- 1) Configure the RIPng data packets point-transmitting

Command	Explanation
Router configuration mode	
<b>[no] neighbor &lt;IPv6-address&gt; &lt;ifname&gt;</b>	Specify the IPv6 Link-local address and interface of the neighboring route needs point-transmitting; the [no] neighbor <IPv6-address> <ifname> command cancels the appointed router.
<b>[no] passive-interface &lt;ifname&gt;</b>	Block the RIPng multicast on specified port and the RIPng data packet is only transmittable among Layer 3 switch configured with neighbor. the [no] passive-interface <ifname> command cancels the function.

## (2) Configure RIP routing parameters

1) Configure route introduction (default route metric, configure routes of the other protocols to be introduced in RIP)

Command	Explanation
Router configuration mode	
<b>default-metric &lt;value&gt;</b> <b>no default-metric</b>	Configure the default metric of distributed route; the <b>no default-metric</b> command restores the default configuration 1.
<b>[no]redistribute {kernel  connected  static  ospf  isis  bgp}</b> <b>[metric&lt;value&gt;] [route-map&lt;word&gt;]</b>	Redistribute the routes distributed in other route protocols into the RIPng data packet; the <b>[no]redistribute {kernel  connected  static  ospf  isis  bgp} [metric&lt;value&gt;] [route-map&lt;word&gt;]</b> command cancels the distributed route of corresponding protocols.
<b>[no]default-information originate</b>	Generate a default route to the RIPng protocol; the <b>[no] default-information originate</b> command cancels the feature.

2) Configure the route offset

Command	Explanation
Router configuration mode	
<b>[no] offset-list &lt;access-list-number  access-list-name&gt; {in out} &lt;number &gt; [&lt;ifname&gt;]</b>	Configure that provide a deviation value to the route metric value when the port sends or receives RIPng data packet; the <b>[no] offset-list &lt;access-list-number  access-list-name&gt; {in out} &lt;number &gt; [&lt;ifname&gt;]</b> command removes the deviation table.

3) Configure and apply route filter and route aggregation

Command	Explanation
Router configuration mode	
<b>[no] distribute-list {&lt;access-list-number  access-list-name&gt;   prefix&lt;prefix-list-name&gt;} {in out} [&lt;ifname&gt;]</b>	Set to filter the route when the interface sends and receives RIPng data packets. The <b>[no] distribute-list {&lt; access-list-number  access-list-name &gt;   prefix&lt;prefix-list-name&gt;} {in out} [&lt;ifname&gt;]</b> command means do not set the route filter.
<b>[no]aggregate-address &lt;IPv6-address&gt;</b>	Configure route aggregation, the <b>[no] aggregate-address &lt;IPv6-address&gt;</b> command cancels the route aggregation.



#### 4) Configure split horizon

Command	Explanation
Interface configuration mode	
<b>IPv6 rip split-horizon [poisoned]</b>	Configure that take the split-horizon when the port sends data packets, poisoned means with poison reverse.
<b>no IPv6 rip split-horizon</b>	Cancel the split-horizon.

### 3. Configure other RIPng protocol parameters

#### (1) Configure timer for RIPng update, timeout and hold-down

Command	Explanation
Router configuration mode	
<b>timers basic &lt;update&gt; &lt;invalid&gt; &lt;garbage&gt;</b> <b>no timers basic</b>	Adjust the renew, timeout and garbage recycle RIPng timer, the no timers basic command restore the default configuration.

#### 4. Delete the specified route in RIPng route table

Command	Explanation
Admin Mode	
<b>clear IPv6 rip route</b> <b>{&lt;IPv6-address&gt; kernel static connected rip ospf isis bgp all}</b>	the command deletes a specified route from the RIP route table.

### 5. Configure RIPng route aggregation

#### (1) Configure IPv6 aggregation route globally

Command	Explanation
Router Configuration Mode	
<b>ipv6 rip aggregate-address</b> <b>X:X::X:X/M</b> <b>no ipv6 rip aggregate-address</b> <b>X:X::X:X/M</b>	To configure or delete IPv6 aggregation route globally.

(2) Configure IPv6 aggregation route on interface

Command	Explanation
Interface Configuration Mode	
<b>ipv6 rip aggregate-address</b> <b>X:X::X:X/M</b> <b>no ipv6 rip aggregate-address</b> <b>X:X::X:X/M</b>	To configure or delete IPv6 aggregation route on interface.

(3) Display IPv6 aggregation route information

Command	Explanation
Admin Mode and Configuration Mode	
<b>show ipv6 rip aggregate</b>	To display IPv6 aggregation route information, such as aggregation interface, metric, numbers of aggregation route, times of aggregation.

## 6. Configure redistribution of OSPFv3 routing to RIPng

### (1) Enable redistribution of OSPFv3 routing to RIPng

Command	Explanation
Router IPv6 RIP Configuration Mode	
<b>redistribute ospf [&lt;process-tag&gt;]</b> <b>[metric&lt;value&gt;] [route-map&lt;word&gt;]</b> <b>no redistribute ospf [&lt;process-tag&gt;]</b>	To enable or disable redistribution of OSPFv3 routing for RIPng.

### (2) Display and debug the information about configuration of redistribution of OSPFv3 routing to RIPng

Command	Explanation
Admin Configuration Mode	
<b>show ipv6 rip redistribute</b>	To display RIPng routing which is redistributed from other routing protocols.
Admin Mode	
<b>debug ipv6 rip redistribute message send</b> <b>no debug ipv6 rip redistribute message send</b> <b>debug ipv6 rip redistribute route receive</b> <b>no debug ipv6 rip redistribute route receive</b>	To enable or disable debugging messages sent by RIPng for redistribution of OSPFv3 routing. To enable or disable debugging route messages received from NSM.

## 37.3 RIPng Configuration Examples

### 37.3.1 Typical RIPng Examples

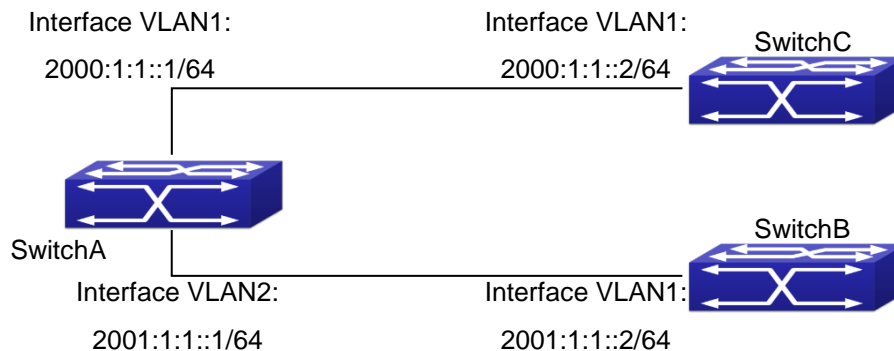

**Figure 37-1** RIPng Example

As shown in the above figure, a network consists of three layer 3 switches. SwitchA and SwitchB connect to SwitchC through interfaces vln1 and vln2. All the three switches are running RIPng. Assume SwitchA (VLAN1 :2001:1:1::1/64 and VLAN2 :2001:1:1::1/64) exchange update information with SwitchB (VLAN1 : 2001:1:1::2/64) only, update information is not exchanged between SwitchA and SwitchC (VLAN1 : 2001:1:1::2/64) .

The configuration for SwitchA, SwitchB and SwitchC is shown below:

#### Layer 3 SwitchA

##### Enable RIPng protocol

```
SwitchA(config)#router IPv6 rip
SwitchA(config-router)#exit
Configure the IPv6 address in vln1 and configure vln1 to run RIPng
SwitchA#config
SwitchA(config)# interface Vln1
SwitchA(config-if-Vln1)# IPv6 address 2000:1:1::1/64
SwitchA(config-if-Vln1)#IPv6 router rip
SwitchA(config-if-Vln1)#exit
Configure the IPv6 address in vln2 and configure vln2 to run RIPng
SwitchA(config)# interface Vln2
SwitchA(config-if-Vln2)#IPv6 address 2001:1:1::1/64
SwitchA(config-if-Vln2)#IPv6 router rip
SwitchA(config-if-Vln2)#exit
```

Configure the interface vln1 do not send RIPng messages to SwitchC

```
SwitchA(config)#
SwitchA(config-router)#passive-interface Vln1
SwitchA(config-router)#exit
```

Layer 3 SwitchB  
Enable RIPng protocol

```
SwitchB (config)#router IPv6 rip  
SwitchB (config-router-rip)#exit
```

Configure the IPv6 address and interfaces of Ethernet port vlan1 to run RIPng

```
SwitchB#config  
SwitchB(config)# interface Vlan1  
SwitchB(config-if)# IPv6 address 2001:1:1::2/64  
SwitchB(config-if)#IPv6 router rip  
SwitchB(config-if)#exit
```

**Layer 3 SwitchC**  
Enable RIPng protocol

```
SwitchC(config)#router IPv6 rip  
SwitchC(config-router-rip)#exit  
Configure the IPv6 address and interfaces of Ethernet port vlan1 to run RIPng  
SwitchC#config  
SwitchC(config)# interface Vlan1  
SwitchC(config-if)# IPv6 address 2000:1:1::2/64  
SwitchC(config-if)#IPv6 router rip  
SwitchC(config-if)#exit
```

### 37.3.2 RIPng Aggregation Route Function Typical Examples

The application topology is as follows:

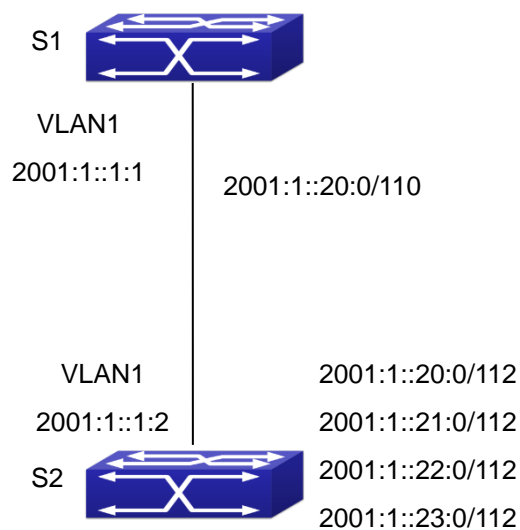

**Figure 37-2** Typical application of RIPng aggregation

---

As the above network topology, S2 is connected to S1 through interface vlan1, there are other 4 subnet routers of S2, which are 2001:1::20:0/112, 2001:1::21:0/112, 2001:1::22:0/112, 2001:1::23:0/112. S2 supports route aggregation, and to configure aggregation route 2001:1::20:0/110 in interface vlan1 of S2, after that, sending router messages to S2 through vlan1, and put the four subnet routers aggregated to one router as 2001:1::20:0/110, and send to S1, and not send subnet to neighbor. It can reduce the router table of S1, save the memory.

#### S1 configuration list:

```
S1(config)#router ipv6 rip
S1(config-router) #network vlan 1
S2 configuration list:
S2(config)#router ipv6 rip
S2(config-router) #network vlan 1
S2(config-router) #exit
S2(config)#in vlan 1
S2(Config-if-Vlan1)# ipv6 rip agg 2001:1::20:0/110
```

## 37.4 RIPng Troubleshooting

The RIPng protocol may not be working properly due to errors such as physical connection and configuration error when configuring and using the RIPng protocol. So users should pay attention to the following:

- First ensure the physic connection is correct and the IP Forwarding command is open
- Second, ensure the interface and link layer protocol are UP (use **show interface** command)
- Then initiate the RIPng protocol (use **router IPv6 rip** command) and configure the port (use **IPv6 router** command), and set RIPng protocol parameter on corresponding interfaces.
- After that, a RIPng protocol feature should be noticed --the Layer 3 switch running RIPng transmits the route updating messages every 30 seconds. A Layer 3 switch is considered inaccessible if no route updating messages from the switch are received within 180 seconds, then the route to the switch will remains in the route table for 120 seconds before it is deleted. Therefore, if to delete a RIPng route, this route item is assured to be deleted from route table after 300 seconds.

The RIPng protocol may not be working properly due to errors such as physic connection, configuration error when configuring and using the RIPng protocol. So users should pay attention to the following:

- First ensure the physic connection is correct and the IP Forwarding command is open
- Second, ensure the interface and link layer protocol are UP (use **show interface** command)
- Then initiate the RIPng protocol (use **router IPv6 rip** command) and configure the port (use **IPv6 router** command), and set RIPng protocol parameter on corresponding interfaces.

- 
- After that, a RIPng protocol feature should be noticed ---the Layer 3 switch running RIPng transmits the route updating messages every 30 seconds. A Layer 3 switch is considered inaccessible if no route updating messages from the switch are received within 180 seconds, then the route to the switch will remain in the route table for 120 seconds before it is deleted. Therefore, if to delete a RIPng route, this route item is assured to be deleted from route table after 300 seconds.
  - If the RIP routing problem remains unresolved, please use **debug IPv6 rip** command to record the debug message in three minutes, and send them to our technical service center.

---

# Chapter 38 OSPF

## 38.1 Introduction to OSPF

OSPF is abbreviation for Open Shortest Path First. It is an interior dynamic routing protocol for autonomous system based on link-state. The protocol creates a link-state database by exchanging link-states among layer3 switches, and then uses the Shortest Path First algorithm to generate a route table basing on that database.

Autonomous system (AS) is a self-managed interconnected network. In large networks, such as the Internet, a giant interconnected network is broken down to autonomous systems. Big enterprise networks connecting to the Internet are independent AS, since the other hosts on the Internet are not managed by those AS and they don't share interior routing information with the layer3 switches on the Internet.

Each link-state Layer3 switch can provide information about the topology with its neighboring Layer3 switches.

- The network segment (link) connecting to the layer3 switch
- State of the connecting link

Link-state information is flooded throughout the network so that all Layer3 switches can get firsthand information. Link-state Layer3 switches will not broadcast all information contained in their route tables; instead, they only send changed link-state information. Link-state Layer3 switches establish neighborhood by sending "HELLO" to their neighbors, then link-state advertisements (LSA) will be sent among neighboring Layer3 switches. Neighboring Layer3 switch copy the LSA to their routing table and transfer the information to the rest part of the network. This process is referred to as "flooding". In this way, firsthand information is sent throughout the network to provide accurate map for creating and updating routes in the network. Link-state routing protocols use cost instead of hops to decide the route. Cost is assigned automatically or manually. According to the algorithm in link-state protocol, cost can be used to calculate the hop number for packets to pass, link bandwidth, and current load of the link. The administrator can even add weight for better assessment of the link-state.

- 1) When a link-state Layer3 switch enters a link-state interconnected network, it sends a HELLO packet to get to know its neighbors and establish neighborhood.
- 2) The neighbors respond with information about the links they are connecting and the related costs.
- 3) The original Layer3 switch uses this information to build its own routing table
- 4) Then, as part of the regular update, Layer3 switch sends link-state advertisement (LSA) packets to its neighboring Layer3 switches. The LSA includes links and related costs of that Layer3 switch.
- 5) Each neighboring Layer3 switch copies the LSA packet and passes it to the next neighbor (i.e. flooding).
- 6) Since routing database is not recalculated before Layer3 switch forwards LSA flooding, the converging time is greatly reduced.

---

One major advantage of link-state routing protocols is the fact that infinite counting is impossible; this is because the way link-state routing protocols build up their routing table. The second advantage is that converging in a link-state interconnected network is very fast, once the routing topology changes, updates will be flooded throughout the network very soon. Those advantages release some Layer3 switch resources, as the process ability and bandwidth used by bad route information are minor.

The features of OSPF protocol include the following: OSPF supports networks of various scales, several hundreds of Layer3 switches can be supported in an OSPF network. Routing topology changes can be quickly found and updated LSAs can be sent immediately, so that routes converge quickly. Link-state information is used in the shortest path algorithm for route calculation, eliminating loop route. OSPF divides the autonomous system into areas, reducing database size, bandwidth occupation and calculation load. (According to the position of Layer3 switches in the autonomous system, they can be grouped as internal area switches, area border switches, border switches and backbone switches). OSPF supports load balance and multiple routes to the same destination of equal costs. OSPF supports 4 level routing mechanisms (process routing according to the order of intra-area path, inter-area path, type 1 external path and type 2 external path). OSPF supports IP subnet and redistribution of routes from the other routing protocols, and interface-based packet verification. OSPF supports sending packets in multicast.

Each OSPF Layer3 switch maintains a database describing the topology of the whole autonomous system. Each Layer3 switch gathers the local status information, such as available interface, reachable neighbors, and sends link-state advertisement (sending out link-state information) to exchange link-state information with other OSPF Layer3 switches to form a link-state database describing the whole autonomous system. Each Layer3 switch builds a shortest path tree rooted by itself according to the link-state database. This tree provides the routes to all nodes in an autonomous system. If two or more Layer3 switches exist (i.e. multi-access network), "designated Layer3 switch" and "backup designated Layer3 switch" will be selected. Designated Layer3 switch is responsible for spreading link-state of the network. This concept helps reduce the traffic among the Layer3 switches in multi-access network.

OSPF protocol requires the autonomous system to be divided into areas. That is to divide the autonomous system into 0 area (backbone area) and non-0 areas. Routing information between areas are further abstracted and summarized to reduce the bandwidth required in the network. OSPF uses four different kinds of routes and they are intra-area route, inter-area route, type 1 external route and type 2 external route, in the order of the highest priority to the lowest. The route inside an area and between areas describes the internal network structure of an autonomous system, while external routes describe how to select the routing information to destination outside the autonomous system. The first type of exterior route corresponds to the information introduced by OSPF from the other interior routing protocols, the costs of those routes are comparable with the costs of OSPF routes; the second type of exterior route corresponds to the information introduced by OSPF from the other exterior routing protocols, but the costs of those routes are far greater than that of OSPF routes, so OSPF route cost is ignored when calculating route costs.

OSPF areas are centered with the Backbone area, identified as Area 0, all the other areas must be connected to Area 0 logically, and Area 0 must be continuous. For this reason, the concept of virtual link is introduced to the backbone area, so that physically separated areas still have logical connectivity to the backbone area. The configurations of all the Layer3 switches in the same area must be the same.



---

In conclusion, LSA can only be transferred between neighboring Layer3 switches, OSPF protocol includes 5 types of LSA: router LSA, network LSA, network summary LSA to the other areas, ASBR summary LSA and AS external LSA. They can also be called type1 LSA, type2 LSA, type3 LSA, type4 LSA, and type5 LSA. Router LSA is generated by each Layer3 switch inside an OSPF area, and is sent to all the other neighboring Layer3 switches in the same area; network LSA is generated by the designated Layer3 switch in the OSPF area of multi-access network, and is sent to all other neighboring Layer3 switches in this area. (In order to reduce traffic on Layer3 switches in the multi-access network, “designated Layer3 switch” and “backup designated Layer3 switch” should be selected in the multi-access network, and the network link-state is broadcasted by the designated Layer3 switch); network summary LSA is generated by border switches in an OSPF area, and is transferred among area border Layer3 switches; AS external LSA is generated by Layer3 switches on external border of AS, and is transferred throughout the AS.

As to autonomous systems mainly advertises exterior link-state, OSPF allow some areas to be configured as STUB areas to reduce the size of the topology database. Type4 LSA (ASBR summary LSA) and type5 LSA (AS external LSA) are not allowed to flood into/through STUB areas. STUB areas must use the default routes, the Layer3 switches on STUB area edge advertise the default routes to STUB areas by type 3 summary LSA, those default routes only floods inside STUB area and will not get out of STUB area. Each STUB area has a corresponding default route, the route from a STUB area to AS exterior destination must rely on the default route of that area.

The following simply outlines the route calculation process of OSPF protocol:

- 1) Each OSPF-enabled Layer3 switch maintains a database (LS database) describing the link-state of the topology structure of the whole autonomous system. Each Layer3 switch generates a link-state advertisement according to its surrounding network topology structure (router LSA), and sends the LSA to other Layer3 switches through link-state update (LSU) packets. Thus each Layer3 switch receives LSAs from other Layer3 switches, and all LSAs are combined to the link-state database.
- 2) Since an LSA is the description of the network topology structure around a Layer3 switch, the LS database is the description of the network topology structure of the whole network. The Layer3 switches can easily create a weighted vector map according to the LS database. Obviously, all Layer3 switches in the same autonomous system will have the same network topology map.
- 3) Each Layer3 switch uses the shortest path first (SPF) algorithm to calculate a tree of shortest path rooted by itself. The tree provides the route to all the nodes in the autonomous system, leaf nodes consist of the exterior route information. The exterior route can be marked by the Layer3 switch that broadcasts it, so that additional information about the autonomous system can be recorded. As a result, the route table of each Layer3 switch is different.

OSPF protocol is developed by the IETF. The OSPF v2 widely used now is fulfilled according to the content described in RFC2328.

---

## 38.2 OSPF Configuration Task List

The OSPF configuration for SGS-6341 Series switch may be different from the configuration procedure to switches of the other manufacturers. It is a two-step process:

1) Enable OSPF in the Global Mode; 2) Configure OSPF area for the interfaces. The configuration task list is as follows:

1. Enable OSPF protocol (required)
  - (1) Enable/disable OSPF protocol (required)
  - (2) Configure the ID number of the layer3 switch running OSPF (optional)
  - (3) Configure the network scope for running OSPF (optional)
  - (4) Configure the area for the interface (required)
2. Configure OSPF protocol parameters (optional)
  - (1) Configure OSPF packet sending mechanism parameters
    - 1) Configure OSPF packet verification
    - 2) Set the OSPF interface to receive only
    - 3) Configure the cost for sending packets from the interface
    - 4) Configure OSPF packet sending timer parameter (timer of broadcast interface sending HELLO packet to poll, timer of neighboring layer3 switch invalid timeout, timer of LSA transmission delay and timer of LSA retransmission.
  - (2) Configure OSPF route introduction parameters
    - 1) Configure default parameters (default type, default tag value, default cost)
    - 2) Configure the routes of the other protocols to introduce to OSPF.
  - (3) Configure OSPF importing the routes of other OSPF processes
    - 1) Enable the function of OSPF importing the routes of other OSPF processes
    - 2) Display relative information
    - 3) Debug
  - (4) Configure other OSPF protocol parameters
    - 1) Configure OSPF routing protocol priority
    - 2) Configure cost for OSPF STUB area and default route
    - 3) Configure OSPF virtual link
    - 4) Configure the priority of the interface when electing designated layer3 switch (DR).
    - 5) Configure to keep a log for OSPF adjacency changes or not
3. Disable OSPF protocol

### 1. Enable OSPF protocol

Basic configuration of OSPF routing protocol on switch is quite simple, usually only enabling OSPF and configuration of the OSPF area for the interface are required. The OSPF protocol parameters can use the default settings. If OSPF protocol parameters need to be modified, please refer to "2. Configure OSPF protocol parameters".

Command	Explanation
Global Mode	
<b>[no] router ospf [process &lt;id&gt;]</b>	Enables OSPF protocol; the “ <b>no router ospf</b> ” command disables OSPF protocol. (required)
OSPF Protocol Configuration Mode	
<b>router-id &lt;router_id&gt;</b> <b>no router-id</b>	Configures the ID number for the layer3 switch running OSPF; the “ <b>no router id</b> ” command cancels the ID number. The IP address of an interface is selected to be the layer3 switch ID. (optional)
<b>[no] network {&lt;network&gt; &lt;mask&gt; / &lt;network&gt;/&lt;prefix&gt;} area &lt;area_id&gt;</b>	Configure certain segment to certain area, the no <b>[no] network {&lt;network&gt; &lt;mask&gt; / &lt;network&gt;/&lt;prefix&gt;} area &lt;area_id&gt;</b> command cancels this configuration. (required)

## 2. Configure OSPF protocol parameters

### (1) Configure OSPF packet sending mechanism parameters

- 1) Configure OSPF packet verification
- 2) Set the OSPF interface to receive only
- 3) Configure the cost for sending packets from the interface

Command	Explanation
Interface Configuration Mode	
<b>ip ospf authentication</b> <b>{ message-digest   null}</b> <b>no ip ospf authentication</b>	Configures the authentication method by the interface to accept OSPF packets; the <b>no ip ospf authentication</b> command restores the default settings.
<b>ip ospf authentication-key LINE</b> <b>no ip ospf authentication-key</b>	Configure the key of the authentication process of OSPF data packets receiving for the interfaces; the no action of this command restores the default settings.
<b>[no] passive-interface &lt;ifname&gt;</b> <b>[&lt;ip-address&gt;]</b>	Sets an interface to receive only, the <b>no passive-interface &lt;ifname&gt;[&lt;ip-address&gt;]</b> command cancels this configuration.
<b>ip ospf cost &lt;cost &gt;</b> <b>no ip ospf cost</b>	Sets the cost for running OSPF on the interface; the <b>no ip ospf cost</b> command restores the default setting.

4) Configure OSPF packet sending timer parameter (timer of broadcast interface sending HELLO packet to poll, timer of neighboring layer3 switch invalid timeout, timer of LSA transmission delay and timer of LSA retransmission).

Command	Explanation
Interface Configuration Mode	
<b>ip ospf hello-interval &lt;time&gt;</b> <b>no ip ospf hello-interval</b>	Sets interval for sending HELLO packets; the “ <b>no ip ospf hello-interval</b> ” command restores the default setting.
<b>ip ospf dead-interval &lt;time &gt;</b> <b>no ip ospf dead-interval</b>	Sets the interval before regarding a neighbor layer3 switch invalid; the “ <b>no ip ospf dead-interval</b> ” command restores the default setting.
<b>ip ospf transit-delay &lt;time&gt;</b> <b>no ip ospf transit-delay</b>	Sets the delay time before sending link-state broadcast; the “ <b>no ip ospf transmit-delay</b> ” command restores the default setting.
<b>ip ospf retransmit &lt;time&gt;</b> <b>no ip ospf retransmit</b>	Sets the interval for retransmission of link-state advertisement among neighbor layer3 switches; the “ <b>no ip ospf retransmit</b> ” command restores the default setting.

## (2) Configure OSPF route introduction parameters

Configure the routes of the other protocols to introduce to OSPF.

Command	Explanation
OSPF Protocol Configuration Mode	
<b>redistribute { bgp   connected   static   rip   kernel} [ metric-type { 1   2 } ] [ tag &lt;tag&gt; ] [ metric &lt;cost_value&gt; ] [router-map &lt;WORD&gt;]</b> <b>no redistribute { bgp   connected   static   rip   kernel }</b>	Distribute other protocols to find routing and static routings as external routing messages the <b>no redistribute {bgp   connected   static   rip   kernel}</b> command cancels the distributed external messages.

## (3) Configure OSPF importing the routes of other OSPF processes

1) Enable the function of OSPF importing the routes of other OSPF processes

Command	Explanation
Router OSPF Mode	
<b>redistribute ospf [&lt;process-id&gt;] [metric&lt;value&gt;] [metric-type {1 2}][route-map&lt;word&gt;]</b> <b>no redistribute ospf [&lt;process-id&gt;] [metric&lt;value&gt;] [metric-type {1 2}][route-map&lt;word&gt;]</b>	Enable or disable the function of OSPF importing the routes of other OSPF processes.

2) Display relative information

Command	Explanation
Admin Mode or Configure Mode	
<b>show ip ospf [<i>&lt;process-id&gt;</i> redistribute</b>	Display the configuration information of the OSPF process importing other outside routes.

3) Debug

Command	Explanation
Admin Mode	
<b>debug ospf redistribute message send no debug ospf redistribute message send debug ospf redistribute route receive no debug ospf redistribute route receive</b>	Enable or disable debugging of sending command from OSPF process redistributed to other OSPF process routing. Enable or disable debugging of received routing message from NSM for OSPF process.

(4) Configure other OSPF protocol parameters

- 1) Configure how to calculate OSPF SPF algorithm time
- 2) Configure the LSA limit in the OSPF link state database
- 3) Configure various OSPF parameters

Command	Explanation
OSPF Protocol Configuration Mode	
<b>timers spf <i>&lt;interval&gt;</i> no timers spf</b>	Configure the SPF timer of OSPF; the <b>no timers spf</b> command restores the default settings.
<b>overflow database {<i>&lt;max-LSA&gt;</i> [hard   soft]   external <i>&lt;max-LSA&gt;</i> <i>&lt;recover time&gt;</i>} no overflow database [external <i>&lt;max-LSA&gt;</i> <i>&lt;recover time&gt;</i>]</b>	Configure the LSA limit in current OSPF process database; the <b>no overflow database [external <i>&lt;max-LSA&gt;</i> <i>&lt;recover time&gt;</i>]</b> command restores the default settings.
<b>area <i>&lt;id&gt;</i> {authentication [message-digest]   default-cost <i>&lt;cost&gt;</i>   filter-list {access   prefix} <i>&lt;WORD&gt;</i> {in   out}   nssa [default-information-originate   no-redistribution   no-summary   translator-role]   range <i>&lt;range&gt;</i>   stub [no-summary]   virtual-link <i>&lt;neighbor&gt;</i>} no area <i>&lt;id&gt;</i> {authentication   default-cost   filter-list {access   prefix} <i>&lt;WORD&gt;</i> {in   out}   nssa [default-information-originate   no-redistribution   no-summary   translator-role]   range <i>&lt;range&gt;</i>   stub [no-summary]   virtual-link <i>&lt;neighbor&gt;</i>}</b>	Configure the parameters in OSPF area (STUB area, NSSA area and virtual links); the <b>no area <i>&lt;id&gt;</i> {authentication   default-cost   filter-list {access   prefix} <i>&lt;WORD&gt;</i> {in   out}   nssa [default-information-originate   no-redistribution   no-summary   translator-role]   range <i>&lt;range&gt;</i>   stub [no-summary]   virtual-link <i>&lt;neighbor&gt;</i>}</b> command restores the default settings.

---

4) Configure the priority of the interface when electing designated layer3 switch (DR).

Command	Explanation
Interface Configuration Mode	
<b>ip ospf priority &lt;priority&gt;</b> <b>no ip ospf priority</b>	Sets the priority of the interface in “designated layer3 switch” election; the <b>no ip ospf priority</b> command restores the default setting.

5) Configure to keep a log for OSPF adjacency changes or not

Command	Explanation
OSPF Protocol Configuration Mode	
<b>log-adjacency-changes detail</b> <b>no log-adjacency-changes detail</b>	Configure to keep a log for OSPF adjacency changes or not.

5) Filter the route obtained by OSPF

Command	Explanation
OSPF Protocol Configuration Mode	
<b>filter-policy &lt;access-list-name&gt;</b> <b>no filter-policy</b>	Use access list to filter the route obtained by OSPF, the no command cancels the route filtering.

### 3. Disable OSPF protocol

Command	Explanation
Global Mode	
<b>no router ospf [process &lt;id&gt;]</b>	Disables OSPF routing protocol.

## 38.3 OSPF Examples

### 38.3.1 Configuration Example of OSPF

**Scenario 1:** OSPF autonomous system.

This scenario takes an OSPF autonomous system consists of five switch for example.

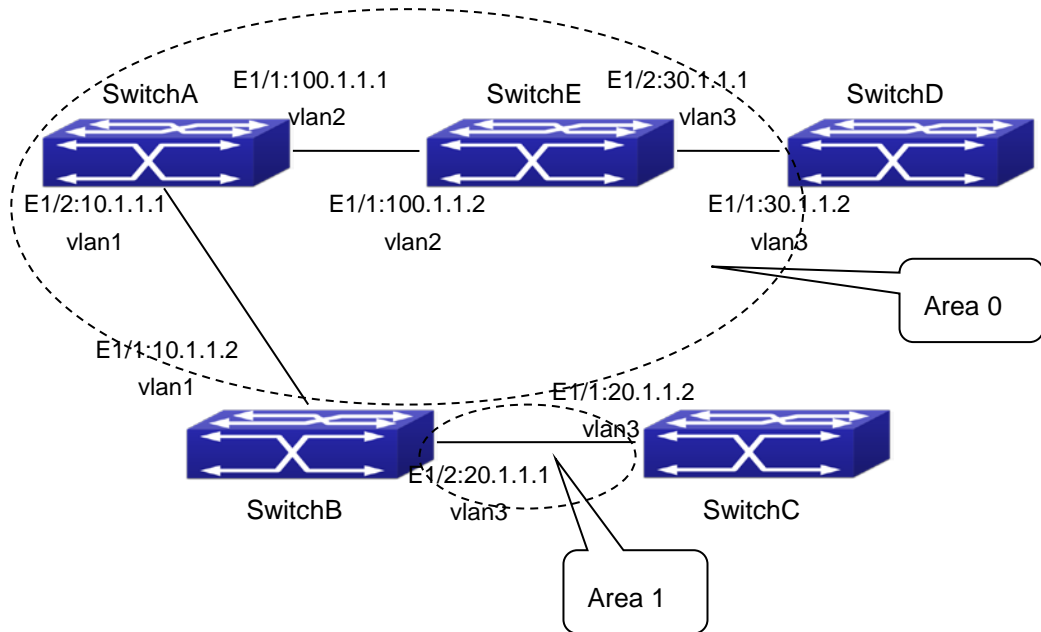

**Figure 38-1** Network topology of OSPF autonomous system

The configuration for layer3 Switch1 and Switch5 is shown below:

### Layer 3 Switch1

#### Configuration of the IP address for interface vlan1

```
Switch1#config
Switch1(config)# interface vlan 1
Switch1(config-if-vlan1)# ip address 10.1.1.1 255.255.255.0
Switch1(config-if-vlan1)#exit
Configuration of the IP address for interface vlan2
Configure the IP address of interface vlan2
Switch1(config)# interface vlan 2
Switch1(config-if-vlan2)# ip address 100.1.1.1 255.255.255.0
Switch1 (config-if-vlan2)#exit
```

Enable OSPF protocol, configure the area number for interface vlan1 and vlan2.

```
Switch1(config)#router ospf
Switch1(config-router)#network 10.1.1.0/24 area 0
Switch1(config-router)#network 100.1.1.0/24 area 0
Switch1(config-router)#exit
Switch1(config)#exit
Switch1#
```

---

### Layer 3 Switch2:

#### Configure the IP address for interface vlan1 and vlan2.

```
Switch2#config
Switch2(config)# interface vlan 1
Switch2(config-if-vlan1)# ip address 10.1.1.2 255.255.255.0
Switch2(config-if-vlan1)#no shutdown
Switch2(config-if-vlan1)#exit
Switch2(config)# interface vlan 3
Switch2(config-if-vlan3)# ip address 20.1.1.1 255.255.255.0
Switch2(config-if-vlan3)#no shutdown
Switch2(config-if-vlan3)#exit
```

Enable OSPF protocol, configure the OSPF area interfaces vlan1 and vlan3 in

```
Switch2(config)#router ospf
Switch2(config-router)# network 10.1.1.0/24 area 0
Switch2(config-router)# network 20.1.1.0/24 area 1
Switch2(config-router)#exit
Switch2(config)#exit
Switch2#
```

### Layer 3 Switch3:

#### Configuration of the IP address for interface vlan3.

```
Switch3#config
Switch3(config)# interface vlan 3
Switch3(config-if-vlan1)# ip address 20.1.1.2 255.255.255.0
Switch3(config-if-vlan3)#no shutdown
Switch3(config-if-vlan3)#exit
```

Initiate the OSPF protocol, configure the OSPF area to which interface vlan3 belongs

```
Switch3(config)#router ospf
Switch3(config-router)# network 20.1.1.0/24 area 1
Switch3(config-router)#exit
Switch3(config)#exit
Switch3#
```



---

### Layer 3 Switch4:

#### Configuration of the IP address for interface vlan3

```
Switch4#config
Switch4(config)# interface vlan 3
Switch4(config-if-vlan3)# ip address 30.1.1.2 255.255.255.0
Switch4(config-if-vlan3)#no shutdown
Switch4(config-if-vlan3)#exit
```

Enable OSPF protocol, configure the OSPF area interfaces vlan3 resides in. Switch4(config)#router ospf

```
Switch4(config-router)# network 30.1.1.0/24 area 0
Switch4(config-router)#exit
Switch4(config)#exit
Switch4#
```

### Layer 3 Switch5:

#### Configuration of the IP address for interface vlan2

```
Switch5#config
Switch5(config)# interface vlan 2
Switch5(config-if-vlan2)# ip address 100.1.1.2 255.255.255.0
Switch5(config-if-vlan2)#no shutdown
Switch5(config-if-vlan2)#exit
```

#### Configuration of the IP address for interface vlan3

```
Switch5(config)# interface vlan 3
Switch5(config-if-vlan3)# ip address 30.1.1.1 255.255.255.0
Switch5(config-if-vlan3)#no shutdown
Switch5(config-if-vlan3)#exit
```

Enable OSPF protocol, configure the number of the area in which interface vlan2 and vlan3 reside in.

```
Switch5(config)#router ospf
Switch5(config-router)# network 30.1.1.0/24 area 0
Switch5(config-router)# network 100.1.1.0/24 area 0
Switch5(config-router)#exit
Switch5(config)#exit
Switch5#
```

**Scenario 2:** Typical OSPF protocol complex topology.

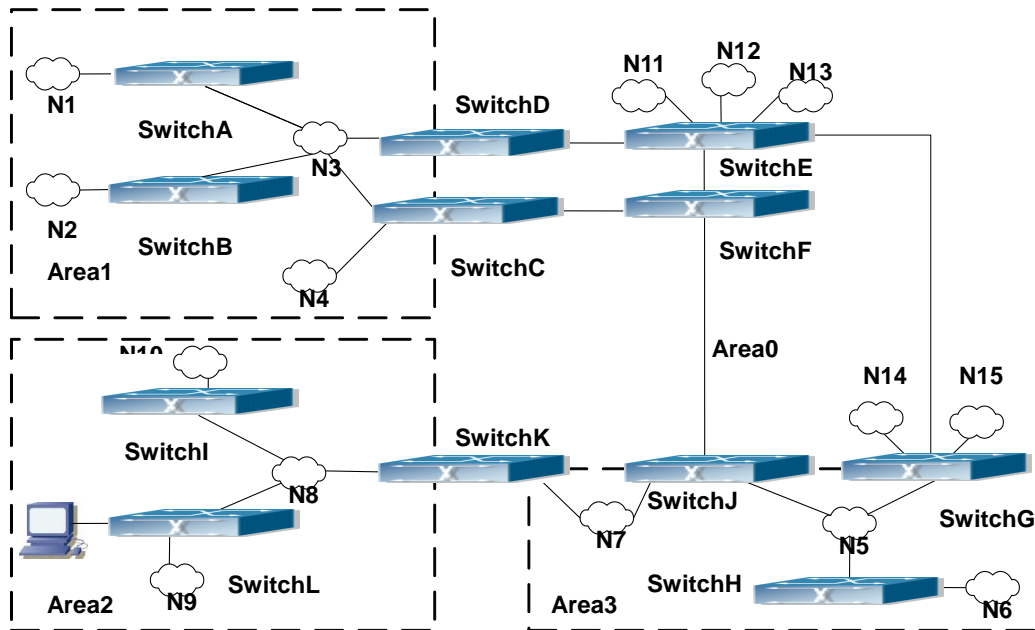

**Figure 38-2** Typical complex OSPF autonomous system

This scenario is a typical complex OSPF autonomous system network topology. Area1 include network N1-N4 and layer3 SwitchA-SwitchD, area2 include network N8-N10, host H1 and layer3 SwitchH, area3 include N5-N7 and Layer3 SwitchF, SwitchG SwitchA0 and Switch11, and network N8-N10 share a summary route with host H1(i.e. area3 is defined as a STUB area). Layer3 SwitchA, SwitchB, SwitchD, SwitchE, SwitchG, SwitchH, Switch12 are in-area Layer3 switches, SwitchC, SwitchD, SwitchF, Switch10 and Switch11 are edge layer3 switches of the area, SwitchD and SwitchF are edge layer3 switches of the autonomous system. To area1, Layer3 switches SwitchA and SwitchB are both in-area switches, area edge switches SwitchC and SwitchD are responsible for reporting distance cost to all destination outside the area, while they are also responsible for reporting the position of the AS edge Layer3 switches SwitchD and SwitchF, AS exterior link-state advertisement from SwitchD and SwitchF are flooded throughout the whole autonomous system. When ASE LSA floods in area 1, those LSAs are included in the area 1 database to get the routes to network N11 and N15.

In addition, Layer3 SwitchC and SwitchD must summary the topology of area 1 to the backbone area (area 0, all non-0 areas must be connected via area 0, direct connections are not allowed), and advertise the networks in area 1 (N1-N4) and the costs from SwitchC and SwitchD to those networks. As the backbone area is required to keep connected, there must be a virtual link between backbone layer3 Switch10 and Switch11. The area edge Layer3 switches exchange summary information via the backbone Layer3 switch, each area edge Layer3 switch listens to the summary information from the other edge layer3 switches.

Virtual link can not only maintain the connectivity of the backbone area, but also strengthen the backbone area. For example, if the connection between backbone Layer3 SwitchG and Switch10 is cut down, the backbone area will become in continuous. The backbone area can become more robust by establishing a virtual link between backbone Layer3 switches SwitchF and Switch10. In addition, the virtual link between SwitchF and Switch10 provide a short path from area 3 to Layer3 SwitchF.

---

Take area 1 as an example. Assume the IP address of Layer3 SwitchA is 10.1.1.1, IP address of Layer3 SwitchB interface VLAN2 is 10.1.1.2, IP address of Layer3 SwitchC interface VLAN2 is 10.1.1.3, IP address of Layer3 SwitchD interface VLAN2 is 10.1.1.4. SwitchA is connecting to network N1 through Ethernet interface VLAN1 (IP address 20.1.1.1); SwitchB is connecting to network N2 through Ethernet interface VLAN1 (IP address 20.1.2.1); SwitchC is connecting to network N4 through Ethernet interface VLAN3 (IP address 20.1.3.1). All the three addresses belong to area 1. SwitchC is connecting to Layer3 SwitchE through Ethernet interface VLAN1 (IP address 10.1.5.1); SwitchD is connecting to Layer3 SwitchD through Ethernet interface VLAN1 (IP address 10.1.6.1); both two addresses belong to area 1. Simple authentication is implemented among Layer3 switches in area1, edge layer3 switches of area 1 authenticate with the area 0 backbone layer3 switches by MD5 authentication.

The followings are just configurations for all Layer3 switches in area 1, configurations for Layer3 switches of the other areas are omitted. The following are the configurations of SwitchA, SwitchB, SwitchC and SwitchD:

### 1)SwitchA:

Configure IP address for interface vlan2

```
SwitchA#config
SwitchA(config)# interface vlan 2
SwitchA(config-If-Vlan2)# ip address 10.1.1.1 255.255.255.0
SwitchA(config-If-Vlan2)#exit
```

Enable OSPF protocol, configure the area number for interface vlan2.

```
SwitchA(config)#router ospf
SwitchA(config-router)#network 10.1.1.0/24 area 1
SwitchA(config-router)#exit
```

Configure simple key authentication.

```
SwitchA(config)#interface vlan 2
SwitchA(config-If-Vlan2)#ip ospf authentication
SwitchA(config-If-Vlan2)#ip ospf authentication-key DCS
SwitchA(config-If-Vlan2)#exit
```

Configure IP address and area number for interface vlan1.

```
SwitchA(config)# interface vlan 1
SwitchA(config-If-Vlan1)#ip address 20.1.1.1 255.255.255.0
SwitchA(config-If-Vlan1)#exit
SwitchA(config)#router ospf
SwitchA(config-router)#network 20.1.1.0/24 area 1
SwitchA(config-router)#exit
```

---

## 2)SwitchB:

Configure IP address for interface vlan2

```
SwitchB#config
SwitchB(config)# interface vlan 2
SwitchB(config-If-Vlan2)# ip address 10.1.1.2 255.255.255.0
SwitchB(config-If-Vlan2)#exit
```

Enable OSPF protocol, configure the area number for interface vlan2.

```
SwitchB(config)#router ospf
SwitchB(config-router)#network 10.1.1.0/24 area 1
SwitchB(config-router)#exit
SwitchB(config)#interface vlan 2
```

Configure simple key authentication.

```
SwitchB(config)#interface vlan 2
SwitchB(config-If-Vlan2)#ip ospf authentication
SwitchB(config-If-Vlan2)#ip ospf authentication-key DCS
SwitchB(config-If-Vlan2)#exit
```

Configure IP address and area number for interface vlan1.

```
SwitchB(config)# interface vlan 1
SwitchB(config-If-Vlan1)#ip address 20.1.2.1 255.255.255.0
SwitchB(config-If-Vlan1)#exit
SwitchB(config)#router ospf
SwitchB(config-router)#network 20.1.2.0/24 area 1
SwitchB(config-router)#exit
SwitchB(config)#exit
```

## 3)SwitchC:

Configure IP address for interface vlan2

```
SwitchC#config
SwitchC(config)# interface vlan 2
SwitchC(config-If-Vlan2)# ip address 10.1.1.3 255.255.255.0
SwitchC(config-If-Vlan2)#exit
```

Enable OSPF protocol, configure the area number for interface vlan2

```
SwitchC(config)#router ospf
SwitchC(config-router)#network 10.1.1.0/24 area 1
SwitchC(config-router)#exit
```

---

Configure simple key authentication

```
SwitchC(config)#interface vlan 2
SwitchC(config-If-Vlan2)#ip ospf authentication
SwitchC(config-If-Vlan2)#ip ospf authentication-key DCS
SwitchC(config-If-Vlan2)#exit
```

Configure IP address and area number for interface vlan3

```
SwitchC(config)# interface vlan 3
SwitchC(config-If-Vlan3)#ip address 20.1.3.1 255.255.255.0
SwitchC(config-If-Vlan3)#exit
SwitchC(config)#router ospf
SwitchC(config-router)#network 20.1.3.0/24 area 1
SwitchC(config-router)#exit
```

Configure IP address and area number for interface vlan 1

```
SwitchC(config)# interface vlan 1
SwitchC(config-If-Vlan1)#ip address 10.1.5.1 255.255.255.0
SwitchC(config-If-Vlan1)#exit
SwitchC(config)#router ospf
SwitchC(config-router)#network 10.1.5.0/24 area 0
SwitchC(config-router)#exit
```

Configure MD5 key authentication.

```
SwitchC(config)#interface vlan 1
SwitchC (config-If-Vlan1)#ip ospf authentication message-digest
SwitchC (config-If-Vlan1)#ip ospf authentication-key DCS
SwitchC (config-If-Vlan1)#exit
SwitchC(config)#exit
SwitchC#
```

#### 4)SwitchD:

Configure IP address for interface vlan2

```
SwitchD#config
SwitchD(config)# interface vlan 2
SwitchD(config-If-Vlan2)# ip address 10.1.1.4 255.255.255.0
SwitchD(config-If-Vlan2)#exit
```

Enable OSPF protocol, configure the area number for interface vlan2.

```
SwitchD(config)#router ospf
SwitchD(config-router)#network 10.1.1.0/24 area 1
SwitchD(config-router)#exit
```

Configure simple key authentication.

```
SwitchD(config)#interface vlan 2
SwitchD(config-lf-Vlan2)#ip ospf authentication
SwitchD(config-lf-Vlan2)#ip ospf authentication-key DCS
SwitchD(config-lf-Vlan2)#exit
```

Configure the IP address and the area number for the interface vlan 1

```
SwitchD(config)# interface vlan 1
SwitchD(config-lf-Vlan1)# ip address 10.1.6.1 255.255.255.0
SwitchD(config-lf-Vlan1)#exit
SwitchD(config)#router ospf
SwitchD(config-router)#network 10.1.6.0/24 area 0
SwitchD(config-router)#exit
```

Configure MD5 key authentication

```
SwitchD(config)#interface vlan 1
SwitchD(config-lf-Vlan1)#ip ospf authentication message-digest
SwitchD(config-lf-Vlan1)#ip ospf authentication-key DCS
SwitchD(config-lf-Vlan1)#exit
SwitchD(config)#exit
SwitchD#
```

**Scenario 3:** The function of OSPF importing the routers of other OSPF processes

As shown in the following graph, a switch running the OSPF routing protocol connects two networks: network A and network B. Because of some reason, it is required that network A should be able to learn the routers of network B, but network B should not be able to learn the routers of network A. According to that, two OSPF processes can be started respectively on interface vlan 1 and interface vlan 2. the OSPF process which interface vlan 1 belongs to is configured to import the routers of the OSPF process which interface vlan 2 belongs to, while the OSPF process which interface vlan 2 belongs to should not be configured to import the routers of the OSPF process which interface vlan 1 belongs to.

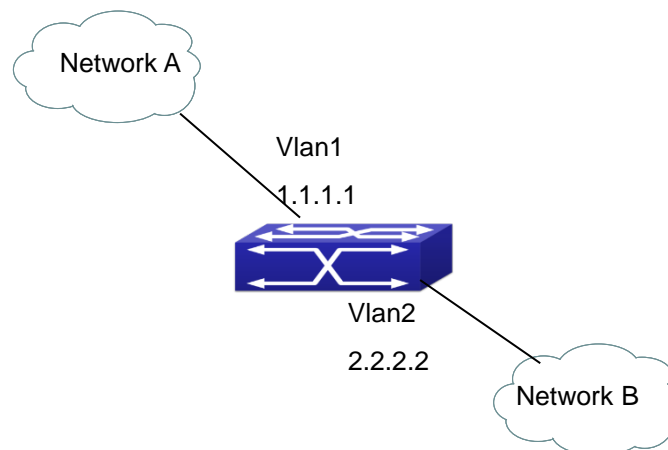
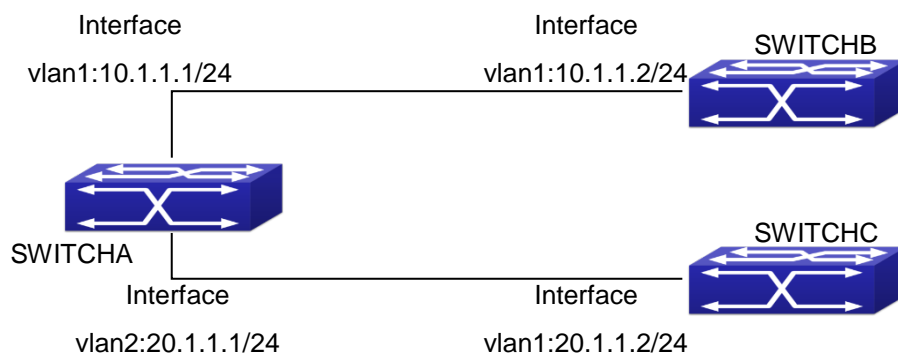

**Figure 38-3** Function of OSPF importing the routers of other OSPF processes example

We can configure as follows:

```
Switch(config)#interface vlan 1
Switch(Config-if-Vlan1)#ip address 1.1.1.1 255.255.255.0
Switch(Config-if-Vlan1)#exit
Switch(config)#interface vlan 2
Switch(Config-if-Vlan2)#ip address 2.2.2.2 255.255.255.0
Switch(Config-if-Vlan2)#exit
Switch(config)#router ospf 10
Switch(config-router)#network 2.2.2.0/24 area 1
Switch(config-router)#exit
Switch(config)#router ospf 20
Switch(config-router)#network 1.1.1.0/24 area 1
Switch(config-router)#redistribute ospf 10
Switch(config-router)#exit
```

### 38.3.2 Configuration Examples of OSPF VPN



**Figure 38-4** OSPF VPN Example

The above figure shows that a network consists of three Layer 3 switches in which the switchA as PE, SwitchB and SwitchC as CE1 and CE2. The PE is connected to CE1 and CE2 through vlan1 and vlan2. The routing messages are exchanged between PE and CE through OSPF protocol.

#### a) SwitchA, the Layer 3 switch as PE

Configure VPN route/transmitting examples vpnb and vpnc

```
SwitchA#config
SwitchA(config)#ip vrf vpnb
SwitchA(config-vrf)#
SwitchA(config-vrf)#exit
SwitchA#(config)
SwitchA(config)#ip vrf vpnc
SwitchA(config-vrf)#
SwitchA(config-vrf)#exit
```

---

Associate the vlan 1 and vlan 2 respectively with vpnb and vpnc while configuring IP address

```
SwitchA(config)#in vlan1
SwitchA(config-if-Vlan1)#ip vrf forwarding vpnb
SwitchA(config-if-Vlan1)#ip address 10.1.1.1 255.255.255.0
SwitchA(config-if-Vlan1)#exit
SwitchA(config)#in vlan2
SwitchA(config-if-Vlan2)#ip vrf forwarding vpnc
SwitchA(config-if-Vlan2)#ip address 20.1.1.1 255.255.255.0
SwitchA(config-if-Vlan2)#exit
```

Configure OSPF examples associated with vpnb and vpnc respectively

```
SwitchA(config)#
SwitchA(config)#router ospf 100 vpnb
SwitchA(config-router)#network 10.1.1.0/24 area 0
SwitchA(config-router)#redistribute bgp
SwitchA(config-router)#exit
SwitchA(config)#router ospf 200 vpnc
SwitchA(config-router)#network 20.1.1.0/24 area 0
SwitchA(config-router)#redistribute bgp
```

**b) The Layer 3 SwitchB of CE1 :**

Configure the IP address of Ethernet E 1/0/2

```
SwitchB#config
SwitchB(config)# interface Vlan1
SwitchB(config-if-vlan1)# ip address 10.1.1.2 255.255.255.0
SwitchB (config-if-vlan1)exit
```

Enable OSPF protocol and configuring OSPF segments

```
SwitchB(config)#router ospf
SwitchB(config-router-rip)#network 10.1.1.0/24 area 0
SwitchB(config-router-rip)#exit
```

**c) The Layer 3 SwitchC of CE2**

Configure the IP address of Ethernet E 1/0/2

```
SwitchC#config
SwitchC(config)# interface Vlan1
SwitchC(config-if-vlan1)# ip address 20.1.1.2 255.255.255.0
SwitchC(config-if-vlan1)#exit
```



---

Initiate OSPF protocol and configuring OSPF segments

```
SwitchC(config)#router ospf
SwitchC(config-router)#network 20.1.1.0/24 area 0
SwitchC(config-router)#exit
```

## 38.4 OSPF Troubleshooting

The OSPF protocol may not be working properly due to errors such as physic connection, configuration error when configuring and using the OSPF protocol. So users should pay attention to following:

- First ensure the physic connection is correct
- Second, ensure the interface and link protocol are UP (use **show interface** command)
- Configure different IP address from different segment on each interface
- Then initiate OSPF protocol (use **router-ospf** command) and configure the OSPF area on corresponding interface
- After that, a OSPF protocol feature should be checked---the OSPF backbone area should be continuous and apply virtual link to ensure it is continuous. if not; all non 0 areas should only be connected to other non 0 area through 0 area; a border Layer 3 switch means that one part of the interfaces of this switch belongs to 0 area, the other part belongs to non 0 area; Layer 3 switch DR should be specified for multi-access network such as broadcast network.

---

# Chapter 39 OSPFv3

## 39.1 Introduction to OSPFv3

OSPFv3 (Open Shortest Path First) is the third version for Open Shortest Path First, and it is the IPv6 version of OSPF Protocol. It is an interior dynamic routing protocol for autonomous system based on link-state. The protocol creates a link-state database by exchanging link-states among layer3 switches, and then uses the Shortest Path First algorithm to generate a route table basing on that database.

Autonomous system (AS) is a self-managed interconnected network. In large networks, such as the Internet, a giant interconnected network is broken down to autonomous systems. Big enterprise networks connecting to the Internet are independent AS, since the other hosts on the Internet are not managed by those AS and they don't share interior routing information with the layer3 switches on the Internet.

Each link-state layer3 switch can provide information about the topology with its neighboring layer3 switches.

- The network segment (link) connecting to the layer3 switch
- State of the connecting link

Link-state information is flooded throughout the network so that all Layer3 switches can get first hand information. Link-state Layer3 switches will not broadcast all information contained in their route tables; instead, they only send changed link-state information. Link-state Layer3 switches establish neighborhood by sending "HELLO" to their neighbors, then link-state advertisements (LSA) will be sent among neighboring layer3 switches. Neighboring Layer3 switch copy the LSA to their routing table and transfer the information to the rest part of the network. This process is referred to as "flooding". In this way, firsthand information is sent throughout the network to provide accurate map for creating and updating routes in the network. Link-state routing protocols use cost instead of hops to decide the route. Cost is assigned automatically or manually. According to the algorithm in link-state protocol, cost can be used to calculate the hop number for packets to pass, link bandwidth, and current load of the link, the administrator can even add weight for better assessment of the link-state.

- 1) When a link-state Layer3 switch enters a link-state interconnected network, it sends a HELLO packet to get to know its neighbors and establish neighborhood.
- 2) The neighbors respond with information about the links they are connecting and the related costs.
- 3) The originate layer3 switch uses this information to build its own routing table.
- 4) Then, as part of the regular update, Layer3 switch send link-state advertisement (LSA) packets to its neighboring Layer3 switches. The LSA include links and related costs of that layer3 switch.
- 5) Each neighboring Layer3 switch copies the LSA packet and passes it to the next neighbor (i.e. flooding).
- 6) Since routing database is not recalculated before Layer3 switch forwards LSA flooding, the converging time is greatly reduced.

---

One major advantage of link-state routing protocols is the fact that infinite counting is impossible, this is because of the way link-state routing protocols build up their routing table. The second advantage is that converging in a link-state interconnected network is very fast, once the routing topology changes, updates will be flooded throughout the network very soon. Those advantages release some Layer3 switch resources, as the process ability and bandwidth used by bad route information are minor.

The features of OSPFv3 protocol include the following: OSPFv3 supports networks of various scales, several hundreds of Layer3 switches can be supported in an OSPFv3 network. Routing topology changes can be quickly found and updating LSAs can be sent immediately, so that routes converge quickly. Link-state information is used in shortest path algorithm for route calculation, eliminating loop route. OSPFv3 divides the autonomous system into areas, reducing database size, bandwidth occupation and calculation load. (According to the position of layer3 switches in the autonomous system, they can be grouped as internal area switches, area edge switches, edge switches and backbone switches). OSPFv3 supports load balance and multiple routes to the same destination of equal costs. OSPFv3 supports 4 level routing mechanisms (process routing according to the order of route inside an area, route between areas, type 1 external route and type 2 external route). OSPFv3 support IP subnet and redistribution of routes from the other routing protocols, and interface-based packet verification. OSPFv3 supports sending packets in multicast.

Each OSPFv3 layer3 switch maintains a database describing the topology of the whole autonomous system. Each layer3 switch gathers the local status information, such as available interface, reachable neighbors, and sends link-state advertisement (sending out link-state information) to exchange link-state information with other OSPFv3 layer3 switches to form a link-state database describing the whole autonomous system. Each layer3 switch builds a shortest path tree rooted by itself according to the link-state database, this tree provide the routes to all nodes in an autonomous system. If two or more layer3 switches exist (i.e. multi-access network), "designated layer3 switch" and "backup designated layer3 switch" will be selected. Designated layer3 switch is responsible for spreading link-state of the network. This concept helps reducing the traffic among the Layer3 switches in multi-access network.

OSPFv3 protocol requires the autonomous system to be divided into areas. That is to divide the autonomous system into 0 area (backbone area) and non-0 areas. Routing information between areas are further abstracted and summarized to reduce the bandwidth required in the network. OSPFv3 uses four different kinds of routes: they are the route inside the area, route between areas, type 1 external route and type 2 external route, in the order of highest priority to lowest. The route inside an area and between areas describe the internal network structure of an autonomous system, while external routes describe external routes describe how to select the routing information to destination outside the autonomous system. The first type of exterior route corresponds to the information introduced by OSPFv3 from the other interior routing protocols, the costs of those routes are comparable with the costs of OSPFv3 routes; the second type of exterior route corresponds to the information introduced by OSPFv3 from the other exterior routing protocols, but the costs of those routes are far greater than that of OSPFv3 routes, so OSPFv3 route cost is ignored when calculating route costs.

OSPFv3 areas are centered with the Backbone area, identified as the Area 0, all the other areas must be connected to Area 0 logically, and Area 0 must be continuous. For this reason, the concept of virtual link is introduced to the backbone area, so that physically separated areas still have logical connectivity to the backbone area. The configurations of all the layer3 switches in the same area must be the same.

---

In one word, LSA can only be transferred between neighboring Layer3 switches, and OSPFv3 protocol includes seven kinds of LSA: link LSA, internal-area prefix LSA, router LSA, network LSA, inter-area prefix LSA, inter-area router LSA and autonomous system exterior LSA. Router LSA is generated by each Layer 3 switch in an OSPF area, and is sent to all other neighboring Layer 3 switch in this area; network LSA is generated by designated Layer 3 switch in the OSPF area of multi-access network and is sent to all other neighboring layer3 switches in this area.(To reduce data traffic among each Layer 3 switches in the multi-access network, “designated layer3 switch” and “backup designated layer3 switch” should be selected in the multi-access network, and the network link-state is broadcasted by designated Layer 3 switch); the inter-area prefix LSA and inter-area router LSA are generated by OSPF area border Layer 3 switches and transferred among those switches. The autonomous system exterior LSA is generated by autonomous system exterior border Layer 3 switches and transferred in the whole autonomous system. Link LSA is generated by Layer 3 switch on the link and sent to other Layer 3 switches on the link. Internal-area prefix LSA is generated by designated layer3 switch of each link in this area, and flooded to the whole area.

For autonomous system focused on exterior link-state announcement, OSPFv3 allow some areas to be configured as STUB areas in order to reduce the size of topological database. Router LSA, network LSA, inter-area prefix LSA, link LSA, internal-area prefix LSA are permitted to advertise to STUB area. Default route must be used in STUB area, Layer 3 switches on the area border of STUB area announces to default routes of STUB area by inter-area prefix LSA; these default routes only flood in STUB area, not outside of STUB area. Each STUB area has a corresponding default route, the route from STUB area to AS exterior destination depends only on default route of this area.

The following simply outlines the route calculation process of OSPFv3 protocol:

1. Each OSPF-enabled layer3 switch maintains a database (LS database) describing the link-state of the topology structure of the whole autonomous system. Each layer3 switch generates a link-state advertisement according to its surrounding network topology structure (router LSA), and sends the LSA to other layer3 switches through link-state update (LSU) packets. Thus, each layer3 switches receives LSAs from other layer3 switches, and all LSAs combined to the link-state database.
2. Since a LSA is the description of the network topology structure around a layer3 switch, the LS database is the description of the network topology structure of the whole network. The layer3 switches can easily create a weighted vector map according to the LS database. Obviously, all layer3 switches in the same autonomous system will have the same network topology map.
3. Each layer3 switch uses the shortest path first (SPF) algorithm to calculate a tree of shortest path rooted by itself. The tree provides the route to all the nodes in the autonomous system, leaf nodes consist of the exterior route information. The exterior route can be marked by the layer3 switch broadcast it, so that additional information about the autonomous system can be recorded. As a result, the route table of each layer3 switch is different.

OSPFv3 protocol is developed by the IETF, the OSPF v3 used now is fulfilled according to the content described in RFC2328 and RFC2740.

As a result of continuous development of IPv6 network, it has the network environment of nonsupport IPv6 sometimes, so it needs to do the IPv6 operation by tunnel. Therefore, our OSPFv3 supports configuration on configure tunnel, and passes through nonsupport IPv6 network by unicast packet of IPv4 encapsulation.

---

## 39.2 OSPFv3 Configuration Task List

OSPFv3 Configuration Task List:

1. Enable OSPFv3 (required)
  - (1) Enable/disable OSPFv3(required)
  - (2) Configure the router-id number of the layer3 switch running OSPFv3 (optional)
  - (3) Configure the network scope for running OSPFv3 (optional)
  - (4) Enable OSPFv3 on the interface (required)
2. Configure OSPFv3 auxiliary parameters (optional)
  - (1) Configure OSPFv3 packet sending mechanism parameters
    - 1) Set the OSPFv3 interface to receive only
    - 2) Configure the cost for sending packets from the interface
    - 3) Configure OSPFv3 packet sending timer parameter (timer of broadcast interface sending HELLO packet to poll, timer of neighboring layer3 switch invalid timeout, timer of LSA transmission delay and timer of LSA retransmission.
  - (2) Configure OSPFv3 route introduction parameters
    - 1) Configure default parameters (default type, default tag value, default cost)
    - 2) Configure the routes of the other protocols to introduce to OSPFv3
  - (3) Configure OSPFv3 importing the routes of other OSPFv3 processes
    - 1) Enable the function of OSPFv3 importing the routes of other OSPFv3 processes
    - 2) Display relative information
    - 3) Debug
  - (4) Configure other OSPFv3 protocol parameters
    - 1) Configure OSPFv3 routing protocol priority
    - 2) Configure cost for OSPFv3 STUB area and default route
    - 3) Configure OSPFv3 virtual link
    - 4) Configure the priority of the interface when electing designated layer3 switch
3. Close OSPFv3 Protocol

### 1. Enable OSPFv3 Protocol

It is very simple to run the basic configurations of OSPFv3 routing protocol on the Layer 3 switch of SGS-6341 Series switch, normally only enabling OSPFv3, implement OSPFv3 interface, the default value is defined to OSPFv3 protocol parameters. Refer to 2. Configure OSPF auxiliary parameters, if the OSPFv3 protocol parameters need to be modified.

Commands	Explanation
Global Mode	
<b>[no] router IPv6 ospf &lt;tag&gt;</b>	The command initializes OSPFv3 routing process and enter OSPFv3 mode to configure OSPFv3 routing process. The <b>[no] router IPv6 ospf &lt;tag&gt;</b> command stops relative process. (required)
OSPFv3 Protocol Configure Mode	
<b>router-id &lt;router_id&gt;</b> <b>no router-id</b>	Configure router for OSPFv3 process. The <b>no router-id</b> command returns ID to 0.0.0.0 .(required)
<b>[no] passive-interface&lt;ifname&gt;</b>	Configure an interface receiving without sending. The <b>[no] passive-interface&lt;ifname&gt;</b> command cancels configuration.
Interface Configuration Mode	
<b>[no] IPv6 router ospf {area &lt;area-id&gt;</b> <b>[instance-id &lt;instance-id&gt;   tag &lt;tag&gt;</b> <b>[instance-id &lt;instance-id&gt;]]   tag &lt;tag&gt;</b> <b>area &lt;area-id&gt; [instance-id</b> <b>&lt;instance-id&gt;]}</b>	Implement OSPFv3 routing on the interface. The <b>[no] IPv6 router ospf {area &lt;area-id&gt;</b> <b>[instance-id &lt;instance-id&gt;   tag &lt;tag&gt;</b> <b>[instance-id &lt;instance-id&gt;]]   tag &lt;tag&gt;</b> <b>area &lt;area-id&gt; [instance-id</b> <b>&lt;instance-id&gt;]}</b> command cancels configuration.

## 2. Configure OSPFv3 parameters

### (1) Configure OSPFv3 packet sending mechanism parameters

- 1) Set the OSPF interface to receive only
- 2) Configure the cost for sending packets from the interface

Commands	Explanation
Interface Configuration Mode	
<b>IPv6 ospf cost &lt;cost&gt; [instance-id</b> <b>&lt;id&gt;]</b> <b>no IPv6 ospf cost [instance-id &lt;id&gt;]</b>	Appoint interface to implement required cost of OSPFv3 protocol. The <b>no IPv6 OSPF cost [instance-id &lt;id&gt;]</b> restores the default setting.

3) Configure OSPFv3 packet sending timer parameter (timer of broadcast interface sending HELLO packet to poll, timer of neighboring layer3 switch invalid timeout, timer of LSA transmission delay and timer of LSA retransmission).

Commands	Explanation
Interface Configuration Mode	
IPv6 ospf hello-interval <time> [instance-id <id> no IPv6 ospf hello-interval [instance-id <id>	Sets interval for sending HELLO packets; the “no IPv6 ospf hello-interval [instance-id <id>]” command restores the default setting.
IPv6 ospf dead-interval <time> [instance-id <id> no IPv6 ospf dead-interval [instance-id <id>	Sets the interval before regarding a neighbor layer3 switch invalid; the “no IPv6 ospf dead-interval [instance-id <id>]” command restores the default setting.
IPv6 ospf transit-delay <time> [instance-id <id> no IPv6 ospf transit-delay [instance-id <id>	Sets the delay time before sending link-state broadcast; the “no IPv6 ospf transit-delay [instance-id <id>]” command restores the default setting.
IPv6 ospf retransmit <time> [instance-id <id> no IPv6 ospf retransmit [instance-id <id>	.Sets the interval for retransmission of link-state advertisement among neighbor layer3 switches; the “no IPv6 ospf retransmit [instance-id <id>]” command restores the default setting.

## (2) Configure OSPFv3 route introduction parameters

Configure OSPFv3 route introduction parameters

Commands	Explanation
OSPF Protocol Mode	
[no]redistribute {kernel  connected  static  rip  isis  bgp} [metric<value>] [metric-type {1 2}][route-map<word>	Introduces other protocol discovery routing and static routing regarded as external routing message. The [no] redistribute {kernel  connected  static  rip  isis  bgp} [metric<value>] [metric-type {1 2}][route-map<word> command cancels imported external routing message.

### (3) Configure OSPFv3 importing the routes of other OSPFv3 processes

- 1) Enable the function of OSPFv3 importing the routes of other OSPFv3 processes

Command	Explanation
Router IPv6 OSPF Mode	
<b>redistribute ospf [&lt;process-id&gt;] [metric&lt;value&gt;] [metric-type {1 2}][route-map&lt;word&gt;] no redistribute ospf [&lt;process-id&gt;] [metric&lt;value&gt;] [metric-type {1 2}][route-map&lt;word&gt;]</b>	Enable or disable the function of OSPFv3 importing the routes of other OSPFv3 processes.

- 2) Display relative information

Command	Explanation
Admin Mode or Configure Mode	
<b>show ipv6 ospf [&lt;process-id&gt; redistribute</b>	Display the configuration information of the OSPFv3 process importing other outside routes.

- 3) Debug

Command	Explanation
Admin Mode	
<b>debug ipv6 ospf redistribute message send no debug ipv6 ospf redistribute message send debug ipv6 ospf redistribute route receive no debug ipv6 ospf redistribute route receive</b>	Enable or disable debugging of sending command from OSPFv3 process redistributed to other OSPFv3 process routing. Enable or disable debugging of received routing message from NSM for OSPFv3 process.



**(4) Configure Other Parameters of OSPFv3 Protocol**

- 1) Configure OSPFv3 STUB Area & Default Routing Cost
- 2) Configure OSPFv3 Virtual Link

Commands	Explanation
OSPFv3 Protocol Configuration Mode	
<b>timers spf &lt;spf-delay&gt; &lt;spf-holdtime&gt;</b> <b>no timers spf</b>	Configure OSPFv3 SPF timer. The <b>no timers spf</b> command recovers default value.
<b>area &lt;id&gt; stub [no-summary]</b> <b>no area &lt;id&gt; stub [no-summary]</b>  <b>area &lt;id&gt; default-cost &lt;cost&gt;</b> <b>no area &lt;id&gt; default-cost</b>  <b>area &lt;id&gt; virtual-link A.B.C.D [instance-id &lt;instance-id&gt; INTERVAL]</b> <b>no area &lt;id&gt; virtual-link A.B.C.D [INTERVAL]</b>	Configure parameters in OSPFv3 area (STUB area, Virtual link). The no command restores default value.

- 3) Configure the priority of the interface when electing designated layer3 switch (DR).

Commands	Explanation
Interface Configuration Mode	
<b>IPv6 ospf priority &lt;priority&gt;</b> <b>[instance-id &lt;id&gt;]</b> <b>no IPv6 ospf priority [instance-id &lt;id&gt;]</b>	Sets the priority of the interface in “designated layer3 switch” election; the “ <b>no IPv6 ospf priority [instance-id &lt;id&gt;]</b> ” command restores the default setting.

**3. Disable OSPFv3 Protocol**

Commands	Explanation
Global Mode	
<b>no router IPv6 ospf ospf [&lt;tag&gt;]</b>	Disable OSPFv3 Routing Protocol.

### 39.3 OSPFv3 Examples

**Examples 1:** OSPF autonomous system.

This scenario takes an OSPF autonomous system consists of five switch for example.

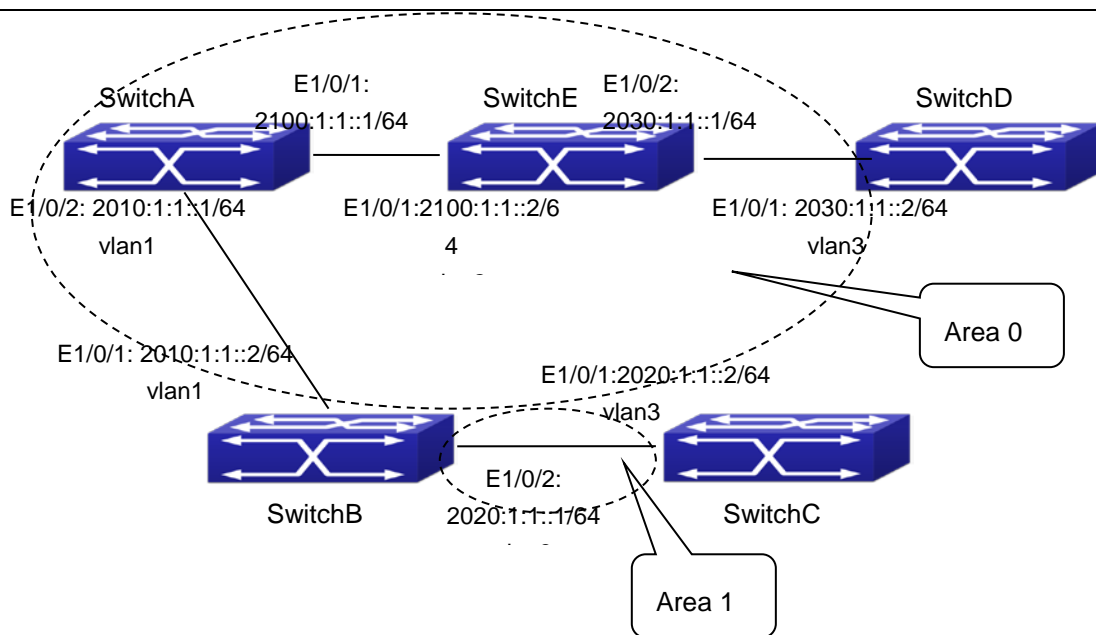

**Figure 39-1** Network topology of OSPF autonomous system

The configuration for layer3 SwitchA and SwitchE is shown below:

**Layer3 SwitchA:**

Enable OSPFv3 protocol, configure router ID

```
SwitchA(config)#router IPv6 ospf
SwitchA (config-router)#router-id 192.168.2.1
```

Configure interface vlan1 IPv6 address and affiliated OSPFv3 area

```
SwitchA#config
SwitchA(config)# interface vlan 1
SwitchA(config-if-vlan1)# IPv6 address 2010:1:1::1/64
SwitchA(config-if-vlan1)# IPv6 router ospf area 0
SwitchA(config-if-vlan1)#exit
```

Configure interface vlan2 IP address and affiliated OSPFv3 area

```
SwitchA(config)# interface vlan 2
SwitchA(config-if-vlan2)# IPv6 address 2100:1:1::1/64
SwitchA(config-if-vlan2)# IPv6 router ospf area 0
SwitchA (config-if-vlan2)#exit
SwitchA(config)#exit
SwitchA#
```

**Layer 3 SwitchB:**

Enable OSPFv3 protocol, configure router ID

```
SwitchB(config)#router IPv6 ospf
SwitchB (config-router)#router-id 192.168.2.2
```

---

Configure interface vlan1 address, VLAN2 IPv6 address and affiliated OSPFv3 area

```
SwitchB#config
SwitchB(config)# interface vlan 1
SwitchB(config-if-vlan1)# IPv6 address 2010:1:1::2/64
SwitchB(config-if-vlan1)# IPv6 router ospf area 0
SwitchB(config-if-vlan1)#exit
SwitchB(config)# interface vlan 3
SwitchB(config-if-vlan3)# IPv6 address 2020:1:1::1/64
SwitchB(config-if-vlan3)# IPv6 router ospf area 1
SwitchB(config-if-vlan3)#exit
SwitchB(config)#exit
SwitchB#
```

### Layer 3 SwitchC:

Enable OSPFv3 protocol, configure router ID

```
SwitchC(config)#router IPv6 ospf
SwitchC(config-router)#router-id 192.168.2.3
```

Configure interface vlan3 IPv6 address and affiliated OSPFv3 area

```
SwitchC#config
SwitchC(config)# interface vlan 3
SwitchC(config-if-vlan3)# IPv6 address 2020:1:1::2/64
SwitchC(config-if-vlan3)# IPv6 router ospf area 1
SwitchC(config-if-vlan3)#exit
SwitchC(config)#exit
SwitchC#
```

### Layer 3 SwitchD:

Enable OSPFv3 protocol, configure router ID

```
SwitchD(config)#router IPv6 ospf
SwitchD(config-router)#router-id 192.168.2.4
```

Configure interface vlan3 IPv6 address and affiliated OSPFv3 area

```
SwitchD#config
SwitchD(config)# interface vlan 3
SwitchD(config-if-vlan3)# IPv6 address 2030:1:1::2/64
SwitchD(config-if-vlan3)# IPv6 router ospf area 0
SwitchD(config-if-vlan3)#exit
SwitchD(config)#exit
SwitchD#
```

---

### Layer 3 SwitchE:

Startup OSPFv3 protocol, configure router ID

```
SwitchE(config)#router IPv6 ospf
SwitchE(config-router)#router-id 192.168.2.5
```

Configure interface IPv6 address and affiliated OSPFv3 area

```
SwitchE#config
SwitchE(config)# interface vlan 2
SwitchE(config-if-vlan2)# IPv6 address 2100:1:1::2/64
SwitchE(config-if-vlan2)# IPv6 router ospf area 0
SwitchE(config-if-vlan2)#exit
```

Configure interface VLAN3 IPv6 address and affiliated area

```
SwitchE(config)# interface vlan 3
SwitchE(config-if-vlan3)# IPv6 address 2030:1:1::1/64
SwitchE(config-if-vlan3)# IPv6 router ospf area 0
SwitchE(config-if-vlan3)#exit
SwitchE(config)#exit
SwitchE#
```

## 39.4 OSPFv3 Troubleshooting

In the process of configuring and implementing OSPFv3, physical connection, configuration false probably leads to OSPFv3 protocol doesn't work. Therefore, the customers should give their attention to it:

- First of all, to ensure correct physical connection;
- Secondly, to ensure interface and link protocol are UP (execute **show interface** instruction);
- And configure IPv6 address of the different net segment on every interface.
- To startup OSPFv3 protocol (execute **router IPv6 OSPF** instruction), and configure affiliated OSPFv3 area on relative interface.
- And then, consider OSPFv3 protocol characteristic —— OSPFv3 backbone area (area 0) must be continuous. If it doesn't ensure that virtual link is implemented continuously, all of not area 0 only can be connected by area 0 and other not area 0, not directly connected by not area 0; The border Layer 3 switch is a part of this Layer 3 switch interface belongs to area 0, and another part of interface belongs to not area 0; for multi-access net etc like broadcast, Layer 3 switch DR needs vote and appoint; for each OSPFv3 process must not configure router ID of 0.0.0.0 address.

---

# Chapter 40 BGP

## 40.1 Introduction to BGP

BGP stands for a Border Gateway Protocol. It's a dynamic routing protocol inter-autonomous system. Its basic function is automatically exchanging routing information without loops. By exchanging routing reachable information with autonomous number of AS sequence attributes, BGP could create autonomous topological map to eliminate routing loop and implement policies configured by users. Generally, the switches in an AS may use several IGPs (Interior Gateway Protocol) in order to exchange routing information in the AS, such as RIP and OSPF which are IGPs; and exchange information among ASes with EGP (Exterior Gateway Protocol). For example, BGP is one kind of EGP. The AS is usually established on a single administrative department. BGP is often used on the switches among ISPs or the departments of Multi-national Corporation. BGP has been used since 1989, its earliest three versions are RFC1105 (BGP-1) 、RFC1163 (BGP-2) and RFC1267 (BGP-3) .Currently, the most popular one is RFC1771 (BGP-4) . The switch supports BGP-4.

### 1 · Characteristics of BGP-4

BGP-4 is suitable for the distributed structure and supports Classless InterDomain Routing (CIDR). BGP-4 is becoming the virtual exterior routing protocol standard used for the global Internet. The features of BGP-4 are as follows.

- BGP is an exterior routing protocol, unlike interior routing protocol, such as OSPF and RIP, BGP can't discovery and calculate routes, but it can control the transmission of routes and select the best route.
- By carrying AS routing information in the updating route, the problem of Routing Loops can be resolved
- BGP uses TCP on port 179 as its transport protocol, this could enhance the reliability of the protocol.
- BGP-4 supports CIDR (Classless InterDomain Routing), which is an important improvement to BGP-3. CIDR has a brand new way to look on IP address; it doesn't distinguish class A , Class B and class C network. For instance, an illegal class C address 192.213.0.0 255.255.0.0 can be represented as 192.213.0.0/16 by CIDR which is a legal super network. /16 represents that the network number is formed by 16 bits from the beginning left of the address. The introduction of CIDR abbreviates the route aggregation. The route aggregation is the process of combining several different routes. So notifying several routes can be changed to notify only one route which decreases the route table.
- When updating route, BGP send only incremental route. The bandwidth occupied by BGP transmission is reduced greatly and it is suitable for the mass routing information transmitted on the internet
- For political and economical reasons, each AS expects to filter and control the route, BGP-4 provides abundant route policies which make BGP-4 more extendable to encourage the internet development.

---

## 2 · The Overview of BGP-4 operation

Unlike RIP and OSPF protocols, BGP protocol is connection oriented. BGP switches must establish connection to exchange routing information. The operation of BGP protocol is driven by messages and the messages can be divided into four kinds:

Open message----It's the first message which is sent after a TCP connection is established. It is used to create BGP connecting relation among BGP peers. Some parameters in Open Message are used to negotiate if a connection could be established among BGP peers.

Keepalive Message ----- it's the message to check connection availability. It's usually sent periodically to keep BGP connection. If this message or Update message is not received within holdtime time, BGP connection is closed.

Update Message----- it's the most important message in the BGP system. It's used to exchange routing information among peers. The switches exchange not only updated routing information, but also unavailable or canceled routing information. It consists of three parts: unreachable route, NLRI(Network Layer Reachability Information) and Path Attributes.

Notification Message-----it's the mistake notification message. When a BGP speaker receives this message, it shutdowns the BGP connections with its neighbors

BGP-4 is connection oriented. BGP acts as higher protocol and runs on the particular equipments. When detecting a neighbor, a TCP session is established and maintained. Then the exchanging and synchronization of the route table will be carried out. By sending the whole BGP route table the routing information is exchanged only when the system initiates. After that, the routing information is exchanged only when the updated routing information is available. Only incremental update message is exchanged. BGP-4 maintains links and sessions periodically through keep alive message. That is sending and receiving keep alive message periodically to check if the connections are normal.

The switches that participate the BGP session are called BGP speaker. It continuously receives or generates new routing information and advertises it to other BGP speakers. When a BGP speaker receives a new routing notification from other AS, if this route is better than the presently known route or there is no acceptable route, it sends this route to all the other BGP speakers of the AS. A BGP speaker calls other speakers that exchange route information with it as neighbors or peers. Several relevant neighbors can constitute a peer group. BGP operates on the switches in the following two manners:

- IBGP : Internal BGP
- EBGP : External BGP

When BGP runs in the same AS, it's called IBGP. When in the different AS, it's called EBGP. Generally, the outer neighbors are connected physically and the inner neighbors can be in any place of the AS. The difference is finally shown in the dealing manner of BGP to routing information. The equipments may check the AS numbers of the Open Message from neighbors to decide treating the neighbor switches as the exterior neighbor or as the interior neighbor.

---

IBGP are used in the AS. It sends message to all the BGP neighbors in the AS. IBGP exchanges AS routing information in a big organization. Attention, the switches in the AS needn't be connected physically. Only if the switches are in the same AS, they can be neighbors each other. Because BGP can't detect route, the route tables of other inner route protocols (such as static route, direct route, OSPF and RIP) need contain neighbor IP addresses and these routes are used to exchange information among BGPs. In order to avoid routing loops, when a BGP speaker receives a route notification from inner neighbor, it would not notify this route to other inner neighbors.

EBGP is used among the AS, and it transmits routing information to the BGP neighbors of outer ASes. EBGP need physical connection and share the same medium. Because EBGP need physical connection, the boundary equipments between two AS are usually running EBGP. When a BGP speaker receives routing information from outer neighbors, it notifies these routes to other inner neighbors.

### **3 · Route attribute**

BGP-4 can share and query inner IP route table through relevant mechanisms, but it has its own route table. In the BGP route table, each route has a network number, AS listing information (also called AS path) that it passed and some routing attributes (such as origin). The routing attribute that BGP-4 used is very complex, this attribute can be used as metrics to select path.

### **4 · Route-selecting policy of BGP**

When receiving BGP notification about a same route from several neighbors, selecting the best route need to be take into account after routing filtering. This process is called BGP route selecting process. BGP route selecting process will start only when the following conditions are fulfilled:

- The switch's route must be next hop reachable. That is in the route table there is the route that can reach the next hop.
- BGP must be synchronized with IGP (unless asynchronism is configured; only restricted to IBGP)

BGP route selecting process is based on the BGP attribute. When there are several routes that indicate the same destination, BGP need select the best route to the destination. The decision-making process is as the following:

- 1 · Select the route with the most weight first;
2. If the weights are the same, select the route with the most local preference;
3. If the local preferences are the same, select the route generated by local switch.
4. If the local preferences are the same and there is no route generated by local switch, select the route with the shortest AS path;
5. If the AS paths are the same, select the route with the lowest "origin" type ( IGP<EGP<INCOMPLETE );
6. If the "origin" types are the same, select the route with the lowest MED attribute. Unless activating command "bgp always-compare-med", this comparison is only available among the routes from the same neighbor AS.
7. If the MED attributes are the same, EBGP is preferable to outer confederation and outer confederation is preferable to IBGP.
8. If it's still the same by now, BGP router ID ( router ID ) is used to break the balance. The best route is the one from the least router ID.

- 
9. If it's still the same by now, BGP router ID (router ID) is used to break the balance. The best route is the one from the least router ID.

## 40.2 BGP Configuration Task List

The BGP configuration tasks include basic and advanced tasks. Basic BGP configuration tasks include the following:

- 1 · Enable BGP Routing (required)
- 2 · Configure BGP Neighbors (required)
- 3 · Administrate the change of routing policy
- 4 · Configure BGP Weights
- 5 · Configure BGP Route Filtering policy basing on Neighbors
- 6 · Configure Next-Hop of BGP
- 7 · Configure Multi-Hop of EGBP
- 8 · Configure BGP Session Identifier
- 9 · Configure BGP Version

Advanced BGP configuration tasks include the following:

- 1 · Use Route Maps to Modify Route
- 2 · Configure Route Aggregation
- 3 · Configure BGP Community Filtering
- 4 · Configure BGP Confederation
- 5 · Configure a Route Reflector
- 6 · Configure Peer Groups
- 7 · Configure Neighbors and Peer Groups' Parameters
- 8 · Adjust BGP Timers
- 9 · Adjust BGP Announcement Interval
- 10 · Configure the default Local Priority
- 11 · Allow to Transfer Default Route
- 12 · Configure BGP's MED Value
- 13 · Configure BGP Routing Redistribution
- 14 · Configure BGP Route Dampening
- 15 · Configure BGP capability Negotiation
- 16 · Configure Routing Server
- 17 · Configure Path-Selected Rule
- 18 · Configure redistribution of OSPF routing to BGP
  - (1) Enable redistribution of OSPF routing to BGP
  - (2) Display and debug the information about configuration of redistribution of OSPF routing to BGP



## 1. Enable BGP Routing

Command	Explanation
Global mode	
<b>router bgp &lt;as-id&gt;</b> <b>no router bgp &lt;as-id&gt;</b>	Enable BGP, the “no router bgp <as-id>”command disenable BGP process.
Router configuration mode	
<b>bgp asnotation asdot</b> <b>no bgp asnotation asdot</b>	Show AS number and match the regular expression with ASDOT method. The no command cancels this method.
<b>network &lt;ip-address/M&gt;</b> <b>no network &lt;ip-address/M&gt;</b>	Set the network that BGP will announce, the no network <ip-address/M> command cancels the network that will be announced.
<b>address-family ipv4 {unicast multicast vrf &lt;vrf-nam&gt;}</b> <b>no address-family ipv4 {unicast multicast vrf &lt;vrf-nam&gt;}</b>	Create IPv4 for BGP protocol and enter BGP-VPN view. Any IPv4 is not created by default.

## 2. Configure BGP Neighbors

Command	Explanation
Router configuration mode	
<b>neighbor {&lt;ip-address&gt; &lt;TAG&gt;}</b> <b>remote-as &lt;as-id&gt;</b> <b>no neighbor {&lt;ip-address&gt; &lt;TAG&gt;}</b> <b>[remote-as &lt;as-id&gt;]</b>	Specify a BGP neighbor, the <b>no neighbor {&lt;ip-address&gt; &lt;TAG&gt; [remote-as &lt;as-id&gt;]</b> command deletes the neighbor.

## 3. Administrate the change of routing policy

## (1) Configure hard reconfiguration.

Command	Explanation
Admin Mode	
<b>clear ip bgp {&lt;*&gt; &lt;as-id&gt; external peer-group &lt;NAME&gt; &lt;ip-address&gt;}</b>	Configure hard reconfiguration.

## (2) Configure outbound soft reconfiguration.

Command	Explanation
Admin Mode	
<b>clear ip bgp {&lt;*&gt; &lt;as-id&gt; external peer-group &lt;NAME&gt; &lt;ip-address&gt;} soft out</b>	Configure outbound soft reconfiguration.

(3) Configure inbound soft reconfiguration.

Command	Explanation
BGP configuration mode	
<b>neighbor { &lt;ip-address&gt;   &lt;TAG&gt; } soft-reconfiguration inbound no neighbor { &lt;ip-address&gt;   &lt;TAG&gt; } soft-reconfiguration inbound</b>	This command can store routing information from neighbors and peers; the <b>no neighbor { &lt;ip-address&gt;   &lt;TAG&gt; } soft-reconfiguration inbound</b> command cancels the storage of routing information.
Admin Mode	
<b>clear ip bgp {&lt;*&gt;/&lt;as-id&gt;  external peer-group &lt;NAME&gt; &lt;ip-address&gt;} soft in</b>	Configure BGP inbound soft reconfiguration.

4. Configure BGP Weights

Command	Explanation
BGP configuration mode	
<b>neighbor { &lt;ip-address&gt;   &lt;TAG&gt; } weight &lt;weight&gt; no neighbor { &lt;ip-address&gt;   &lt;TAG&gt; }</b>	Configure BGP neighbor weights; the <b>no neighbor { &lt;ip-address&gt;   &lt;TAG&gt; }</b> command recovers default weights.

5. Configure BGP Route Filtering policy based on neighbor

Command	Explanation
BGP configuration mode	
<b>neighbor {&lt;ip-address&gt;/&lt;TAG&gt;} distribute-list {&lt;1-199&gt;/&lt;1300-2699&gt;/&lt;WORD&gt;} {in out} no neighbor {&lt;ip-address&gt;/&lt;TAG&gt;} distribute-list {&lt;1-199&gt;/&lt;1300-2699&gt;/&lt;WORD&gt;} {in out}</b>	Filter neighbor routing updating information. The <b>no neighbor {&lt;ip-address&gt; / &lt;TAG&gt;} distribute-list {&lt;1-199&gt;/&lt;1300-2699&gt;/ &lt;WORD&gt;} {in out}</b> command cancels routing filter.

6. Configure Next-Hop

1) Set Next-Hop as the switch's address

Command	Explanation
BGP configuration mode	
<b>neighbor { &lt;ip-address&gt; / &lt;TAG&gt; } next-hop-self no neighbor { &lt;ip-address&gt; / &lt;TAG&gt; } next-hop-self</b>	While sending route Next-Hop set Next-Hop as the switch's address; the <b>no neighbor { &lt;ip-address&gt; / &lt;TAG&gt; } next-hop-self</b> command cancels the setting.

2) Cancel default Next-Hop through route map

Command	Explanation
Route mapped configuration command	
<b>set ip next-hop &lt;ip-address&gt;</b> <b>no set ip next-hop</b>	Set the Next-Hop attribute of outbound route. The <b>no set ip next-hop</b> command cancels this setting.

7. Configure EGBP Multi-Hop

If the connections with outer neighbors are not direct, the following command can configure neighbor Multi-Hop.

Command	Explanation
BGP configuration mode	
<b>neighbor {&lt;ip-address&gt;/&lt;TAG&gt;} ebgp-multihop [ &lt;1-255&gt;]</b> <b>no neighbor {&lt;ip-address&gt;/&lt;TAG&gt;} ebgp-multihop [ &lt;1-255&gt;]</b>	Configure the allowance of EGBP connection with other networks that are not connected directly; the <b>no neighbor {&lt;ip-address&gt;/&lt;TAG&gt;} ebgp-multihop [ &lt;1-255&gt;]</b> command cancels the setting.

8. Configure BGP session identifier

Command	Explanation
BGP configuration mode	
<b>bgp router-id &lt;ip-address&gt;</b> <b>no bgp router-id</b>	Configure the router-id value; the <b>no bgp router-id</b> command recovers the default value.

9. Configure the BGP Version

Command	Explanation
BGP configuration mode	
<b>neighbor {&lt;ip-address&gt; / &lt;TAG&gt;} version &lt;value&gt;</b> <b>no neighbor {&lt;ip-address&gt; / &lt;TAG&gt;} version</b>	Set the version used by BGP neighbors; the <b>no neighbor {&lt;ip-address&gt; / &lt;TAG&gt;} version</b> command recovers default setting. Presently only supporting version 4 <sup>th</sup> .

1 · Use Route Maps to Modify Route

Command	Explanation
BGP configuration mode	
<b>neighbor { &lt;ip-address&gt; / &lt;TAG&gt; } route-map &lt;map-name&gt; {in   out}</b> <b>no neighbor { &lt;ip-address&gt; / &lt;TAG&gt; } route-map &lt;map-name&gt; {in   out}</b>	Apply a route map to incoming or outgoing routes; the <b>no neighbor { &lt;ip-address&gt; / &lt;TAG&gt; } route-map &lt;map-name&gt; {in   out}</b> command cancels the settings of routing maps.

2 · Configure Route Aggregation

Command	Explanation
BGP configuration mode	
<b>aggregate-address &lt;ip-address/M&gt; [summary-only] [as-set]</b> <b>no aggregate-address &lt;ip-address/M&gt; [summary-only] [as-set]</b>	Create an aggregate entry in the BGP routing table; the <b>no aggregate-address &lt;ip-address/M&gt; [summary-only] [as-set]</b> command cancels the aggregate entry.

3 · Configure BGP Community Filtering

Command	Explanation
BGP configuration mode	
<b>neighbor {&lt;ip-address&gt; / &lt;TAG&gt;} send-community</b> <b>no neighbor {&lt;ip-address&gt; / &lt;TAG&gt;} send-community</b>	Allow the routing updates with community attributes sending to BGP neighbors; the <b>no neighbor {&lt;ip-address&gt; / &lt;TAG&gt;} send-community</b> command enables the route without community attributes.

#### 4 · Configure BGP Confederation

Command	Explanation
BGP configuration mode	
<b>bgp confederation identifier &lt;as-id&gt;</b> <b>no bgp confederation identifier &lt;as-id&gt;</b>	Configure a BGP AS confederation identifier; the <b>no bgp confederation identifier &lt;as-id&gt;</b> command deletes the BGP AS confederation identifier.
<b>bgp confederation peers &lt;as-id&gt; [&lt;as-id&gt;..]</b> <b>no bgp confederation peers &lt;as-id&gt; [&lt;as-id&gt;..]</b>	Configure the AS affiliated to the AS confederation; the <b>no bgp confederation peers &lt;as-id&gt; [&lt;as-id&gt;..]</b> command deletes the AS from the AS confederation.

#### 5 · Configure a Route Reflector

- (1) The following commands can be used to configure route reflector and its clients.

Command	Explanation
BGP configuration mode	
<b>neighbor &lt;ip-address&gt; route-reflector-client</b> <b>no neighbor &lt;ip-address&gt; route-reflector-client</b>	Configure the current switch as route reflector and specify a client. the <b>no neighbor &lt;ip-address&gt; route-reflector-client</b> commands format deletes a client.

- (2) If there are more than one route reflectors in the cluster, the following commands can configure cluster-id

Command	Explanation
BGP configuration mode	
<b>bgp cluster-id &lt;cluster-id&gt;</b> <b>no bgp cluster-id</b>	Configure cluster id; format “no” of the <b>no bgp cluster-id</b> command cancels the cluster id configuration.

- (3) If the route reflector from clients to clients is needed, the following commands can be used.

Command	Explanation
BGP configuration mode	
<b>bgp client-to-client reflection</b> <b>no bgp client-to-client reflection</b>	Configure the allowance of the route reflector from clients to clients; the <b>no bgp client-to-client reflection</b> command forbids this allowance.

## 6 · Configure Peer Groups

- (1) Create peer groups

Command	Explanation
BGP configuration mode	
<b>neighbor &lt;TAG&gt; peer-group</b> <b>no neighbor &lt;TAG&gt; peer-group</b>	Create peer groups; the <b>no neighbor &lt;TAG&gt; peer-group</b> command deletes peer groups.

- (2) Add neighbors to peers groups

Command	Explanation
BGP configuration mode	
<b>neighbor &lt;ip-address&gt; peer-group &lt;TAG&gt;</b> <b>no neighbor &lt;ip-address&gt; peer-group &lt;TAG&gt;</b>	Make a neighbor a member of the peer group. The <b>no neighbor &lt;ip-address&gt; peer-group &lt;TAG&gt;</b> command cancels the specified member.

## 7 · Configure neighbors and peer Groups' parameters

Command	Explanation
BGP configuration mode	
<b>neighbor { &lt;ip-address&gt; / &lt;TAG&gt; } remote-as &lt;as-id&gt;</b> <b>no neighbor { &lt;ip-address&gt; / &lt;TAG&gt; } remote-as &lt;as-id&gt;</b>	Specify a BGP neighbor; the <b>no neighbor { &lt;ip-address&gt; / &lt;TAG&gt; } remote-as &lt;as-id&gt;</b> command deletes the neighbor.
<b>neighbor { &lt;ip-address&gt; / &lt;TAG&gt; } description &lt;.LINE&gt;</b> <b>no neighbor { &lt;ip-address&gt; / &lt;TAG&gt; } description</b>	Associate a description with a neighbor; the <b>no neighbor { &lt;ip-address&gt; / &lt;TAG&gt; } description</b> command deletes this description.
<b>neighbor { &lt;ip-address&gt; / &lt;TAG&gt; } default-originate [route-map &lt;NAME&gt;]</b>	Permit to send the default route 0.0.0.0; the <b>no neighbor</b>

<pre>no neighbor { &lt;ip-address&gt;   &lt;TAG&gt; } default-originate [route-map &lt;NAME&gt;]</pre>	<pre>{ &lt;ip-address&gt;   &lt;TAG&gt; } default-originate [route-map &lt;NAME&gt;] command cancels sending default route.</pre>
<pre>neighbor { &lt;ip-address&gt;   &lt;TAG&gt; } send-community no neighbor { &lt;ip-address&gt;   &lt;TAG&gt; } send-community</pre>	<p>Configure the community attributes sent to the neighbor.</p>
<pre>neighbor { &lt;ip-address&gt;   &lt;TAG&gt; } timers &lt;keep alive&gt; &lt;holdtime&gt; no neighbor { &lt;ip-address&gt;   &lt;TAG&gt; } timers</pre>	<p>Configure a particular neighbor's keep-alive and hold-time timer; the <b>no neighbor {&lt;ip-address&gt;   &lt;TAG&gt;} timers</b> command recovers the default value.</p>
<pre>neighbor { &lt;ip-address&gt;   &lt;TAG&gt;} advertisement-interval &lt;seconds&gt; no neighbor { &lt;ip-address&gt;   &lt;TAG&gt;} advertisement-interval</pre>	<p>Configure the min interval of sending BGP routing information; the <b>no neighbor {&lt;ip-address&gt;   &lt;TAG&gt;} advertisement-interval</b> command recovers the default value.</p>
<pre>neighbor { &lt;ip-address&gt;   &lt;TAG&gt;} ebgp-multihop [&lt;1-255&gt;] no neighbor { &lt;ip-address&gt;   &lt;TAG&gt;} ebgp-multihop</pre>	<p>Configure the allowance of EBGp connections with networks connected indirectly; the <b>no neighbor {&lt;ip-address&gt;   &lt;TAG&gt;} ebgp-multihop</b> command cancels this setting.</p>
<pre>neighbor { &lt;ip-address&gt;   &lt;TAG&gt; } weight &lt;weight&gt; no neighbor { &lt;ip-address&gt;   &lt;TAG&gt; } weight</pre>	<p>Configure BGP neighbor weights; the <b>no neighbor { &lt;ip-address&gt;   &lt;TAG&gt; } weight</b> command recovers the default weights.</p>
<pre>neighbor { &lt;ip-address&gt;   &lt;TAG&gt; } distribute-list { &lt;access-list-number&gt;   &lt;name&gt; } { in   out } no neighbor { &lt;ip-address&gt;   &lt;TAG&gt; } distribute-list { &lt;access-list-number&gt;   &lt;name&gt; } { in   out }</pre>	<p>Filter neighbor route update; the <b>no neighbor { &lt;ip-address&gt;   &lt;TAG&gt; } distribute-list { &lt;access-list-number&gt;   &lt;name&gt; } { in   out }</b> command cancels route filtering.</p>
<pre>neighbor { &lt;ip-address&gt;   &lt;TAG&gt; } route-reflector-client no neighbor { &lt;ip-address&gt;   &lt;TAG&gt; } route-reflector-client</pre>	<p>Configure the current switch as route reflector and specify a client; the <b>no neighbor { &lt;ip-address&gt;   &lt;TAG&gt; } route-reflector-client</b></p>

	command deletes a client.
<b>neighbor { &lt;ip-address&gt; / &lt;TAG&gt; } next-hop-self</b> <b>no neighbor { &lt;ip-address&gt; / &lt;TAG&gt; }</b> <b>next-hop-self</b>	When sending route, configure Next-Hop as its address; the <b>no neighbor { &lt;ip-address&gt; / &lt;TAG&gt; } next-hop-self</b> command cancels the setting.
<b>neighbor { &lt;ip-address&gt; / &lt;TAG&gt; } version &lt;value&gt;</b> <b>no neighbor { &lt;ip-address&gt; / &lt;TAG&gt; } version</b>	Specify the BGP version communicating with BGP neighbors; the <b>no neighbor { &lt;ip-address&gt; / &lt;TAG&gt; } version</b> command recovers default setting.
<b>neighbor { &lt;ip-address&gt; / &lt;TAG&gt; } route-map &lt;map-name&gt; {in   out}</b> <b>no neighbor { &lt;ip-address&gt; / &lt;TAG&gt; } route-map &lt;map-name&gt; {in   out}</b>	Apply a route map to incoming or outgoing routes; the <b>no neighbor { &lt;ip-address&gt; / &lt;TAG&gt; } route-map &lt;map-name&gt; {in   out}</b> command cancels the setting of route reflector.
<b>neighbor { &lt;ip-address&gt; / &lt;TAG&gt; } soft-reconfiguration inbound</b> <b>no neighbor { &lt;ip-address&gt; / &lt;TAG&gt; } soft-reconfiguration inbound</b>	Store the route information from neighbor or peers; the <b>no neighbor { &lt;ip-address&gt; / &lt;TAG&gt; } soft-reconfiguration inbound</b> command cancels the storage.
<b>neighbor { &lt;ip-address&gt; / &lt;TAG&gt; } shutdown</b> <b>no neighbor { &lt;ip-address&gt; / &lt;TAG&gt; } shutdown</b>	Shutdown BGP neighbor or peers; the <b>no neighbor { &lt;ip-address&gt; / &lt;TAG&gt; } shutdown</b> command activates the closed BGP neighbor or peers.

## 8 · Adjust BGP Timers

### (1) Configure the BGP timer of all the neighbors

Command	Explanation
BGP configuration mode	
<b>timers bgp &lt;keep alive&gt; &lt;holdtime&gt;</b> <b>no timers bgp</b>	Configure the BGP timers of all the neighbors; the no timer bgp command recovers the default value.



(2) Configure the timer value of a particular neighbor

Command	Explanation
BGP configuration mode	
<b>neighbor { &lt;ip-address&gt; / &lt;TAG&gt; } timers &lt;keep alive&gt; &lt;holdtime&gt;</b> <b>no neighbor { &lt;ip-address&gt; / &lt;TAG&gt; } timers</b>	Configure the keep alive and holdtime timer of a particular neighbor; the <b>no neighbor { &lt;ip-address&gt; / &lt;TAG&gt; } timers</b> command recovers the default value.

9 · Adjust BGP announcement Interval

Command	Explanation
BGP configuration mode	
<b>neighbor { &lt;ip-address&gt; / &lt;TAG&gt; } advertisement-interval &lt;seconds&gt;</b> <b>no neighbor { &lt;ip-address&gt; / &lt;TAG&gt; } advertisement-interval</b>	Configure the minimum interval among BGP routes update information; the <b>no neighbor { &lt;ip-address&gt; / &lt;TAG&gt; } advertisement-interval</b> command recovers the default setting.

10 · Configure the Local Preference Value

Command	Explanation
BGP configuration mode	
<b>bgp default local-preference &lt;value&gt;</b> <b>no bgp default local-preference</b>	Change default local preference; the <b>no bgp default local-preference</b> command recovers the default value.

11 · Enable sending default route

Command	Explanation
BGP configuration mode	
<b>neighbor { &lt;ip-address&gt; / &lt;TAG&gt; } default-originate</b> <b>no neighbor { &lt;ip-address&gt; / &lt;TAG&gt; } default-originate</b>	Permit sending default route 0.0.0.0; the <b>no neighbor { &lt;ip-address&gt; / &lt;TAG&gt; } default-originate</b> command cancels sending default route.

## 12 · Configure BGP's MED Value

### (1) Configure MED value

Command	Explanation
Route map configuration command	
<b>set metric &lt;metric-value&gt;</b> <b>no set metric</b>	Configure metric value; the <b>no set metric</b> command recovers the default value.

### (2) Apply route selection based on MED according to the path from different AS

Command	Explanation
BGP configuration mode	
<b>bgp always-compare-med</b> <b>no bgp always-compare-med</b>	Permit the MED comparison from different AS; the <b>no bgp always-compare-med</b> command forbids the comparison.

## 13 · Configure BGP routing redistribution

Command	Explanation
BGP configuration mode	
<b>redistribute { connected   static   rip   ospf } [metric &lt;metric&gt;] [route-map &lt;NAME&gt;]</b> <b>no redistribute { connected   static   rip   ospf }</b>	Redistribute IGP routes to BGP and may specify the redistributed metric and route reflector; the <b>no redistribute { connected   static   rip   ospf }</b> command cancels the redistribution.

## 14 · Configure Route Dampening

Command	Explanation
BGP configuration mode	
<b>bgp dampening [&lt;1-45&gt;] [&lt;1-20000&gt; &lt;1-20000&gt; &lt;1-255&gt;] [&lt;1-45&gt;]</b> <b>no bgp dampening</b>	Enable BGP route dampening and apply the specified parameters; the <b>no bgp dampening</b> command stops route dampening

## 15 · Configure BGP capability Negotiation

Command	Explanation
BGP configuration mode	
<b>neighbor {&lt;ip-address&gt;/&lt;TAG&gt;} capability {dynamic   route-refresh}</b> <b>no neighbor {&lt;ip-address&gt;/&lt;TAG&gt;} capability {dynamic   route-refresh}</b>	BGP provides capability negotiation regulation and carry out this capability match while establishing connection. The currently supported capabilities include

<b>neighbor {&lt;ip-address&gt;/&lt;TAG&gt;}  capability orf prefix-list  {&lt;both&gt;/&lt;send&gt;/&lt;receive&gt;}  no neighbor {&lt;ip-address&gt;/&lt;TAG&gt;}  capability orf prefix-list  {&lt;both&gt;/&lt;send&gt;/&lt;receive&gt;}  neighbor {&lt;ip-address&gt;/&lt;TAG&gt;}  dont-capability-negotiate  no neighbor {&lt;ip-address&gt;/&lt;TAG&gt;}  dont-capability-negotiate  neighbor {&lt;ip-address&gt;/&lt;TAG&gt;}  override-capability  no neighbor {&lt;ip-address&gt;/&lt;TAG&gt;}  override-capability  neighbor {&lt;ip-address&gt;/&lt;TAG&gt;}  strict-capability-match  no neighbor {&lt;ip-address&gt;/&lt;TAG&gt;}  strict-capability-match</b>	route update, dynamic capability, outgoing route filtering capability and the address family's capability of supporting the negotiation. Use these command to enable these capabilities, its format "no" close these capabilities .It can also be configured by commands to not do capability negotiation, do strict capability negotiation or not care about the negotiation results.
---	--

16 · Configure Routing Server

Command	Explanation
BGP configuration mode	
<b>neighbor {&lt;ip-address&gt;/&lt;TAG&gt;}  route-server-client  no neighbor {&lt;ip-address&gt;/&lt;TAG&gt;}  route-server-client</b>	Route server may configure BGP neighbors under EBGP environment to reduce the number of peers that every client has configured; format "no" of the command configures this router as route server and specify the clients it serves, the <b>no neighbor {&lt;ip-address&gt;/&lt;TAG&gt;} route-server-client</b> command can delete clients.

17 · Configure Path-selected rules

Command	Explanation
BGP configuration mode	
<b>bgp always-compare-med  no bgp always-compare-med  bgp bestpath as-path ignore  no bgp bestpath as-path ignore  bgp bestpath compare-confed-aspath</b>	BGP may change some path-select rules by configuration to change the best selection and compare MED under EBGP environment through these command, ignore the AS-PATH length, compare the

<b>no bgp bestpath compare-confed-aspath bgp bestpath compare-routerid no bgp bestpath compare-routerid bgp bestpath med {[confed] [missing-is-worst]} no bgp bestpath med {[confed] [missing-is-worst]}</b>	confederation as-path length, compare the route identifier and compare the confederation MED etc. Its format "no" recovers the default route path-selected rules.
--	---

## 18. Configure redistribution of OSPF routing to BGP

(1) Enable redistribution of OSPF routing to BGP

Command	Explanation
Router BGP Configuration Mode	
<b>redistribute ospf [&lt;process-id&gt; [route-map&lt;word&gt;] no redistribute ospf [&lt;process-id&gt;</b>	To enable or disable the redistribution of OSPF routing to BGP.

(2) Display and debug the information about configuration of redistribution of OSPF routing to BGP

Command	Explanation
Admin Mode and Configuration Mode	
<b>show ip bgp redistribute</b>	To enable or disable the redistribution of OSPF routing to BGP.
Admin Mode	
<b>debug bgp redistribute message send no debug bgp redistribute message send debug bgp redistribute route receive no debug bgp redistribute route receive</b>	To enable or disable debugging messages sent by BGP for redistributing OSPF routing. To enable or disable debugging messages received from NSM for redistributing OSPF routing.

## 40.3 Configuration Examples of BGP

### 40.3.1 Examples 1: configure BGP neighbor

SwitchB, SwitchC and SwitchD are in AS200, SwitchA is in AS100. SwitchA and SwitchB share the same network segment. SwitchB and SwitchD are not connected physically.

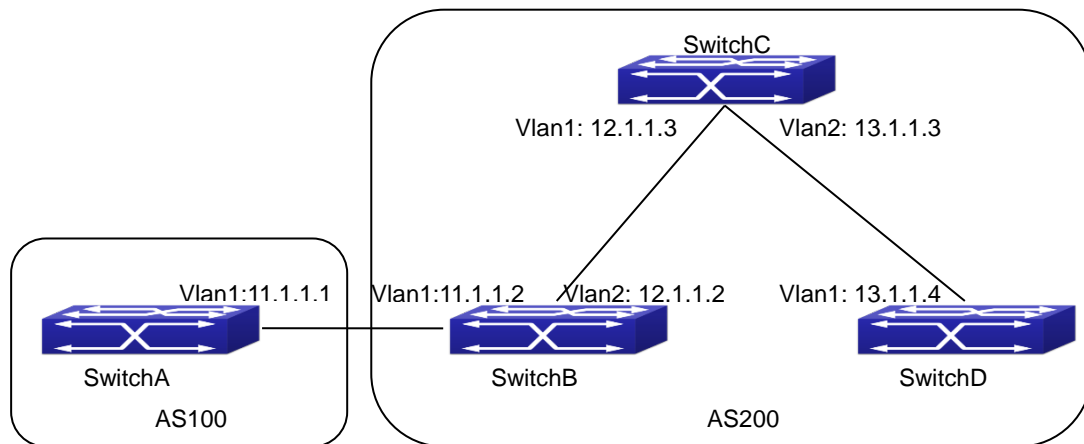

Figure 40-1 BGP Network Topological Map

The configurations of SwitchA are as following:

```
SwitchA(config)#router bgp 100
SwitchA(config-router-bgp)#neighbor 11.1.1.2 remote-as 200
SwitchA(config-router-bgp)#exit
```

The configurations of SwitchB are as following:

```
SwitchB(config)#router bgp 200
SwitchB(config-router-bgp)#network 11.0.0.0
SwitchB(config-router-bgp)#network 12.0.0.0
SwitchB(config-router-bgp)#network 13.0.0.0
SwitchB(config-router-bgp)#neighbor 11.1.1.1 remote-as 100
SwitchB(config-router-bgp)#neighbor 12.1.1.3 remote-as 200
SwitchB(config-router-bgp)#neighbor 13.1.1.4 remote-as 200
SwitchB(config-router-bgp)#exit
```

The configurations of SwitchC are as following:

```
SwitchC(config)#router bgp 200
SwitchC(config-router-bgp)#network 12.0.0.0
SwitchC(config-router-bgp)#network 13.0.0.0
SwitchC(config-router-bgp)#neighbor 12.1.1.2 remote-as 200
SwitchC(config-router-bgp)#neighbor 13.1.1.4 remote-as 200
SwitchC(config-router-bgp)#exit
```

---

The configurations of SwitchD are as following:

```
SwitchD(config)#router bgp 200
SwitchD(config-router-bgp)#network 13.0.0.0
SwitchD(config-router-bgp)#neighbor 12.1.1.2 remote-as 200
SwitchD(config-router-bgp)#neighbor 13.1.1.3 remote-as 200
SwitchD(config-router-bgp)#exit
```

Presently, the connection between SwitchB and SwitchA is EBGP, and other connections with SwitchC and SwitchD are IBGP. SwitchB and SwitchD may have BGP connection without physical connection. But there is a precondition that these two switches must have reachable route to each other. This route can be attained through static route or IGP.

### 40.3.2 Examples 2: configure BGP aggregation

In this sample, configure route aggregation. Firstly, enable command redistribute to redistribute static route to BGP route table:

```
SwitchB(config)#ip route 193.0.0.0/24 11.1.1
SwitchB(config)#router bgp 100
SwitchB(config-router-bgp)#redistribute static
```

When there is at least one route affiliated to the specified range, the following configuration will create an aggregation route in the BGP route table. The aggregation route will be regarded as the AS from itself. More detailed route information about 193.0.0.0 will be announced.

```
SwitchB(config)#router bgp 100
SwitchB(config-router-bgp)#aggregate 193.0.0.0/16
```

At the same time, the aggregation command above can be modified as following, then this switch only announce aggregation route 193.0.0.0 and forbid to announce more specified route to all the neighbors.

```
SwitchB(config-router-bgp)#aggregate 193.0.0.0/16 summary-only
```

### 40.3.3 Examples 3: configure BGP community attributes

In the following sample, "route map set-community" is used for the outgoing update to neighbor 16.1.1.6. By accessing to route in table 1 to configure special community value to "1111", other can be announced normally.

```

Switch(config)#router bgp 100
Switch(config-router-bgp)#neighbor 16.1.1.6 remote-as 200
Switch(config-router-bgp)#neighbor 16.1.1.6 route-map set-community out
Switch(config-router-bgp)#exit
Switch(config)#route-map set-community permit 10
Switch(config-route-map)#match address 1
Switch(config-route-map)#set community 1111
Switch(config-route-map)#exit
Switch(config)#route-map set-community permit 20
Switch(config-route-map)#match address 2
Switch(config-route-map)#exit
Switch(config)#access-list 1 permit 11.1.0.0 0.0.255.255
Switch(config)#access-list 2 permit 0.0.0.0 255.255.255.255
Switch(config)#exit
Switch#clear ip bgp 16.1.1.6 soft out

```

In the following sample, configure the MED local preference of the routes from neighbor 16.1.1.6 selectively according to the route community value. All the routes that match the community list will set MED as 2000, community list com1 permits the route with community value "100 200 300" or "900 901" to pass. This route may have other community attributes. All the routes that pass community list com2 will set the local preference as 500. But the route that can't pass both com1 and com2 will be rejected.

```

Switch(config)#router bgp 100
Switch(config-router-bgp)#neighbor 16.1.1.6 remote-as 200
Switch(config-router-bgp)#neighbor 16.1.1.6 route-map match-community in
Switch(config-router-bgp)#exit
Switch(config)#route-map match-community permit 10
Switch(config-route-map)#match community com1
Switch(config-route-map)#set metric 2000
Switch(config-route-map)#exit
Switch(config)#route-map match-community permit 20
Switch(config-route-map)#match community com2
Switch(config-route-map)#set local-preference 500
Switch(config-route-map)#exit
Switch(config)#ip community-list com1 permit 100 200 300
Switch(config)#ip community-list com1 permit 900 901
Switch(config)#ip community-list com2 permit 88
Switch(config)#ip community-list com2 permit 90
Switch(config)#exit
Switch#clear ip bgp 16.1.1.6 soft out

```

## 40.3.4 Examples 4: configure BGP confederation

The following is the configuration of an AS. As the picture illustrated, SwitchB and SwitchC establish IBGP connection. SwitchD is affiliated to AS 20. SwitchB and SwitchC establish EBGP of inner AS confederation. AS10 and AS20 form AS confederation with the AS number AS200; SwitchA belongs to AS100, SwitchB may create EBGP connection by AS200.

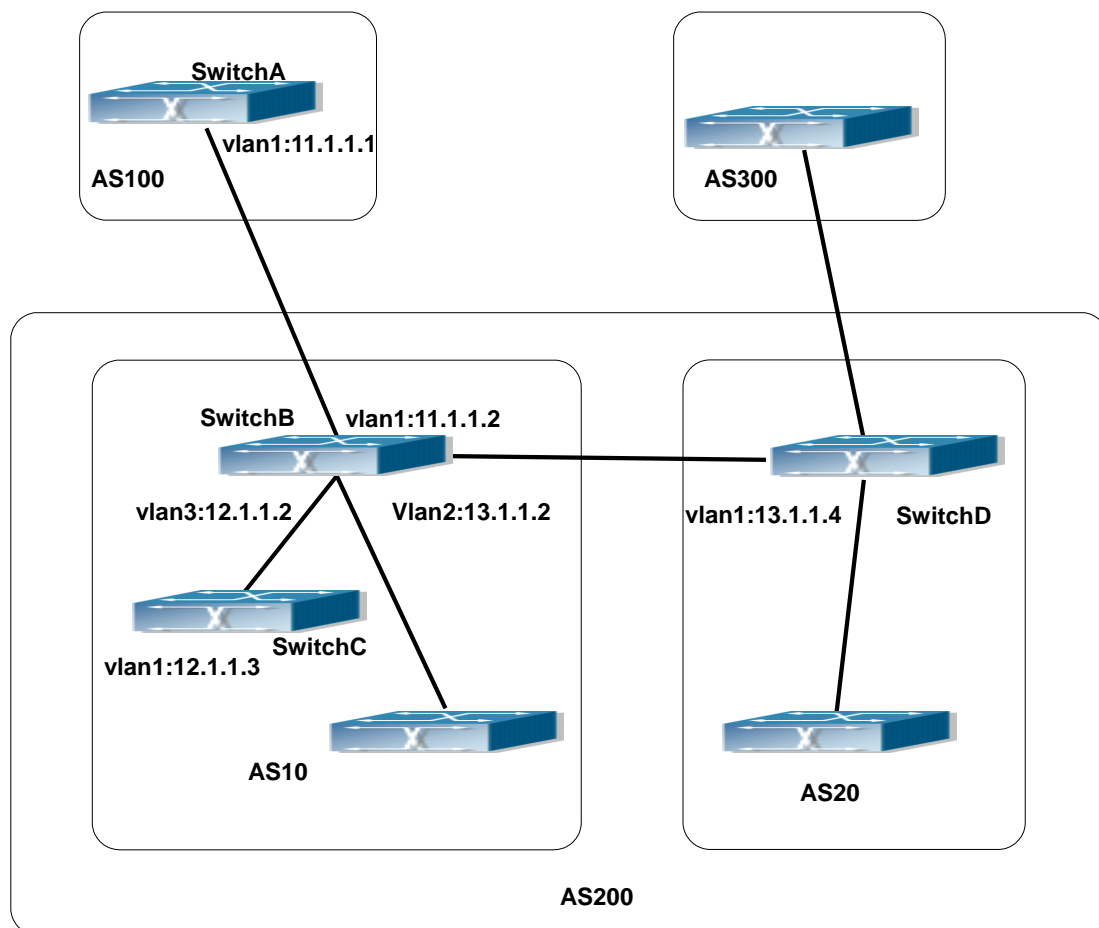

Figure 40-2 Confederation configuring topology

The configurations are as following:

### SwitchA:

```
SwitchA(config)#router bgp 100
SwitchA(config-router-bgp)#neighbor 11.1.1.2 remote-as 200
```

### SwitchB:

```
SwitchB(config)#router bgp 10
SwitchB(config-router-bgp)#bgp confederation identifier 200
SwitchB(config-router-bgp)#bgp confederation peers 20
SwitchB(config-router-bgp)#neighbor 12.1.1.3 remote-as 10
SwitchB(config-router-bgp)#neighbor 13.1.1.4 remote-as 20
```



```
SwitchB(config-router-bgp)#neighbor 11.1.1.1 remote-as 100
```

**SwitchC:**

```
SwitchC(config)#router bgp 10  
SwitchC(config-router-bgp)#bgp confederation identifier 200  
SwitchC(config-router-bgp)#bgp confederation peers 20  
SwitchC(config-router-bgp)#neighbor 12.1.1.2 remote-as 10
```

**SwitchD:**

```
SwitchD(config)#router bgp 20  
SwitchD(config-router-bgp)#bgp confederation identifier 200  
SwitchD(config-router-bgp)#bgp confederation peers 10  
SwitchD(config-router-bgp)#neighbor 13.1.1.2 remote-as 10
```

### 40.3.5 Examples 5: configure BGP route reflector

The following is the configuration of a route reflector. As the picture illustrated, SwitchA, SwitchB, SwitchC, SwitchD, SWE, SWF and SWG establish IBGP connection which is affiliated to AS100. SwitchC creates EBGP connection with AS200. SwitchA creates EBGP connection with AS300. SwitchC, SwitchD and SWG make route reflectors.

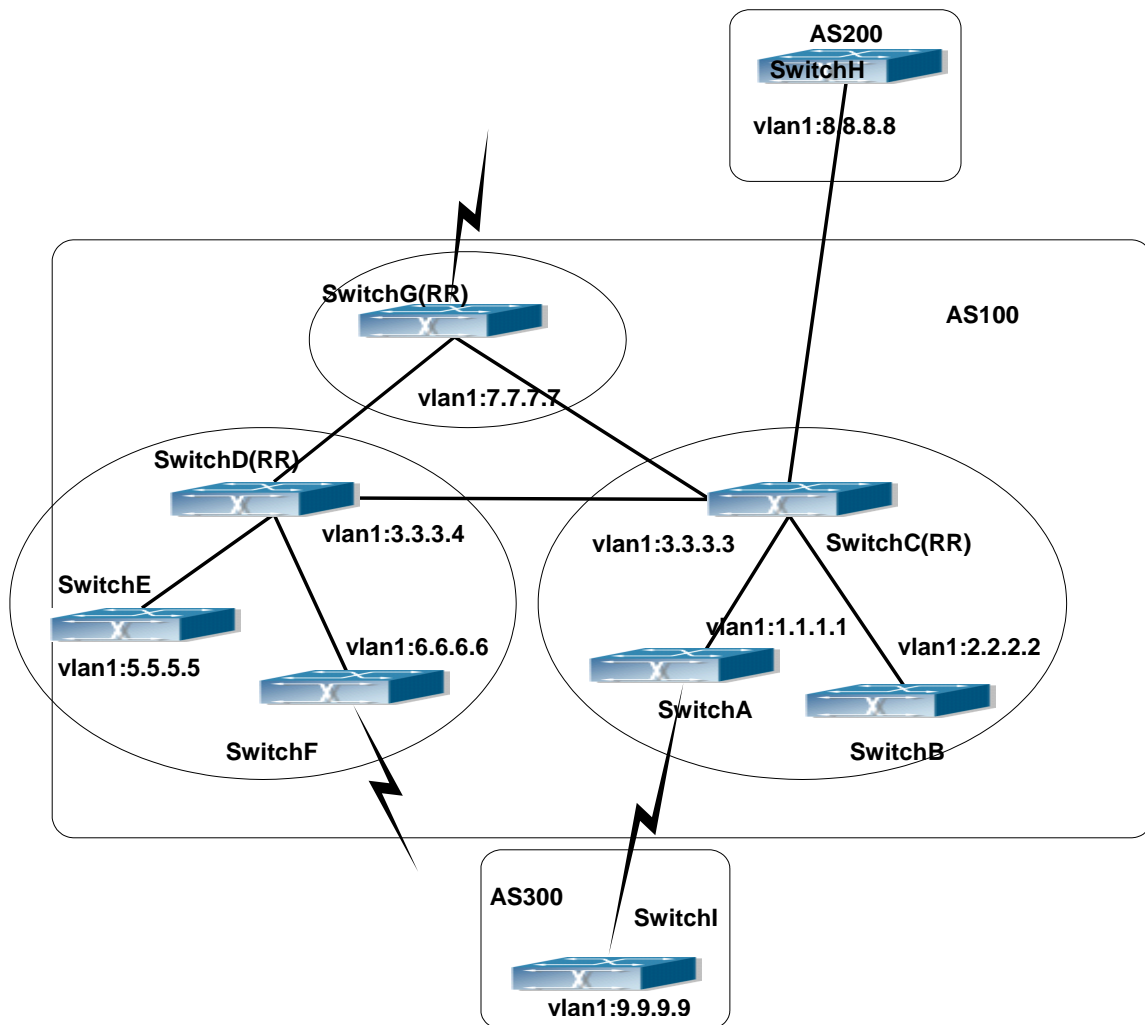

**Figure 40-3** the Topological Map of Route Reflector

The configurations are as following:

**The configurations of SwitchC:**

```
SwitchC(config)#router bgp 100
SwitchC(config-router-bgp)#neighbor 1.1.1.1 remote-as 100
SwitchC(config-router-bgp)#neighbor 1.1.1.1 route-reflector-client
SwitchC(config-router-bgp)#neighbor 2.2.2.2 remote-as 100
SwitchC(config-router-bgp)#neighbor 2.2.2.2 route-reflector-client
SwitchC(config-router-bgp)#neighbor 7.7.7.7 remote-as 100
SwitchC(config-router-bgp)#neighbor 3.3.3.4 remote-as 100
SwitchC(config-router-bgp)#neighbor 8.8.8.8 remote-as 200
```

**The configurations of SwitchD:**

```
SwitchD(config)#router bgp 100
SwitchD(config-router-bgp)#neighbor 5.5.5.5 remote-as 100
SwitchD(config-router-bgp)#neighbor 5.5.5.5 route-reflector-client
```

```

SwitchD(config-router-bgp)#neighbor 6.6.6.6 remote-as 100
SwitchD(config-router-bgp)#neighbor 6.6.6.6 route-reflector-client
SwitchD(config-router-bgp)#neighbor 3.3.3.3 remote-as 100
SwitchD(config-router-bgp)#neighbor 7.7.7.7 remote-as 100

```

**The configurations of SwitchA:**

```

SwitchA(config)#router bgp 100
SwitchA(config-router-bgp)#neighbor 1.1.1.2 remote-as 100
SwitchA(config-router-bgp)#neighbor 9.9.9.9 remote-as 300

```

The SwitchA at this time needn't to create IBGP connection with all the switches in the AS100 and could receive BGP route from other switches in the AS.

**40.3.6 Examples 6: configure MED of BGP**

The following is the configuration of a MED. As illustrated, SwitchA is affiliated to AS100, SwitchB is affiliated to AS400, SwitchC and SwitchD belong to AS300.

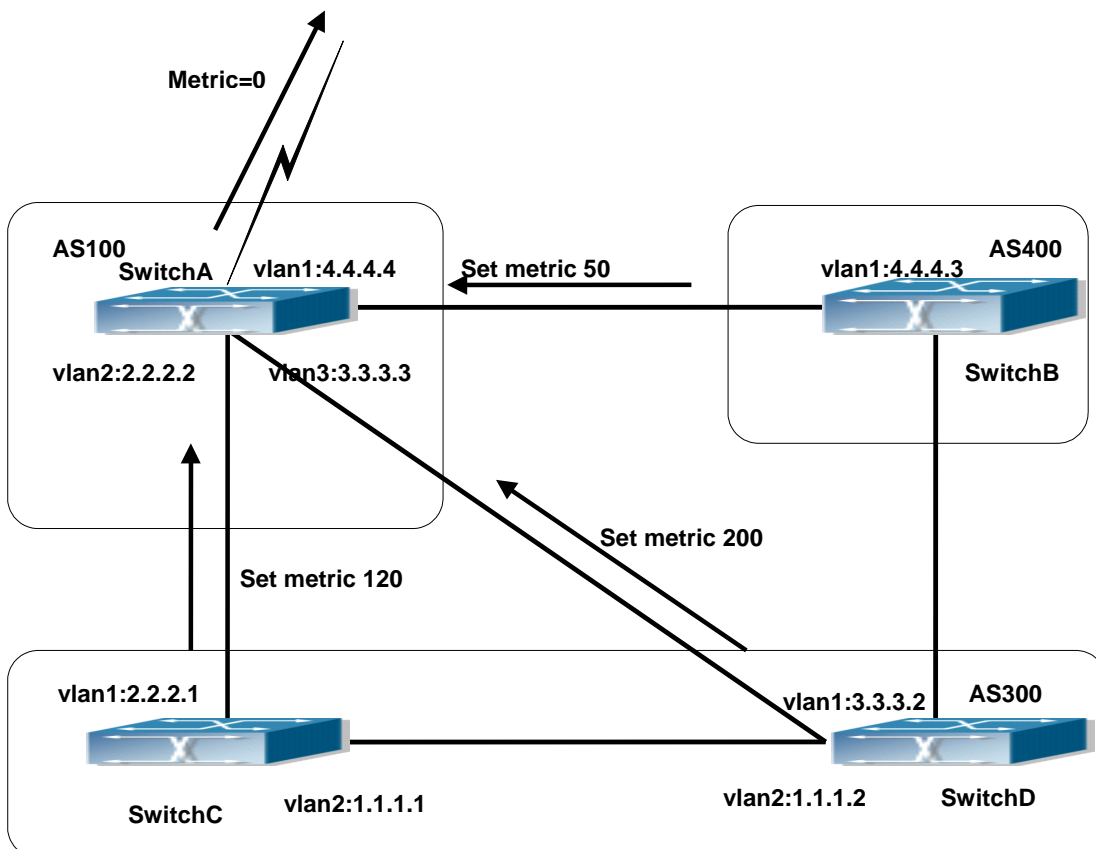

**Figure 40-4** MED Configuring Topological Map

---

### The configurations of SwitchA:

```
SwitchA(config)#router bgp 100
SwitchA(config-router-bgp)#neighbor 2.2.2.1 remote-as 300
SwitchA(config-router-bgp)#neighbor 3.3.3.2 remote-as 300
SwitchA(config-router-bgp)#neighbor 4.4.4.3 remote-as 400
```

### The configurations of SwitchC:

```
SwitchC(config)#router bgp 300
SwitchC (config-router-bgp)#neighbor 2.2.2.2 remote-as 100
SwitchC (config-router-bgp)#neighbor 2.2.2.2 route-map set-metric out
SwitchC (config-router-bgp)#neighbor 1.1.1.2 remote-as 300
SwitchC (config-router-bgp)#exit
SwitchC (config)#route-map set-metric permit 10
SwitchC (Config-Router-RouteMap)#set metric 120
```

### The configurations of SwitchD

```
SwitchD (config)#router bgp 300
SwitchD (config-router-bgp)#neighbor 3.3.3.3 remote-as 100
SwitchD (config-router-bgp)#neighbor 3.3.3.3 route-map set-metric out
SwitchD (config-router-bgp)#neighbor 1.1.1.1 remote-as 300
SwitchD (config-router-bgp)#exit
SwitchD (config)#route-map set-metric permit 10
SwitchD (Config-Router-RouteMap)#set metric 200
```

### The configurations of SwitchB

```
SwitchB (config)#router bgp 400
SwitchB (config-router-bgp)#neighbor 4.4.4.4 remote-as 100
SwitchB (config-router-bgp)#neighbor 4.4.4.4 route-map set-metric out
SwitchB (config-router-bgp)#exit
SwitchB (config)#route-map set-metric permit 10
SwitchB (Config-Router-RouteMap)#set metric 50
```

After the configuration above, SwitchB, SwitchC and SwitchD are assumed to send a route 12.0.0.0 to SwitchA. According to the comparison of BGP route strategy; there is an assumption that the routes sent by the three switches above have the same attribute value before the comparison of metric attribute. At this time, the route with lower value is the better route. But the comparison of metric attribute will only be done with the routes from the same AS. For SwitchA, the routes passed SwitchC are preferable to the one passed SwitchD. Because SwitchC and SwitchB are not located in the same AS, the SwitchA will not do metric comparison between the two switches. If the metric comparison between different AS is needed, the command " bgp always-compare-med" will be used. If this command is configured, the routes passed SwitchB are the best to SwitchA. At this time, the following command may be added on SwitchA:

```
SwitchA (config-router-bgp)#bgp always-compare-med
```

### 40.3.7 Examples 7: example of BGP VPN

For the configuration of MPLS VPN, BGP is part of the core routing system and it is also an important utility to support ILM and FTN entries on the edge devices. For DCNOS, the BGP protocol together with the LDP protocol, constructs the foundation of the MPLS VPN application. The LDP protocol works at the WLAN side and for the routers which are not on the edge of the network, the BGP protocol does not function.

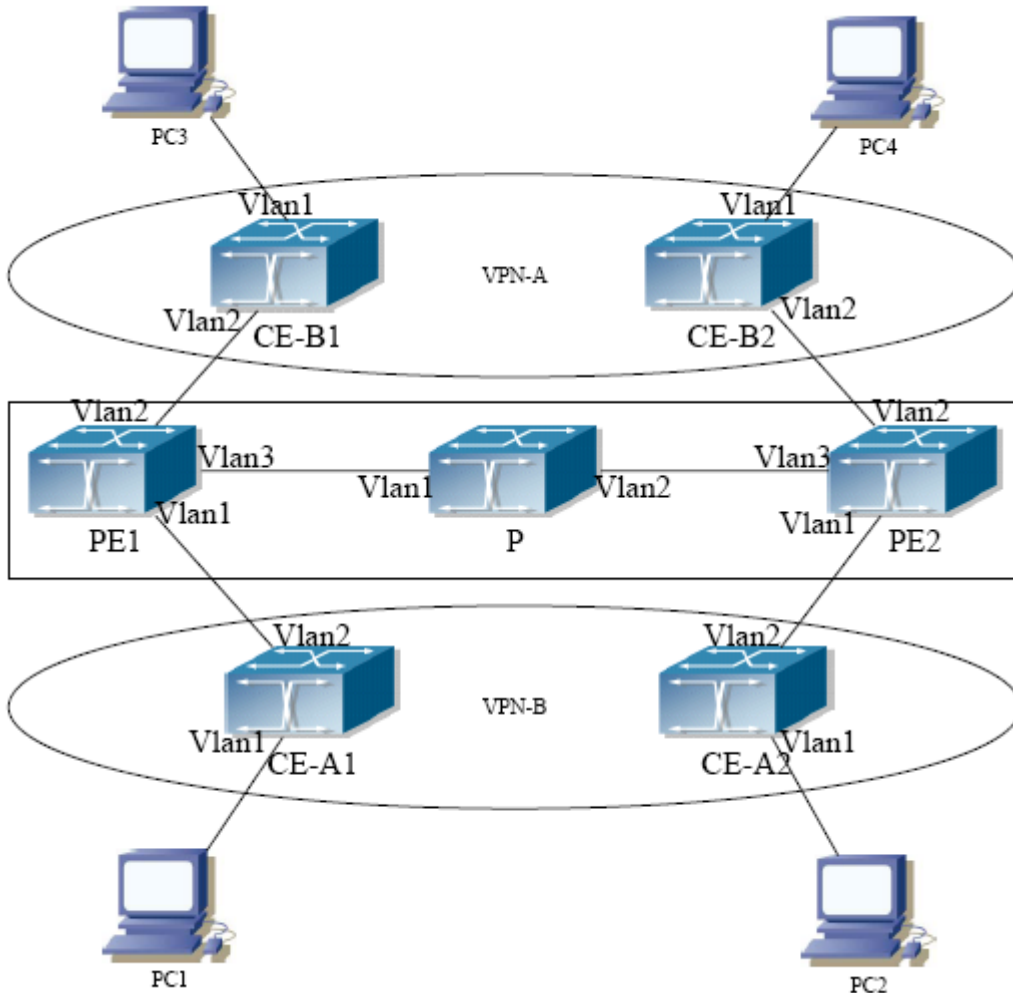

Figure 40-5 Example of MPLS VPN

As the figure shows, for a typical MPLS VPN application, the public network region consists of PE1, P and PE2, which MPLS is applied for packet transmission. VPN-A consists of CE-A1 and CE-A2, and VPN-B consists of CE-B1 and CE-B2. These two VPNs are isolated from each other. PE1 and PE2 are edge routers which are provided by the operators. CE-A1, CE-A2, CE-B1 and CE-B2 are the access switches on the user side. PC1-PC4 indicate the network users. BGP runs at both the public and private network region. For the public network region, VPN routing should be supported and the LOOPBACK interface should be used for connections.

The sample configurations are listed as below.

#### Configurations on CE-A1 :

```
CE-A1#config
```

```
CE-A1(config)#interface vlan 2
CE-A1(config-if-Vlan2)#ip address 192.168.101.2 255.255.255.0
CE-A1(config-if-Vlan2)#exit
CE-A1(config)#interface vlan 1
CE-A1(config-if-Vlan2)#ip address 10.1.1.1 255.255.255.0
CE-A1(config-if-Vlan2)#exit
CE-A1(config)#router bgp 60101
CE-A1(config-router)#neighbor 192.168.101.1 remote-as 100
CE-A1(config-router)#exit
```

#### **Configurations on CE-A2 :**

```
CE-A2#config
CE-A2(config)#interface vlan 2
CE-A2(config-if-Vlan2)#ip address 192.168.102.2 255.255.255.0
CE-A2(config-if-Vlan2)#exit
CE-A2(config)#interface vlan 1
CE-A2(config-if-Vlan2)#ip address 10.1.2.1 255.255.255.0
CE-A2(config-if-Vlan2)#exit
CE-A2(config)#router bgp 60102
CE-A2(config-router)#neighbor 192.168.102.1 remote-as 100
CE-A2(config-router)#exit
```

#### **Configurations on CE-B1 :**

```
CE-B1#config
CE-B1(config)#interface vlan 2
CE-B1(config-if-Vlan2)#ip address 192.168.201.2 255.255.255.0
CE-B1(config-if-Vlan2)#exit
CE-B1(config)#interface vlan 1
CE-B1(config-if-Vlan2)#ip address 20.1.1.1 255.255.255.0
CE-B1(config-if-Vlan2)#exit
CE-B1(config)#router bgp 60201
CE-B1(config-router)#neighbor 192.168.201.1 remote-as 100
CE-B1(config-router)#exit
```

#### **Configurations on CE-BE2 :**

```
CE-B2#config
CE-B2(config)#interface vlan 2
CE-B2(config-if-Vlan2)#ip address 192.168.202.2 255.255.255.0
CE-B2(config-if-Vlan2)#exit
CE-B2(config)#interface vlan 1
CE-B2(config-if-Vlan2)#ip address 20.1.2.1 255.255.255.0
CE-B2(config-if-Vlan2)#exit
CE-B2(config)#router bgp 60202
```

```
CE-B2(config-router)#neighbor 192.168.202.1 remote-as 100
CE-B2(config-router)#exit
```

### Configurations on PE1 :

```
PE1#config
PE1(config)#ip vrf VRF-A
PE1(config-vrf)#rd 100:10
PE1(config-vrf)#route-target both 100:10
PE1(config-vrf)#exit
PE1(config)#ip vrf VRF-B
PE1(config-vrf)#rd 100:20
PE1(config-vrf)#route-target both 100:20
PE1(config-vrf)#exit
PE1(config)#interface vlan 1
PE1(config-if-Vlan1)#ip vrf forwarding VRF-A
PE1(config-if-Vlan1)#ip address 192.168.101.1 255.255.255.0
PE1(config-if-Vlan1)#exit
PE1(config)#interface vlan 2
PE1(config-if-Vlan2)#ip vrf forwarding VRF-B
PE1(config-if-Vlan2)#ip address 192.168.201.1 255.255.255.0
PE1(config-if-Vlan2)#exit
PE1(config)#interface vlan 3
PE1(config-if-Vlan3)#ip address 202.200.1.2 255.255.255.0
PE1(config-if-Vlan3)#label-switching
PE1(config-if-Vlan3)#exit
PE1(config)#interface loopback 1
PE1(Config-if-Loopback1)# ip address 200.200.1.1 255.255.255.255
PE1(config-if-Vlan3)#exit
PE1(config)#router bgp 100
PE1(config-router)#neighbor 200.200.1.2 remote-as 100
PE1(config-router)#neighbor 200.200.1.2 update-source 200.200.1.1
PE1(config-router)#address-family vpnv4 unicast
PE1(config-router-af)#neighbor 200.200.1.2 activate
PE1(config-router-af)#exit-address-family
PE1(config-router)#address-family ipv4 vrf VRF-A
PE1(config-router-af)# neighbor 192.168.101.2 remote-as 60101
PE1(config-router-af)#exit-address-family
PE1(config-router)#address-family ipv4 vrf VRF-B
PE1(config-router-af)# neighbor 192.168.201.2 remote-as 60201
PE1(config-router-af)#exit-address-family
```

## Configurations on PE2 :

```
PE2#config
PE2(config)#ip vrf VRF-A
PE2(config-vrf)#rd 100:10
PE2(config-vrf)#route-target both 100:10
PE2(config-vrf)#exit
PE2(config)#ip vrf VRF-B
PE2(config-vrf)#rd 100:20
PE2(config-vrf)#route-target both 100:20
PE2(config-vrf)#exit
PE2(config)#interface vlan 1
PE2(config-if-Vlan1)#ip vrf forwarding VRF-A
PE2(config-if-Vlan1)#ip address 192.168.102.1 255.255.255.0
PE2(config-if-Vlan1)#exit
PE2(config)#interface vlan 2
PE2(config-if-Vlan2)#ip vrf forwarding VRF-B
PE2(config-if-Vlan2)#ip address 192.168.202.1 255.255.255.0
PE2(config-if-Vlan2)#exit
PE2(config)#interface vlan 3
PE2(config-if-Vlan3)#ip address 202.200.2.2 255.255.255.0
PE2(config-if-Vlan3)#label-switching
PE2(config-if-Vlan3)#exit
PE2(config)#interface loopback 1
PE2(Config-if-Loopback1)# ip address 200.200.1.2 255.255.255.255
PE2(config-if-Vlan3)#exit
PE2(config)#router bgp 100
PE2(config-router)#neighbor 200.200.1.1 remote-as 100
PE2(config-router)#address-family vpnv4 unicast
PE2(config-router-af)#neighbor 200.200.1.1 activate
PE2(config-router-af)#exit-address-family
PE2(config-router)#address-family ipv4 vrf VRF-A
PE2(config-router-af)# neighbor 192.168.102.2 remote-as 60102
PE2(config-router-af)#exit-address-family
PE2(config-router)#address-family ipv4 vrf VRF-B
PE2(config-router-af)# neighbor 192.168.202.2 remote-as 60202
PE2(config-router-af)#exit-address-family
```

The sample configurations which are listed above is the most typical one. To enable communication between VRF, the route-target should be modified. And if the BGP AS number duplicates for the ends, the “**neighbor <ip-addr> as-override**” command should be configured to avoid the duplication of AS numbers. Also, only BGP related configuration are listed above, to run LDP on the public network region, please refer to the LDP configuration sample.



---

## 40.4 BGP Troubleshooting

In the process of configuring and implementing BGP protocol, physical connection, configuration false probably leads to BGP protocol doesn't work. Therefore, the customers should give their attention to points as follow:

- First of all, to ensure correct physical connection;
- Secondly, to ensure interface and link protocol are UP (execute **show interface** instruction);
- And startup BGP protocol (use **router bgp** command), configure affiliated IBGP and EBGP neighbors (use **neighbor remote-as** command).
- Notice BGP protocol itself can't detect route, needs to import other routes to create BGP route. Only it enables these routes to announce IBGP and EBGP neighbors by importing routes. Direct-link routes, static route, and IGP route (RIP and OSPF) are included in these imported routes. **network** and **redistribute (BGP)** command are the ways of imported routes.
- For BGP, pay attention to the difference between the behaviors of IBGP and EBGP.
- After configuration finishes, the command of **show ip bgp summary** can be used to observe neighbor's connections, so that all of the neighbors keep BGP connection situation. And use **show ip bgp** command to observe BGP routing table.
- If BGP routing problem still can't be solved by debugging, please use debug instructions like **debug ip bgp** packet/events etc, and copy DEBUG information in 3 minutes, then send them to our Technology Service Center.

---

# Chapter 41 MBGP4+

## 41.1 Introduction to MBGP4+

MBGP4+ is multi-protocol BGP (Multi-protocol Border Gateway Protocol) extension to IPv6, referring to BGP protocol chapter about BGP protocol introduction in this manual. Different from RIPng and OSPFv3, BGP has no corresponding independent protocol for IPv6, instead, it takes extensions to address families on the original BGP. The extensions to BGP by MBGP4+ are mostly embodied:

- a. neighbor address configured can be IPv6 address;
- b. Increase IPv6 unicast address family configuration.

## 41.2 MBGP4+ Configuration Task List

MBGP4+ Configuration Task List::

1. Configure IPv6 neighbor
2. Configure and enable IPv6 address family
3. Configure redistribution of OSPFv3 routing to MBGP4+
  - 1) Enable redistribution of OSPFv3 routing to MBGP4+
  - 2) Display and debug the information about configuration of redistribution of OSPFv3 routing to MBGP4+

### 1. Configure IPv6 neighbor

Command	Explanation
BGP Protocol Configuration Mode	
<b>neighbor &lt;X:X::X:X&gt; remote-as &lt;as-id&gt;</b>	Configure IPv6 neighbor.

### 2. Configure and activate IPv6 address family

Command	Explanation
BGP Protocol Configuration Mode	
<b>address-family IPv6 unicast</b>	Enter IPv6 unicast address family.
BGP protocol address family configuration mode	
<b>neighbor &lt;X:X::X:X&gt; activate</b> <b>no neighbor &lt;X:X::X:X&gt; activate</b>	Configure IPv6 neighbor to activate/inactivate the address family.
<b>exit-address-family</b>	Exit address family configuration mode.

### 3. Configure redistribution of OSPFv3 routing to MBGP4+

(1) Enable redistribution of OSPFv3 routing to MBGP4+

Command	Explanation
Router IPv6 BGP Configuration Mode	
<b>redistribute ospf [&lt;process-tag&gt;] [route-map&lt;word&gt;] no redistribute ospf [&lt;process-tag&gt;]</b>	To enable or disable redistribution of OSPFv3 routing to MBGP4+.

(2) Display and debug the information about configuration of redistribution of OSPFv3 routing to MBGP4+

Command	Explanation
Admin Mode and Configuration Mode	
<b>show ipv6 bgp redistribute</b>	To display configuration information about MBGP4+ routing which is redistributed from other routing protocols.
Admin Mode	
<b>debug ipv6 bgp redistribute message send no debug ipv6 bgp redistribute message send debug ipv6 bgp redistribute route receive no debug ipv6 bgp redistribute route receive</b>	To enable or disable debugging messages sent by MBGP4+ for redistribution of OSPFv3 routing. To enable or disable debugging messages received from NSM.

## 41.3 MBGP4+ Examples

SwitchB, SwitchC and SwitchD are in AS200, SwitchA is in AS100. SwitchA and SwitchB share the same network segment. SwitchB and SwitchD are not connected physically.

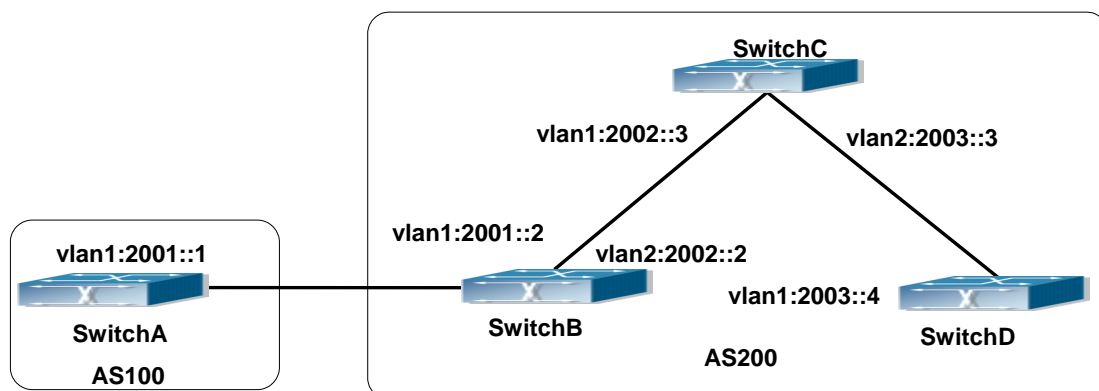

Figure 41-1 BGP Network Topological Map

---

Accordingly SwitchA configuration as follows:

```
SwitchA(config)#router bgp 100
SwitchA(config-router)#bgp router-id 1.1.1.1
SwitchA(config-router)#neighbor 2001::2 remote-as 200
SwitchA(config-router)#address-family IPv6 unicast
SwitchA(config-router-af)#neighbor 2001::2 activate
SwitchA(config-router-af)#exit-address-family
SwitchA(config-router-bgp)#exit
SwitchA(config)#
```

SwitchB configuration as follows:

```
SwitchB(config)#router bgp 200
SwitchA(config-router)#bgp router-id 2.2.2.2
SwitchB(config-router)#neighbor 2001::1 remote-as 100
SwitchB(config-router)#neighbor 2002::3 remote-as 200
SwitchB(config-router)#neighbor 2003::4 remote-as 200
SwitchB(config-router)#address-family IPv6 unicast
SwitchB(config-router-af)#neighbor 2001::1 activate
SwitchB(config-router-af)#neighbor 2002::3 activate
SwitchB(config-router-af)#neighbor 2003::4 activate
SwitchB(config-router-af)#exit-address-family
SwitchB(config-router)#exit
SwitchB(config)#
```

SwitchC configuration as follows:

```
SwitchC(config)#router bgp 200
SwitchA(config-router)#bgp router-id 2.2.2.2
SwitchC(config-router)#neighbor 2002::2 remote-as 200
SwitchC(config-router)#neighbor 2003::4 remote-as 200
SwitchC(config-router)#address-family IPv6 unicast
SwitchC(config-router-af)#neighbor 2002::2 activate
SwitchC(config-router-af)#neighbor 2003::4 activate
SwitchC(config-router-af)#exit-address-family
SwitchC(config-router-bgp)#exit
```

SwitchD configuration as follows:

```
SwitchD(config)#router bgp 200
SwitchA(config-router)#bgp router-id 2.2.2.2
SwitchD(config-router)#neighbor 2003::3 remote-as 200
SwitchD(config-router)#neighbor 2002::2 remote-as 200
SwitchD(config-router)#address-family IPv6 unicast
SwitchD(config-router-af)#neighbor 2002::2 activate
SwitchD(config-router-af)#neighbor 2003::3 activate
```

```
SwitchD(config-router-af)#exit-address-family
SwitchD(config-router)#exit
```

Here the connection between SwitchB and SwitchA is EBGP, and the connection between SwitchC and SwitchD is IBGP. The BGP connection can be processed between SwitchB and SwitchD without physical link, but the premise is a route which reaches from one switch to the other switch. The route can be obtained by static routing or IGP.

## 41.4 MBGP4+ Troubleshooting

It is the same as corresponding section of BGP.

---

# Chapter 42 Black Hole Routing Manual

## 42.1 Introduction to Black Hole Routing

Black Hole Routing is a special kind of static routing which drops all the datagrams that match the routing rule.

## 42.2 IPv4 Black Hole Routing Configuration Task

### 1. Configure IPv4 Black Hole Routing

Command	Explanation
Global Configuration Mode	
<code>ip route {&lt;ip-prefix&gt; &lt;mask&gt;/&lt;ip-prefix&gt;/&lt;prefix-length&gt;} null0 [&lt;distance&gt;] no ip route {&lt;ip-prefix&gt; &lt;mask&gt;/&lt;ip-prefix&gt;/&lt;prefix-length&gt;} null0</code>	To configure the static Black Hole Routing. The no form of this command will remove the specified Black Hole Routing configuration.

## 42.3 IPv6 Black Hole Routing Configuration Task

1. Enable the IPv6 function
2. Configure the IPv6 Black Hole Routing

### 1. Enable the IPv6 function

Command	Explanation
Global Configuration Mode	
<code>ipv6 enable</code>	To enable the IPv6 function on the switch.

### 2. Configure IPv6 Black Hole Routing

Command	Explanation
Global Configuration Mode	
<code>ipv6 route &lt;ipv6-prefix/prefix-length&gt; null0 [&lt;precedence&gt;] no ipv6 route &lt;ipv6-prefix/prefix-length&gt; null0</code>	To configure static IPv6 Black Hole Routing. The no form of this command will remove the specified configuration.

## 42.4 Black Hole Routing Configuration Examples

Example 1: IPv4 Black Hole Routing function.

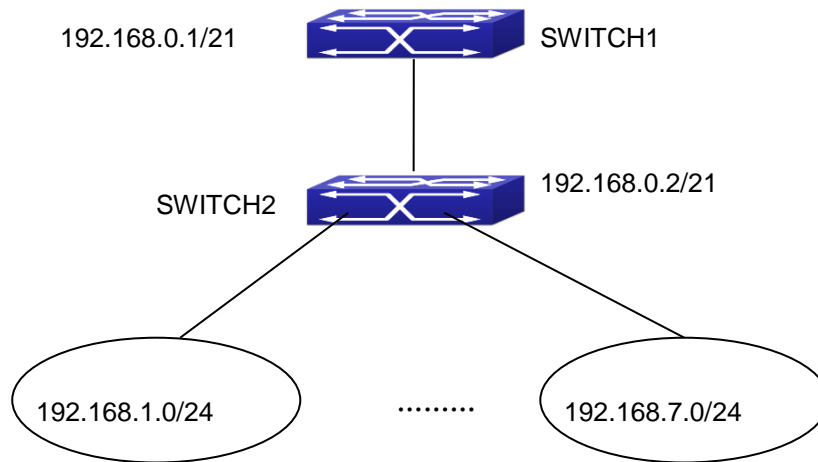

**Figure 42-1** IPv4 Black Hole Routing Configuration Example

As it is shown in the figure, in Switch 2, eight in all interfaces are configured as Layer 3 VLAN interfaces for access interfaces. The network addresses are 192.168.1.0/24 ~ 192.268.7.0/24. A default routing is configured on Switch 2 to connect to Switch 1. And a backward default routing is configured on Switch 1 to Switch 2, whose network address is 192.168.0.0/21. Commonly, this configuration will work well. However, if one of the Layer 3 interfaces in Switch 2 goes down, for example, the interface belonged to 192.168.1.0/24. When datagrams arrives at VLAN1 in Switch 2, there will be no routing rules for these datagrams. The switch then will forward these datagrams according to the default routing, back to Switch 1. When Switch 1 receives these datagrams, it will forward them back to Switch 2. Thus, loopback exists. To solve this problem, Black Hole Routing can be introduced on Switch 2.

```
ip route 192.168.0.0/21 null0 50
```

Then Switch 2 will drop the datagrams from interface VLAN1 that match the Black Hole Routing rule. And loopback routing is prevented.

Configuration steps are listed as below:

```
Switch#config
Switch(config)#ip route 192.168.0.0/21 null0 50
```

---

Example 2: IPv6 Black Hole Routing function.

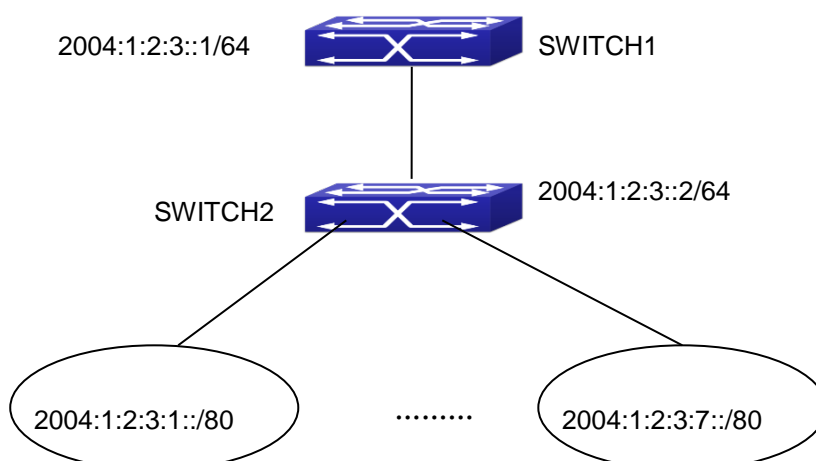

**Figure 41-2** IPv6 Black Hole Routing Configuration Example

As it is shown in the figure, in Switch 2, eight in all interfaces are configured as Layer 3 VLAN interfaces for access interfaces. The network addresses are 2004:1:2:3:1/80~2004:1:2:3:7/80. A default routing is configured on Switch 2 to connect to Switch 1. And a backward default routing is configured on Switch 1 to Switch 2, whose network address is 2004:1:2:3::/64. Commonly, this configuration will work well. However, if one of the Layer 3 interfaces in Switch 2 goes down, for example, the interface belonged to 2004:1:2:3:1/80. When datagrams arrives at VLAN1 in Switch 2, there will be no routing rules for these datagrams. The switch then will forward these datagrams according to the default routing, back to Switch 1. When Switch 1 receives these datagrams, it will forward them back to Switch 2. Thus, loopback exists. To solve this problem, Black Hole Routing can be introduced on Switch 2.

```
ipv6 route 2004:1:2:3::/64 null0 50
```

Then Switch 2 will drop the datagrams from interface VLAN1 that match the Black Hole Routing rule. And loopback routing is prevented.

Configuration steps are listed as below:

```
Switch#config
Switch(config)#ipv6 route 2004:1:2:3::/64 null0 50
```

## 42.5 Black Hole Routing Troubleshooting

When configuring the Black Hole Routing function, the configuration may not work due to some reasons such as incorrect network address mask, and incorrect management distance. Attention should be paid to the following items:

- IPv6 should be enabled before IPv6 Black Hole Routing can work.
- It is suggested that the length of the network address mask should be longer than that of normal routing configuration, in order to prevent the Black Hole Routing from intervening other routing configuration.
- When the network address mask of Black Hole Routing configuration is the same with some other configuration, it is suggested that the distance of Black Hole Routing is set lower.



---

For problems that cannot be fixed through above methods, please issue the command show ip route distance and show ip route fib, and show I3. And copy and paste the output of the commands, and send to the technical service center of our company.

---

# Chapter 43 GRE Tunnel Configuration

## 43.1 Introduction to GRE Tunnel

GRE (General Routing-protocol Encapsulation) was referred to IETF by Cisco and Net-smiths companies in 1994, in RFC1701 and RFC1702. At present, the network devices of the most manufacturers support the GRE tunnel protocol. GRE set how to encapsulate a kind of network protocol in other kind of network protocol. The GRE tunnel is defined by the source IP address and the destination IP address of two ends, it allows that users can use IP packets to encapsulate IP, IPX, AppleTalk packets, and supports all routing protocols (such as RIP2, OSPF, etc). By GRE, users can use the public IP network to connect IPX network, AppleTalk network, and use the reserved address to connect through the internet work, or hide the IP address of the corporation network to the public network. GRE only provides the encapsulation of the data packets, and has no encryption function to avoid the network interception and attack. Therefore, it is used with IPsec usually in the actual environment, and IPsec provides the data encryption to supply very good security for users.

The most use of GRE protocol: the internal protocol encapsulation and the private address encapsulation of the enterprise. In our nation, the enterprise network almost adopts TCP/IP protocol, so there are fewer requirements to the internal protocol encapsulation. The enterprise use GRE almost for encapsulating the private address .In our switches, the GRE is used mainly for the transition of the network protocol (include IPv6 OVER IPv4 and IPv4 OVER IPv6).

RFC1701, 1702, 2784 are referred for the implement.

## 43.2 GRE Tunnel Basic Configuration

GRE Tunnel Configuration Task List:

1. Configure tunnel mode
  - 1) Configure tunnel mode as GREv4 tunnel
  - 2) Configure tunnel mode as GREv6 tunnel
2. Configure the source address and the destination address of GRE tunnel
  - 1) Configure the source address as the IPv6 or IPv4 address for GRE tunnel
  - 2) Configure the destination address as the IPv6 or IPv4 address for GRE tunnel
3. Configure the interface address of GRE tunnel
  - 1) Configure the IPv4 address of GRE tunnel interface
  - 2) Configure the IPv6 address of GRE tunnel interface
4. Configure the egress interface of the static route as GRE tunnel
  - 1) Configure the egress interface of the IPv4 static route to GRE tunnel
  - 2) Configure the egress interface of the IPv6 static route to GRE tunnel

### 1. Configure tunnel mode

Command	Explanation
Tunnel interface configuration mode	
<b>tunnel mode gre ip</b> <b>no tunnel mode</b>	Configure the tunnel mode as GREv4 tunnel. After the data packet is encapsulated with GRE, it has a head of IPv4 packets, and passes the IPv4 network.
<b>tunnel mode gre ipv6</b> <b>no tunnel mode</b>	Configure the tunnel mode as GREv6 tunnel. After the data packet is encapsulated with GRE, it has the head of IPv6 packets, and passes the IPv6 network.

### 2. Configure the source address and the destination address of GRE tunnel

Command	Explanation
Tunnel interface configuration mode	
<b>tunnel source {&lt;ipv6-address&gt;   &lt;ipv4-address&gt;}</b> <b>no tunnel source</b>	Configure the source address as the IPv6 or IPv4 address for GRE tunnel.
<b>tunnel destination {&lt;ipv6-address&gt;   &lt;ipv4-address&gt;}</b> <b>no tunnel destination</b>	Configure the destination address as the IPv6 or IPv4 address for GRE tunnel.

### 3. Configure the interface address of GRE tunnel

Command	Explanation
Tunnel interface configuration mode	
<b>ip address &lt;ipv4-address&gt; &lt;mask&gt;</b> <b>no ip address &lt;ipv4-address&gt; &lt;mask&gt;</b>	Configure the IPv4 address of GRE tunnel interface.
<b>ipv6 address &lt;ipv6-address/prefix&gt;</b> <b>no ipv6 address &lt;ipv6-address/prefix&gt;</b>	Configure the IPv6 address of GRE tunnel interface.

### 4. Configure the egress interface of the static route as GRE tunnel

Command	Explanation
Global Mode	

<pre>ip route &lt;ipv4-address/mask&gt;   tunnel &lt;ID&gt; no ip route &lt;ipv4-address/mask&gt;   tunnel &lt;ID&gt;</pre>	<p>Configure the egress interface of the IPv4 static route to GRE tunnel.</p>
<pre>ipv6 route &lt;ipv6-address/prefix&gt;   tunnel &lt;ID&gt; no ipv6 route   &lt;ipv6-address/prefix&gt; tunnel &lt;ID&gt;</pre>	<p>Configure the egress interface of the IPv6 static route to GRE tunnel.</p>

## 43.3 Example of GRE Tunnel

The Typical Example of GRE Tunnel:

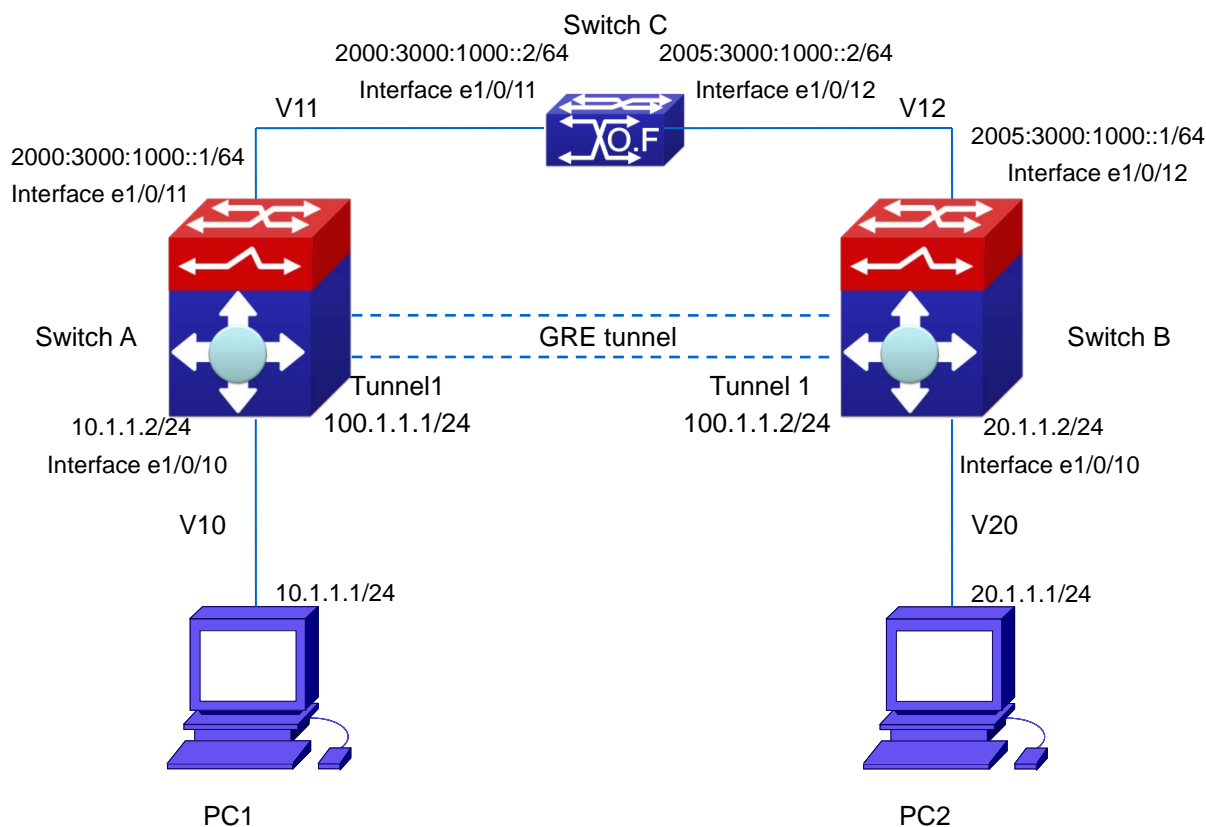

Figure 43-1 the typical network of IPv4 over IPv6 GRE tunnel character

### Configuration summary:

- Configure IPv6 network, and ensure IPv6 connectivity.
- Configure the tunnel interface, and the interface that connect PC.
- Configure the tunnel parameters and enable the tunnel interface.
- Enable OSPF route protocol to forward the data between PC1 and PC2 through the tunnel.

---

## Configuration steps

Instruction: the topology environment of this chapter may be different to the actual environment. To ensure the effect of the configuration, please make sure the current configuration of the device does not conflict with the following configuration.

(1) The configuration of device A

1. The configuration step

- Enable IPv6 function.

```
SwitchA(config)#ipv6 enable
```

- Create the interface VLAN 11 and its address.

```
SwitchA(config)#vlan 11
SwitchA(config-vlan11)#switchport interface ethernet 1/0/11
SwitchA(config-vlan11)#exit
SwitchA(config)#interface vlan 11
SwitchA(config-if-vlan11)#ipv6 address 2000:3000:1000::1/64
```

- Configure the IPv6 static route to switch B from interface Vlan11.

```
SwitchA(config)#ipv6 route 2005:3000:1000::1/64 2000:3000:1000::2
```

- Configure tunnel interface: source, destination and type. After the tunnel is enabled, its source address and destination address can not be modified except the source address as the layer 3 interface.

```
SwitchA(config)#interface tunnel 1
SwitchA(config-if-tunnel1)# tunnel source 2000:3000:1000::1
SwitchA(config-if-tunnel1)# tunnel destination 2005:3000:1000::1
SwitchA(config-if-tunnel1)# tunnel mode gre ipv6
SwitchA#show gre tunnel
name          mode          source          destination
Tunnel1       gre ipv6      2000:1000:3000::1  2005:1000:3000::1
The configuration of GRE tunnel is successful.
```

- Configure the IPv4 address of the tunnel interface. Only one interface address can be configured for the tunnel interface, and this limitation will also be used to other tunnels, such as configure tunnel, 6to4, isatap.
- Notice: the tunnel must stays in active state when configuring IPv4 address, but configure IPv6 address is different to IPv4 address.

```
SwitchA (config-if-tunnel1)#ip address 100.1.1.1 255.255.255.0
```

- Configure the interface VLAN10 and its address.

```
SwitchA(config)#vlan 10
SwitchA(config-vlan10)#switchport interface ethernet 1/0/10
SwitchA(config-vlan10)#exit
```

```
SwitchA(config)#interface vlan 10
SwitchA(config-if-vlan10)# ip address 10.1.1.2 255.255.255.0
SwitchA(config-if-vlan10)#exit
```

- Configure OSPF routing protocol.

```
SwitchA(config)#router ospf
SwitchA(config-router)#router-id 1.1.1.1
SwitchA(config-router)#network 100.1.1.0/24 area 0
SwitchA(config-router)#network 10.1.1.0/24 area 0
SwitchA(config-router)#exit
```

After the OSPF protocol of two ends are fully connected through the tunnel, we can see the tunnel route

```
SwitchA(config)#show ip route
O      20.1.1.0/24 [110/2] via 100.1.1.1, Tunnel1, 01:41:49 tag:0
```

(2) The configuration of device B

1. The configuration step

- Enable IPv6 function.

```
SwitchA(config)#ipv6 enable
```

- Create the interface VLAN 12 and its address.

```
SwitchA(config)#vlan 12
SwitchA(config-vlan12)#switchport interface ethernet 1/0/12
SwitchA(config-vlan12)#exit
SwitchA(config)#interface vlan 12
SwitchA(config-if-vlan12)#ipv6 address 2005:3000:1000::1/64
SwitchA(config-if-vlan12)#exit
SwitchA(config)#
```

- Configure the IPv6 static route to Switch A from interface Vlan12.

```
SwitchA(config)#ipv6 route 2000:3000:1000::1/64 2005:3000:1000::2
```

- Configure tunnel interface: source, destination and type.

```
SwitchA(config)#interface tunnel 1
SwitchA(config-if-tunnel1)# tunnel source 2005:3000:1000::1
SwitchA(config-if-tunnel1)# tunnel destination 2000:3000:1000::1
SwitchA(config-if-tunnel1)# tunnel mode gre ipv6
SwitchA#show gre tunnel
```

name	mode	source	destination
------	------	--------	-------------

```
Tunnel1      gre ipv6      2005:1000:3000::1      2000:1000:3000::1
The configuration of GRE tunnel is successful.
```

- Configure the IPv4 address of the tunnel interface. To run OSPF routing protocol, the interface address must be configured.

```
SwitchA (config-if-tunnel1)#ip address 100.1.1.2 255.255.255.0
```

- Configure the interface VLAN20 and its address.

```
SwitchA(config)#vlan 20
SwitchA(config-vlan20)#switchport interface ethernet 1/0/10
SwitchA(config-vlan20)#exit
SwitchA(config)#interface vlan 20
SwitchA(config-if-vlan20)# ip address 20.1.1.2 255.255.255.0
SwitchA(config-if-vlan20)#exit
SwitchA(config)#
```

- Configure OSPF routing protocol.

```
SwitchA(config)#router ospf
SwitchA(config-router)#router-id 1.1.1.2
SwitchA(config-router)#network 100.1.1.0/24 area 0
SwitchA(config-router)#network 20.1.1.0/24 area 0
SwitchA(config-router)#exit
SwitchA(config)#
```

After the OSPF protocols of two ends are fully connected through the tunnel, we can see the tunnel route

```
SwitchB(config)#show ip route
O      10.1.1.0/24 [110/2] via 100.1.1.2, Tunnel1, 01:41:49 tag:0
```

### (3) The configuration of device C

#### 1. The configuration step

- Enable IPv6 function.

```
SwitchA(config)#ipv6 enable
```

- Create the interface VLAN 11 and its address.

```
SwitchA(config)#vlan 11
SwitchA(config-vlan11)#switchport interface ethernet 1/0/11
SwitchA(config-vlan11)#exit
SwitchA(config)#interface vlan 11
SwitchA(config-if-vlan11)#ipv6 address 2000:3000:1000::2/64
```

- 
- Create the interface VLAN 12 and its address

```
SwitchA(config)#vlan 12
SwitchA(config-vlan12)#switchport interface ethernet 1/0/12
SwitchA(config-vlan12)#exit
SwitchA(config)#interface vlan 12
SwitchA(config-if-vlan12)#ipv6 address 2005:3000:1000::2/64
SwitchA(config-if-vlan12)#exit
```

(4) The configuration of PC

- Configure the IP address of PC1 and the default gateway.

PC1: the IP address: 10.1.1.1 255.255.255.0, the default gateway: 10.1.1.2

PC2: the IP address: 20.1.1.1 255.255.255.0, the default gateway: 20.1.1.2

## 43.4 Example of GRE Tunnel Quotes Loopback Group

### Introduction to loopback group

When the cards with different types are inserted to a device, implement the redirection between the different cards through loopback function, such as: the cards whether support GRE tunnel are inserted, so the GRE tunnel data received by the cards (do not support GRE tunnel) to be processed to the supporting GRE tunnel cards. A loopback group uses the (one or several) card's ports without any configuration. To increase the redirection bandwidth between the cards, join many ports in a loopback group to implement the load balance.

### Example of GRE tunnel quotes loopback group



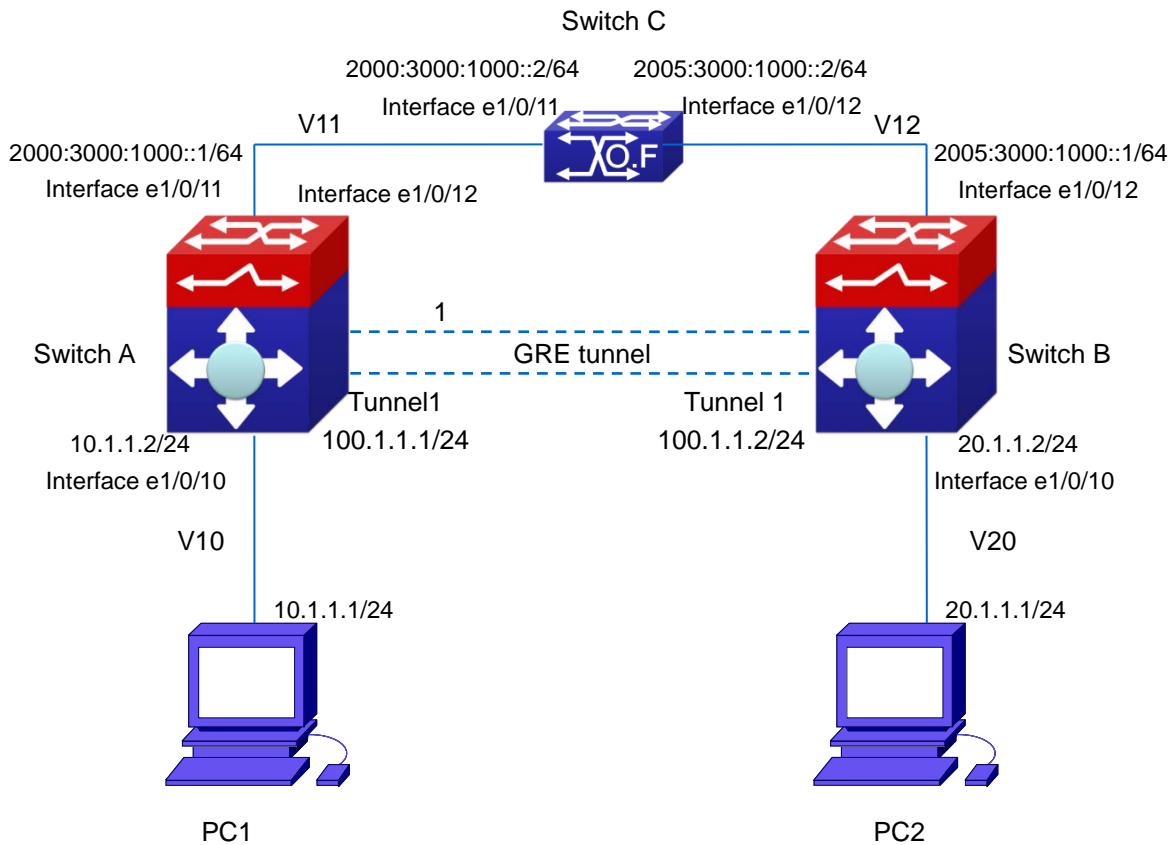

**Figure 43-2** GRE tunnel quotes loopback group topology

### Introduction to loopback group topology

IPv6 network between SwitchA and SwitchB, PC1 and PC2 at IPv4 network, so PC1 must pass IPv6 network between SwitchA and SwitchB to communicate with PC2 through GRE tunnel. The cards with different types may be inserted to SwitchA, card 1 does not support GRE tunnel, card 3 supports GRE tunnel, so the data received by card 1 needs to be processed to card 3 through loopback group function.

### Configuration summary:

- Configure IPv6 network, and ensure IPv6 connectivity.
- Configure the tunnel interface, and the interface that connect PC.
- Configure the tunnel parameters and enable the tunnel interface.
- Configure loopback group, join port 1/0/12 of the card 3 in this loopback group and enable the tunnel to quote this loopback group.
- Enable OSPF route protocol to forward the data between PC1 and PC2 through the tunnel.

### Configuration steps

Instruction: the topology environment of this chapter may be different to the actual environment. To ensure the effect of the configuration, please make sure the current configuration of the device does not conflict with the following configuration.

---

(1) The configuration of device A

1. The configuration step

- Enable IPv6 function.

```
SwitchA(config)#ipv6 enable
```

- Create the interface VLAN 11 and its address.

```
SwitchA(config)#vlan 11
SwitchA(config-vlan11)#switchport interface ethernet 1/0/11
SwitchA(config-vlan11)#exit
SwitchA(config)#interface vlan 11
SwitchA(config-if-vlan11)#ipv6 address 2000:3000:1000::1/64
```

- Configure the IPv6 static route to switch B from interface Vlan11.

```
SwitchA(config)#ipv6 route 2005:3000:1000::1/64 2000:3000:1000::2
```

- Configure tunnel interface: source, destination and type.

```
SwitchA(config)#interface tunnel 1
SwitchA(config-if-tunnel1)# tunnel source 2000:3000:1000::1
SwitchA(config-if-tunnel1)# tunnel destination 2005:3000:1000::1
SwitchA(config-if-tunnel1)# tunnel mode gre ipv6
SwitchA#show gre tunnel
name          mode          source          destination
Tunnel1       gre ipv6      2000:1000:3000::1  2005:1000:3000::1
The configuration of GRE tunnel is successful.
```

- Configure the IPv4 address of the tunnel interface. To run OSPF routing protocol, the interface address must be configured.

```
SwitchA (config-if-tunnel1)#ip address 100.1.1.1 255.255.255.0
```

- Configure the interface VLAN10 and its address.

```
SwitchA(config)#vlan 10
SwitchA(config-vlan10)#switchport interface ethernet 1/0/10
SwitchA(config-vlan10)#exit
SwitchA(config)#interface vlan 10
SwitchA(config-if-vlan10)# ip address 10.1.1.2 255.255.255.0
SwitchA(config-if-vlan10)#exit
```

- Configure loopback group and enable the tunnel to quote this loopback group.

```
SwitchA (config)#loopback-group 1
SwitchA (config-if-ethernet1/0/12)#loopback-group 1
```

```
SwitchA (config-if-tunnel1)# loopback-group 1
```

- Configure OSPF routing protocol.

```
SwitchA(config)#router ospf
SwitchA(config-router)#router-id 1.1.1.1
SwitchA(config-router)#network 100.1.1.0/24 area 0
SwitchA(config-router)#network 10.1.1.0/24 area 0
SwitchA(config-router)#exit
```

After the OSPF protocol of two ends are fully connected through the tunnel, we can see the tunnel route

```
SwitchA(config)#show ip route
O      20.1.1.0/24 [110/2] via 100.1.1.1, Tunnel1, 01:41:49 tag:0
```

(2) The configuration of device B

1. The configuration step

- Enable IPv6 function.

```
SwitchA(config)#ipv6 enable
```

- Create the interface VLAN 12 and its address.

```
SwitchA(config)#vlan 12
SwitchA(config-vlan12)#switchport interface ethernet 1/0/12
SwitchA(config-vlan12)#exit
SwitchA(config)#interface vlan 12
SwitchA(config-if-vlan12)#ipv6 address 2005:3000:1000::1/64
SwitchA(config-if-vlan12)#exit
SwitchA(config)#
```

- Configure the IPv6 static route to Switch A from interface Vlan12.

```
SwitchA(config)#ipv6 route 2000:3000:1000::1/64 2005:3000:1000::2
```

- Configure tunnel interface: source, destination and type.

```
SwitchA(config)#interface tunnel 1
SwitchA(config-if-tunnel1)# tunnel source 2005:3000:1000::1
SwitchA(config-if-tunnel1)# tunnel destination 2000:3000:1000::1
SwitchA(config-if-tunnel1)# tunnel mode gre ipv6
SwitchA#show gre tunnel
name      mode      source      destination
Tunnel1   gre ipv6   2005:1000:3000::1  2000:1000:3000::1
The configuration of GRE tunnel is successful.
```

- Configure the IPv4 address of the tunnel interface. To run OSPF routing protocol, the interface address must be configured.

```
SwitchA (config-if-tunnel1)#ip address 100.1.1.2 255.255.255.0
```

- Configure the interface VLAN20 and its address.

```
SwitchA(config)#vlan 20
SwitchA(config-vlan20)#switchport interface ethernet 1/0/10
SwitchA(config-vlan20)#exit
SwitchA(config)#interface vlan 20
SwitchA(config-if-vlan20)# ip address 20.1.1.2 255.255.255.0
SwitchA(config-if-vlan20)#exit
SwitchA(config)#
```

- Configure OSPF routing protocol.

```
SwitchA(config)#router ospf
SwitchA(config-router)#router-id 1.1.1.2
SwitchA(config-router)#network 100.1.1.0/24 area 0
SwitchA(config-router)#network 20.1.1.0/24 area 0
SwitchA(config-router)#exit
SwitchA(config)#
```

After the OSPF protocols of two ends are fully connected through the tunnel, we can see the tunnel route

```
SwitchB(config)#show ip route
O      10.1.1.0/24 [110/2] via 100.1.1.2, Tunnel1, 01:41:49 tag:0
```

### (3) The configuration of device C

#### 1. The configuration step

- Enable IPv6 function.

```
SwitchA(config)#ipv6 enable
```

- Create the interface VLAN 11 and its address.

```
SwitchA(config)#vlan 11
SwitchA(config-vlan11)#switchport interface ethernet 1/0/11
SwitchA(config-vlan11)#exit
SwitchA(config)#interface vlan 11
SwitchA(config-if-vlan11)#ipv6 address 2000:3000:1000::2/64
```

- Create the interface VLAN 12 and its address

```
SwitchA(config)#vlan 12
SwitchA(config-vlan12)#switchport interface ethernet 1/0/12
```

```
SwitchA(config-vlan12)#exit
SwitchA(config)#interface vlan 12
SwitchA(config-if-vlan12)#ipv6 address 2005:3000:1000::2/64
SwitchA(config-if-vlan12)#exit
```

(4) The configuration of PC

- Configure the IP address of PC1 and the default gateway.

PC1: the IP address: 10.1.1.1 255.255.255.0, the default gateway: 10.1.1.2

PC2: the IP address: 20.1.1.1 255.255.255.0, the default gateway: 20.1.1.2

## 43.5 GRE Tunnel Troubleshooting

If there is any problem happens when using GRE tunnel, please check whether the problem is caused by the following reasons:

- Check the configuration, whether the source and the destination addresses of the tunnel are correctly configured, whether the tunnel mode (tunnel mode gre {ip | ipv6}) is configured correctly.
- Check the static route that with the GRE tunnel interface as the next hop interface.
- Whether the connection is normal between the switches, use debug gre {packet | event | all} to check whether the switch receives and processes the GRE packets correctly.

---

# Chapter 44 ECMP Configuration

## 44.1 Introduction to ECMP

ECMP (Equal-cost Multi-path Routing) works in the network environment where there are many different links to arrive at the same destination address. If using the traditional routing technique, only a link can be used to send the data packets to the destination address, other links at the backup state or the invalidation state, and it needs some times to process the mutual switchover under the static routing environment. However, ECMP protocol can use multi-links under such network environment, it not only implements the load balance, increases the transport bandwidth, but also can completely backup the data transport of the invalidation links without delay and packet loss.

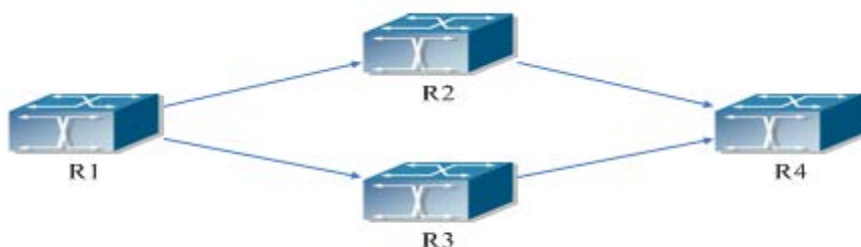

Figure 44-1 the application environment of ECMP

As it is shown in the figure, there are two paths can be selected from R1 to R4, they are R1-R2-R4 and R1-R3-R4. If the route type and the cost are same, then it can forms two routes from R1 to R4, but the next hop is different. If two routes are selected as the best, then they form the equal-cost route.

## 44.2 ECMP Configuration Task List

1. Configure the max number of equal-cost route
2. Configure load-balance mode for port-group

### 1. Configure the max number of equal-cost route

Command	Explanation
Global mode	
<b>maximum-paths &lt;1-8&gt;</b> <b>no maximum-paths</b>	Configure the max number of equal-cost route.

## 2. Configure load-balance mode for port-group

Command	Explanation
Global mode	
<code>load-balance {dst-src-mac   dst-src-ip   dst-src-mac-ip }</code>	Set load-balance for switch, it takes effect for port-group and ECMP function at the same time.

## 44.3 ECMP Typical Example

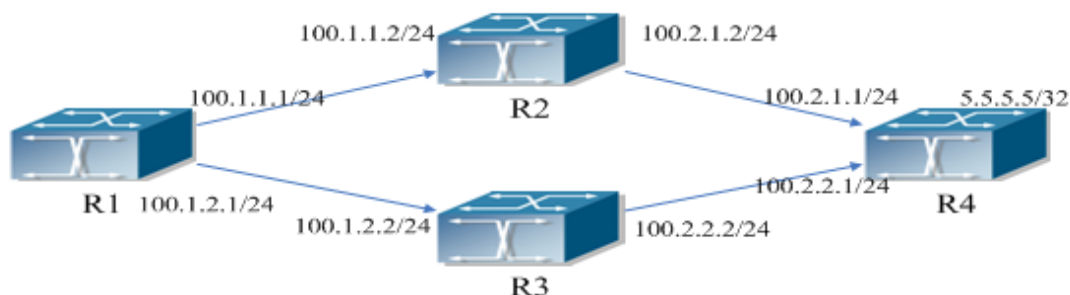

Figure 44-3 the application environment of ECMP

As it is shown in the figure, the R1 connect to R2 and R3 with the interface address 100.1.1.1/24 and 100.1.2.1/24. The R2 and R3 connect to R1 with the interface address 100.1.1.2/24 and 100.1.2.2/24. The R4 connect to R2 and R3 with interface address 100.2.1.1/24 and 100.2.2.1/24. The R2 and R3 connect to R4 with the interface address 100.2.1.2/24, 100.2.2.2/24. The loopback address of R4 is 5.5.5.5/32.

### 44.3.1 Static Route Implements ECMP

```
R1(config)#ip route 5.5.5.5/32 100.1.1.2
R1(config)#ip route 5.5.5.5/32 100.1.2.2
```

On R1, show ip route, the following is displayed:

```
R1(config)#show ip route
```

Codes: K - kernel, C - connected, S - static, R - RIP, B - BGP

O - OSPF, IA - OSPF inter area

N1 - OSPF NSSA external type 1, N2 - OSPF NSSA external type 2

E1 - OSPF external type 1, E2 - OSPF external type 2

i - IS-IS, L1 - IS-IS level-1, L2 - IS-IS level-2, ia - IS-IS inter area

\* - candidate default

```
C    1.1.1.1/32 is directly connected, Loopback1 tag:0
S    5.5.5.5/32 [1/0] via 100.1.1.2, Vlan100  tag:0
      [1/0] via 100.1.2.2, Vlan200  tag:0
C    100.1.1.0/24 is directly connected, Vlan100 tag:0
C    100.1.2.0/24 is directly connected, Vlan200 tag:0
C    127.0.0.0/8 is directly connected, Loopback tag:0
Total routes are : 6 item(s)
```

## 44.3.2 OSPF Implements ECMP

### R1 configuration:

```
R1(config)#interface Vlan100
R1(Config-if-Vlan100)# ip address 100.1.1.1 255.255.255.0
R1(config)#interface Vlan200
R1(Config-if-Vlan200)# ip address 100.1.2.1 255.255.255.0
R1(config)#interface loopback 1
R1(Config-if-loopback1)# ip address 1.1.1.1 255.255.255.255
R1(config)#router ospf 1
R1(config-router)# ospf router-id 1.1.1.1
R1(config-router)# network 100.1.1.0/24 area 0
R1(config-router)# network 100.1.2.0/24 area 0
```

### R2 configuration:

```
R2(config)#interface Vlan100
R2(Config-if-Vlan100)# ip address 100.1.1.2 255.255.255.0
R2(config)#interface Vlan200
R2(Config-if-Vlan200)# ip address 100.2.1.2 255.255.255.0
R2(config)#interface loopback 1
R2(Config-if-loopback1)# ip address 2.2.2.2 255.255.255.255
R2(config)#router ospf 1
R2(config-router)# ospf router-id 2.2.2.2
R2(config-router)# network 100.1.1.0/24 area 0
R2(config-router)# network 100.2.1.0/24 area 0
```

### R3 configuration:

```
R3(config)#interface Vlan100
R3(Config-if-Vlan100)# ip address 100.1.2.2 255.255.255.0
R3(config)#interface Vlan200
R3(Config-if-Vlan200)# ip address 100.2.2.2 255.255.255.0
R3(config)#interface loopback 1
R3(Config-if-loopback1)# ip address 3.3.3.3 255.255.255.255
R3(config)#router ospf 1
```



```
R3(config-router)# ospf router-id 3.3.3.3
R3(config-router)# network 100.1.2.0/24 area 0
R3(config-router)# network 100.2.2.0/24 area 0
```

#### R4 configuration:

```
R4(config)#interface Vlan100
R4(Config-if-Vlan100)# ip address 100.2.1.1 255.255.255.0
R4(config)#interface Vlan200
R4(Config-if-Vlan200)# ip address 100.2.2.1 255.255.255.0
R4(config)#interface loopback 1
R4(Config-if-loopback1)# ip address 5.5.5.5 255.255.255.255
R4(config)#router ospf 1
R4(config-router)# ospf router-id 4.4.4.4
R4(config-router)# network 100.2.1.0/24 area 0
R4(config-router)# network 100.2.2.0/24 area 0
```

On R1, show ip route, the following is displayed:

```
R1(config)#show ip route

Codes: K - kernel, C - connected, S - static, R - RIP, B - BGP
       O - OSPF, IA - OSPF inter area
       N1 - OSPF NSSA external type 1, N2 - OSPF NSSA external type 2
       E1 - OSPF external type 1, E2 - OSPF external type 2
       i - IS-IS, L1 - IS-IS level-1, L2 - IS-IS level-2, ia - IS-IS inter area
       * - candidate default

C       1.1.1.1/32 is directly connected, Loopback1 tag:0
O       5.5.5.5/32 [110/3] via 100.1.1.2, Vlan100, 00:00:05 tag:0
         [110/3] via 100.1.2.2, Vlan200, 00:00:05 tag:0
C       100.1.1.0/24 is directly connected, Vlan100 tag:0
C       100.1.2.0/24 is directly connected, Vlan200 tag:0
O       100.2.1.0/24 [110/2] via 100.1.1.2, Vlan100, 00:02:25 tag:0
O       100.2.2.0/24 [110/2] via 100.1.2.2, Vlan200, 00:02:25 tag:0
C       127.0.0.0/8 is directly connected, Loopback tag:0

Total routes are : 8 item(s)
```

## 44.4 ECMP Troubleshooting

When configuring ECMP, ECMP may not run normally for the reasons of physical connection and false configuration, so users should note the following essential.

- When using ECMP, load-balance mode should be set as `dst-src-ip` or `dst-src-mac-ip`, after that, load-balance is correct for packets.

---

# Chapter 45 BFD

## 45.1 Introduction to BFD

BFD (Bidirectional Forwarding Detection) provides a detection mechanism to quickly detect and monitor the connectivity of links in networks. To improve network performance, between protocol neighbors must quickly detect communication failures to restore communication through backup paths as soon as possible.

BFD provides a general-purpose, standard, medium-independent and protocol-independent fast failure detection mechanism. It can uniformly and quickly detect the failures of the bidirectional forwarding paths between two network devices for super stratum protocols, such as routing protocols and Multiprotocol Label Switching (MPLS). BFD establishes session between two network devices to monitor their bidirectional forwarding paths to serve for super stratum protocols. However, there is no discovery mechanism for BFD, it is notified by super stratum protocol to establish sessions. After a session is established, if no BFD control packet is received from the peer within detection time, it notifies the failure to super stratum protocol which will take appropriate measures.

## 45.2 BFD Configuration Task List

1. Configure BFD basic function
2. Configure BFD for RIP (ng)
3. Configure BFD for static route (IPv6)
4. Configure BFD for VRRP (v3)

1. Configure BFD basic function

Command	Explanation
Global mode	
<b>bfd mode{active   passive}</b> <b>no bfd mode</b>	Configure the mode before establishing BFD session, the default is active mode. No command restores active mode.
<b>bfd authentication key &lt;1-255&gt; text</b> <b>&lt;WORD&gt;</b> <b>no bfd authentication key &lt;1-255&gt;</b>	Configure key and authentication character string encrypted with text for BFD, no command deletes the configured key.
<b>bfd authentication key &lt;1-255&gt; md5</b> <b>&lt;WORD&gt;</b> <b>no bfd authentication key</b>	Configure key and authentication character string encrypted with md5 for BFD, no command deletes the configured key.
Interface Mode	

<b>bfd interval &lt;value1&gt; min_rx &lt;value2&gt; multiplier &lt;value3&gt;</b> <b>no bfd interval</b>	Configure the minimum transmission interval and the multiplier of session detection for BFD control packets, no command restores the default detection multiplier.
<b>bfd min-echo-receive-interval &lt;value&gt;</b> <b>no bfd min-echo-receive-interval</b>	Configure the minimum receiving interval for BFD control packets, no command restores its default value.
<b>bfd echo</b> <b>no bfd echo</b>	Enable bfd echo, no command disables the function.
<b>bfd echo-source-ip &lt;ipv4-address&gt;</b> <b>no bfd echo-source-ip</b>	Detect link fault by configuring source address of echo packets, no command deletes the configured source address of echo packets.
<b>bfd echo-source-ipv6 &lt;ipv6-address&gt;</b> <b>no bfd echo-source-ipv6</b>	Detect link fault by configuring source address of echo packets, no command deletes the configured source address of echo packets.
<b>bfd authentication key &lt;1-255&gt;</b> <b>no bfd authentication key</b>	Enable BFD authentication and configure key for interface, no command disables BFD authentication.

## 2. Configure BFD for RIP (ng)

Command	Explanation
Interface Mode	
<b>rip bfd enable</b> <b>no rip bfd enable</b>	Configure BFD for RIP protocol on the specific interface, no command disables BFD for RIP protocol.
<b>ipv6 rip bfd enable</b> <b>no ipv6 rip bfd enable</b>	Configure BFD for RIPng protocol on the specific interface, no command cancels the configuration.

## 3. Configure BFD for static route (IPv6)

Command	Explanation
Global Mode	
<b>ip route {vrf &lt;name&gt; &lt;ipv4-address&gt;   &lt;ipv4-address&gt;} mask &lt;nexthop&gt; bfd</b> <b>no ip route {vrf &lt;name&gt; &lt;ipv4-address&gt;   &lt;ipv4-address&gt;} mask &lt;nexthop&gt; bfd</b>	Configure BFD for the static route, no command cancels the configuration.

<pre> <b>ipv6 route {vrf &lt;name&gt; &lt;ipv6-address&gt;   &lt;ipv6-address&gt;} prefix &lt;nexthop&gt; bfd no ipv6 route {vrf &lt;name&gt; &lt;ipv6-address&gt;   &lt;ipv6-address&gt;} prefix &lt;nexthop&gt; bfd</b> </pre>	<p>Configure BFD for the static IPv6 route, no command cancels the configuration.</p>
--	---

#### 4. Configure BFD for VRRP (v3)

Command	Explanation
VRRP(v3) Group Configuration Mode	
<b>bfd enable</b> <b>no bfd enable</b>	Enable BFD for VRRP(v3) protocol and enable BFD detection on this group, no command disables the function.

## 45.3 Examples of BFD

### 45.3.1 Example for Linkage of BFD and Static Route

Example:

Configure a static route to 14.1.1.0/24 on Switch A and configure a static route to 13.1.1.0/24 on Switch B. Both switches enable BFD detection. When the link between Switch A and Switch B is failing, BFD can detect it immediately.



Configuration procedure:

Switch A:

```

Switch#config
Switch(config)#interface vlan 12
Switch(config-if-vlan12)#ip address 12.1.1.1 255.255.255.0
Switch(config)#interface vlan 15
Switch(config-if-vlan15)#ip address 15.1.1.1 255.255.255.0
Switch(config)#ip route 14.1.1.0 255.255.255.0 12.1.1.2 bfd

```

Switch B:

```

Switch#config
Switch(config)#interface vlan 12
Switch(config-if-vlan12)#ip address 12.1.1.2 255.255.255.0

```

```
Switch(config)#interface vlan 14
Switch(config-if-vlan15)#ip address 14.1.1.1 255.255.255.0
Switch(config)#ip route 15.1.1.0 255.255.255.0 12.1.1.1 bfd
```

When the link between Switch B and layer 2 switch is failing, Switch A can detect the change of Switch B immediately, here the static routing is at inactive state.

### 45.3.2 Example for Linkage of BFD and RIP Route

Example:

Switch A and Switch B are connected and run RIP protocol, both of them enable BFD function. When the link between Switch A and Switch B is failing, BFD can detect it immediately.

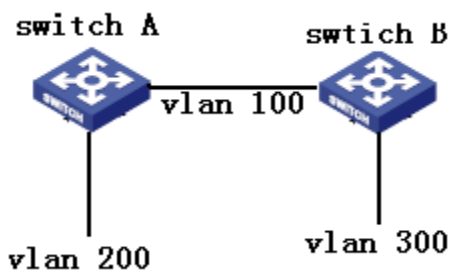

Configuration procedure:

Switch A:

```
Switch#config
Switch(config)#bfd mode active
Switch(config)#interface vlan 100
Switch(config-if-vlan100)#ip address 10.1.1.1 255.255.255.0
Switch(config)#interface vlan 200
Switch(config-if-vlan200)#ip address 20.1.1.1 255.255.255.0
Switch(config)#router rip
Switch (config-router)#network vlan 100
Switch (config-router)#network vlan 200
Switch(config)#interface vlan 100
Switch(config-if-vlan100) #rip bfd enable
```

Switch B:

```
Switch#config
Switch(config)#bfd mode passive
Switch(config)#interface vlan 100
Switch(config-if-vlan100)#ip address 10.1.1.2 255.255.255.0
Switch(config)#interface vlan 300
Switch(config-if-vlan300)#ip address 30.1.1.1 255.255.255.0
Switch(config)#router rip
Switch (config-router)#network vlan 100
```

```

Switch (config-router)#network vlan 300
Switch(config)#interface vlan 100
Switch(config-if-vlan100) #rip bfd enable

```

When the link between Switch A and Switch B is failing, BFD can detect it immediately and notifies RIP to delete the learnt route.

### 45.3.3 Example for Linkage of BFD and VRRP

Example:

When the master is failing, the backup cannot become the master until the configured timeout timer expires. The timeout is generally three to four seconds and therefore the switchover is slow. To solve this problem, VRRP uses BFD to probe the state of the master. Once the master fails, the backup can become the new master within 100 ms.

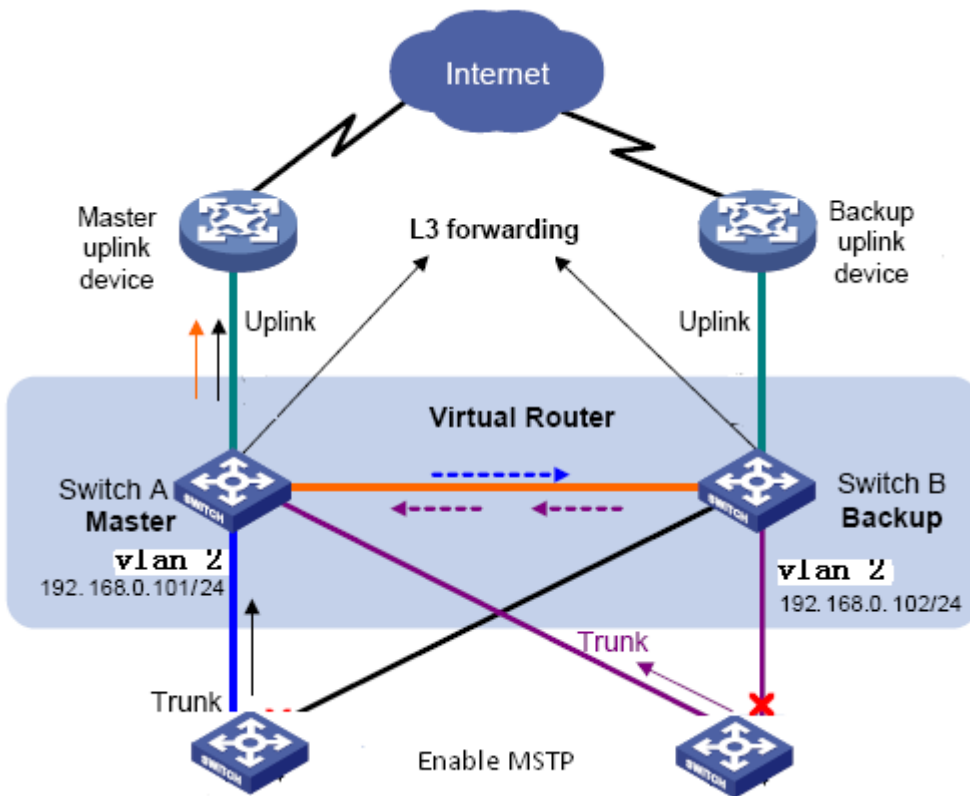

Configuration procedure:

# Configure Switch A

```

Switch#config
Switch(config)#bfd mode active
Switch(config)#interface vlan 2
Switch(config-if-vlan2)#ip address 192.16.0.101 255.255.255.0
Switch(config)#router vrrp 1
Switch(config-router)#virtual-ip 192.168.0.10
Switch(config-router)#interface vlan 1

```

```
Switch(config-router)#enable
Switch(config-router)#bfd enable
```

#### # Configure Switch B

```
Switch#config
Switch(config)#bfd mode passive
Switch(config)#interface vlan 2
Switch(config-ip-vlan2)#ip address 192.16.0.102 255.255.255.0
Switch(config)#router vrrp 1
Switch(config-router)#virtual-ip 192.168.0.10
Switch(config-router)#interface vlan 1
Switch(config-router)#enable
Switch(config-router)#bfd enable
```

## 45.4 BFD Troubleshooting

When the problem of BFD function happens, please check whether the problem is resulted by the following reasons:

- Check whether the route protocol neighbor is established successfully. If no route protocol neighbor is established successfully, here BFD can not process the detection.
- Check whether the configured source-ip is correct for linkage with static route, if the connectivity of IP between two peers fails, BFD can not process the detection.
- Check whether VRRP group is established successfully for linkage with VRRP protocol. If no VRRP group is established successfully, here BFD can not process the detection.

---

# Chapter 46 BGP GR

## 46.1 Introduction to GR

Along with network development, it requires the higher availability, so HA (High Availability) is set, namely, how to ensure packets to be forwarded and does not affect traffic operation when router control layer can not work normally.

Usually, when a router does not work normally, neighbor in route protocol layer will detect their relationship to be down, and is up soon. The process is called neighborhood shock. This shock will result the router shock that will eventually result router black hole or data passed by restarted router. Finally network availability will decrease quickly.

In order to achieve high availability, it needs upper layer route protocol to support GR (Graceful Restart). Use GR can ensure that packets can be processed or forwarded correctly when the control layer is failing.

GR can reduce route shock, resource expend consumption of control layer and improve network stability. What describe in this document is GR, which can restart BGP protocol without affecting forwarding process, and forward packets in the correct path.

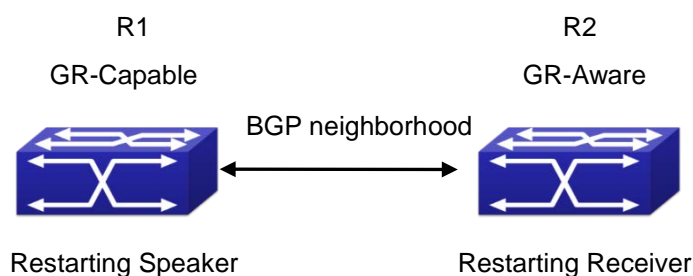

**Figure 46-1** Application environment for GR

GR needs cooperation of GR-Capable router and GR-Aware router to complete. A restarted router is call Restarting Speaker ( or GR-Restarter ) , and its neighbor can be called Receiving Speaker ( or GR-Helper ) . Restarting Speaker is GR-Capable router while Receiving Speaker is GR-Aware router. In this way, they can complete GR. Suppose that router R1 and R2 establish BGP neighborhood, as shown in Figure 46-1, GR process can be described as:

Restarting Speaker ( GR-Restarter ) :

1. R1 and R2 negotiate GR capability through OPEN when establish original BGP neighbor.
2. When R1 is restarted, the route is kept in the interface board and guide forwarding continuously.
3. R1 establishes TCP connection with R2 again, it sets Restart state to 1 in BGP OPEN messages to show that this router has been restarted. At the same time, it will inform the value of restart time (it is less than Holdtime in OPEN messages) to neighbor. Additionally, it should inform neighbor what type of GR is supported.
4. After R1 is established connection with R2 correctly, it is able to receive and deal with the update



---

information and enable selection deferral timer.

5. R1 delays the count process of the local BGP route until it receives all End-of-RIB from BGP neighbors in GR-Aware or until the local selection deferral timer is overtime.
6. Count route and send the update route. After that, it will send End-of-RIB to neighbors.

Restarting Speaker ( GR-Helper ) :

1. R1 and R2 negotiate GR capability with the restarted router when they establish the original neighborhood with BGP, R1 is a router that support GR-Capable.
2. When R1 is restarted, R2 may senses that TCP between R1 and R2 is cut off or cannot detect the previous state before they establish TCP connection again. If it does not detect it, go to step 4, otherwise go to step 3.
3. Keep the route sent by R1 and mark a stale label. After that, enable Restart Timer.
4. Cut off old TCP connection and deal with new TCP connection continuously. Keep the route sent by R1 and mark a stale label. After that, enable Restart Timer.
5. Establish a new neighborhood with the restarted router, delete Restart Timer and enable Stale Path Timer.
6. Before establish the new neighborhood, If Restart Timer is overtime, Restart flag does not equal 1, or there is no relevant supporting information in AFI/SAFI address family, please clear the kept route.
7. Send the route update information to the restarted router, after that, it will send End-Of-RIB label.
8. If Stale Path Timer is overtime, clear the kept route.

## 46.2 GR Configuration Task List

1. Configure whether GR capability is supported
2. Configure whether the specific neighbor supports GR capability
3. Configure restart-time
4. Configure restart-time for neighbor
5. Configure stale-path-time for BGP GR
6. Configure selection-deferral-time for BGP GR

1. Configure whether GR capability is supported

Command	Explanation
BGP route configuration mode	
<b>bgp graceful-restart</b> <b>no bgp graceful-restart</b>	Enable BGP to support GR.

2. Configure whether the specific neighbor supports GR capability

Command	Explanation
BGP protocol unicast address family mode and VRF address family mode	
<b>neighbor (A.B.C.D   X:X::X:X   WORD) capability graceful-restart</b> <b>no neighbor (A.B.C.D   X:X::X:X   WORD) capability graceful-restart</b>	Set a label for neighbor, it takes GR parameter when send OPEN messages.

3. Configure restart-time

Command	Explanation
BGP route configuration mode	
<b>bgp graceful-restart restart-time &lt;1-3600&gt;</b> <b>no bgp graceful-restart restart-time &lt;1-3600&gt;</b>	Configure BGP GR's restart-time (Receiving Speaker enables a timeout timer for a neighbor, it uses the restart-time as the timeout). A restart-time specifies the longest waiting time from Receiving Speaker finds restarting to the received OPEN messages. If Receiving Speaker does not receive OPEN messages after exceed the time, it can delete SATLE route saved by neighbor.

4. Configure restart-time for neighbor

Command	Explanation
BGP protocol unicast address family mode and VRF address family mode	
<b>neighbor (A.B.C.D   X:X::X:X   WORD) restart-time &lt;1-3600&gt;</b> <b>no neighbor (A.B.C.D   X:X::X:X   WORD) restart-time &lt;1-3600&gt;</b>	Configure restart-time for neighbors, no command restores the default time.

5. Configure stale-path-time for BGP GR

Command	Explanation
BGP route configuration mode	

<b>bgp graceful-restart stale-path-time</b> <b>&lt;1-3600&gt;</b> <b>no bgp graceful-restart</b> <b>stale-path-time &lt;1-3600&gt;</b>	Stale path-time uses the default value of 360s, which is much longer than restart-time and selection-deferral-time. Because during the time from Receiving Speaker receives OPEN messages to receives EOR, it sends the initial route update and waits that the initial route update is received completely.
---	--

#### 6. Configure selection-deferral-time for BGP GR

Command	Explanation
BGP route configuration mode	
<b>bgp selection-deferral-time</b> <b>&lt;1-3600&gt;</b> <b>no bgp selection-deferral-time</b> <b>&lt;1-3600&gt;</b>	Specify the longest waiting time that start to count selection route from the received OPEN messages to the received EOR for Restarting Speaker. If Restarting Speaker does not receive EOR after exceed the time, it can count selection route.

## 46.3 Typical Example of GR

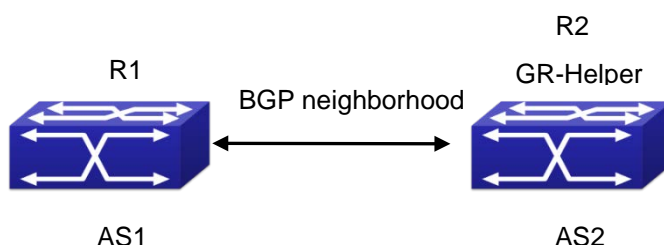

**Figure 46-2** Application environment for GR

As shown in Figure 46-2, R1 and R2 establish BGP neighborhood. When they cut off the connection, BGP protocol in R2 will be in helper mode, keep route entry from R1 to R2 and restart restart-time timer. During that time, if it receives open messages from R1 or timer is overtime, the route marked with stale in R2 will be deleted. When they establish neighborhood again, R1 will enable selection timer and wait R2 to send EOR messages or until timer is overtime, R1 is a selection route. However, after R2 receives open messages from R1, it enables STALE route timer and it will delete timer and stale route when accept EOR from R1 or timer is overtime.

R1 configures int vlan 12 , ip address 12.1.1.1

---

R2 configures int vlan 12 , ip address 12.1.1.2

R1 configuration:

```
R1#config
R1(config)#vlan 12
R1(config-vlan12)#int vlan 12
R1(config-if-vlan12)#ip address 12.1.1.1 255.255.255.0
R1(config-if-vlan12)#exit
R1(config)#router bgp 1
R1(config-router)#neighbor 12.1.1.2 remote-as 2
R1(config-router)#neighbor 12.1.1.2 capability graceful-restart
R1(config-router)#bgp selection-deferral-time 120
R1(config-router)#bgp graceful-restart restart-time 60
R1(config-router)#bgp graceful-restart stale-path-time 180
R1(config-router)#exit
```

R2 configuration:

```
R2#config
R2(config)#vlan 12
R2(config-vlan12)#int vlan 12
R2(config-if-vlan12)#ip address 12.1.1.2 255.255.255.0
R2(config-if-vlan12)#exit
R2(config)#router bgp 2
R2(config-router)#neighbor 12.1.1.1 remote-as 1
R2(config-router)#neighbor 12.1.1.1 capability graceful-restart
R2(config-router)#bgp selection-deferral-time 120
R2(config-router)#bgp graceful-restart restart-time 60
R2(config-router)#bgp graceful-restart stale-path-time 180
R2(config-router)#exit
```

---

# Chapter 47 OSPF GR

## 47.1 Introduction to OSPF GR

OSPF Graceful-Restart (short for OSPF GR) is used to maintain data forwarding correctly and flow of crucial service is not interrupted when routing protocol restarts or switchover of layer 3 switches between active master and standby master. It is one of high availability technologies.

So far, the high layer 3 switches usually adopt a design for separating control and forwarding. The control module for counting routing protocol at master control board, but data forwarding module is at liner card. As a result, it will not affect data forwarding on line card when the master control board is restarted. So the device supporting GR is generally a chassis device and has two master control boards.

Since standard OSPF protocol (RFC2328) does not support GR, it will lead to flow cut off and routing surge when routing protocol is restarted or switchover between active master and standby master for various reasons. For example, as shown in below figure, when S1 occurs switchover, the neighborhood relation between S1 and S2 will lose, at that time S2 will send Router-LSA to S3 and S4 and this LSA does not include the link between S1 and S2. After S3 and S4 received LSA, they will count routing protocol again. The result will not include the link between S1 and S2. After S1 finishes the switchover, it will establish neighborhood relation with S2 and synchronize database, this action leads S2, S3 and S4 to count routing again. However, switchover of S1 will result routing shiver, which is not accepted by some networks with high requirement for performance.

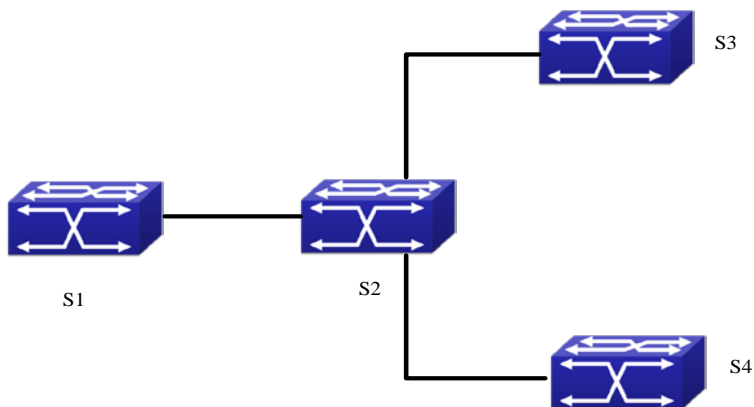

**Figure 47-1** typical application scene

OSPF GR described in RF C3623 is come up for the above state. Its basic idea is that if the network topology keeps stabilization during the switchover and layer 3 switch can maintain the same forwarding list, then its neighbor can maintain their relationship, which can make the switch on its forwarding path still. If S1 and S2 support and enable GR, the liner card of S1 will keep the traffic forwarding and S2 can maintain the relationship with S1, at the same time, network topology between S3 and S4 will not be changed, furthermore, it does not need to count routing again. All of these ensure the traffic forwarding and avoid routing shiver.

Layer 3 switch can be divided into GR restarter and GR helper according to its function in GR process. GR restarter is layer 3 switch to occur the switchover between active master and standby master or restart

---

protocol while GR helper is layer 3 switch to help GR restarter. In the above example, S1 is GR restarter and S2 is GR helper

The advantages of OSPF GR in the following:

- Increase network reliability
- Reduce the effect of routing shiver to network
- Reduce the effect to traffic and avoid that lose packets during switchover

## 47.2 OSPF GR Configuration

OSPF GR configuration task list:

1. Enable GR for OSPF
2. Configure grace-period for OSPF GR restarter (optional)
3. Configure policy for OSPF GR helper (optional)

### 1. Enable GR for OSPF

Command	Explanation
OSPF protocol configuration mode	
<b>capability restart graceful</b> <b>no capability restart</b>	Enable GR of specific OSPF.

### 2. Configure grace-period for OSPF GR restarter (optional)

Command	Explanation
Global configuration mode	
<b>ospf graceful-restart grace-period</b> <b>&lt;integer&gt;</b> <b>no ospf restart grace-period</b>	Configure grace period for GR restarter (The switch is used to the switchover or restart the protocol). The no command restores its default value.

### 3. Configure the policy for OSPF GR helper (optional)

Command	Explanation
Global configuration mode	
<b>ospf graceful-restart helper</b> <b>max-grace-period &lt;integer&gt;</b> <b>no ospf graceful-restart helper</b>	One of GR helper policy. Configure maximum grace period supported by helper. The no command deletes all configured helper policy.
<b>ospf graceful-restart helper never</b> <b>no ospf graceful-restart helper</b>	One of GR helper policy. Configure the switch can not become OSPF GR helper. The no command deletes all configured helper policy.

---

## 47.3 OSPF GR Example

Example:

There are four switches from S1 to S4 (They are two master control board and supports OSPF GR), they enable OSPF to implement the following functions:

1. S1 keeps traffic forwarding during the switchover, S2-S4 ensure that no routing shiver and the continuous network traffic.
2. S1 needs to finish the switchover and restart protocol within 120s, otherwise S2 will quit GR and count routing again.
3. S1 does not work as a OSPF GR Helper (S1 will not help S2 to process GR, but it will count routing again when S2 processes the switchover or restart OSPF protocol).

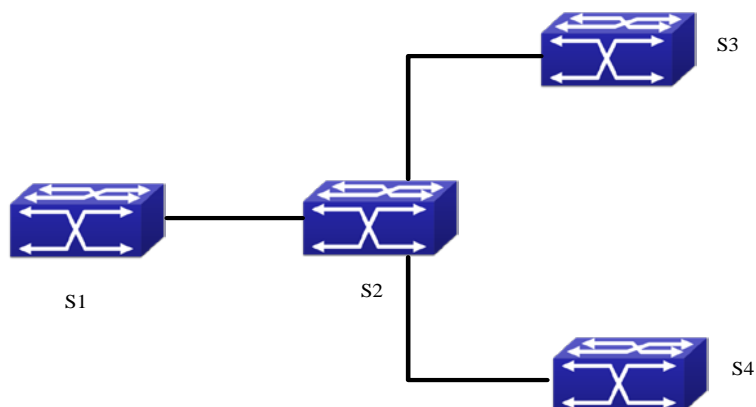

**Figure 47-2** Typical application

Steps: Since the switch enables OSPF GR by default, we only need to configure the parameters and helper policy for OSPF GR. (the following configuration is relative with OSPF GR only and that of topology is omitted).

S1

```
S1(config)#ospf graceful-restart grace-period 120
S1(config)# ospf graceful-restart helper never
```

S2

```
S2(config)# ospf graceful-restart helper max-grace-period 120
```

---

## 47.4 OSPF GR Troubleshooting

When you have trouble in using OSPF GR, please check the following reasons:

- Whether GR restarter switch supports OSPF GR and has two main control boards, please ensure that specific GR is not disabled.
- Whether network topology is changed during OSPF GR process. When it is changed, switch may quit GR and restart OSPF.
- Please ensure all neighbors of GR restarter support GR.
- Do not modify the relevant configuration of OSPF during GR.



---

# Chapter 48 IPv4 Multicast Protocol

## 48.1 IPv4 Multicast Protocol Overview

This chapter will give an introduction to the configuration of IPv4 Multicast Protocol. All IPs in this chapter are IPv4.

### 48.1.1 Introduction to Multicast

Various transmission modes can be adopted when the destination of packet (including data, sound and video) transmission is the minority users in the network. One way is to use Unicast mode, i.e. to set up a separate data transmission path for each user; or, to use Broadcast mode, which is to send messages to all users in the network, and they will receive the Broadcast messages no matter they need or not. For example, if there are 200 users in a network who want to receive the same packet, then the traditional solution is to send this packet for 200 times separately via Unicast to guarantee the users who need the data can get all data wanted, or send the data in the entire domain via Broadcast. Transferring the data in the whole range of network. The users who need these data can get directly from the network. Both modes waste a great deal of valuable bandwidth resource, and furthermore, Broadcast mode goes against the security and secrecy.

The emergence of IP Multicast technology solved this problem in time. The Multicast source only sends out the message once, Multicast Routing Protocol sets up tree-routing for Multicast data packet, and then the transferred packet just starts to be duplicated and distributed in the bifurcate crossing as far as possible. Thus the packet can be sent to every user who needs it accurately and effectively.

It should be noticed that it is not necessary for Multicast source to join in Multicast group. It sends data to some Multicast groups, but it is not necessarily a receiver of the group itself. There can be more than one source sending packets to a Multicast group simultaneously. There may exist routers in the network which do not support Multicast, but a Multicast router can encapsulate the Multicast packets into Unicast IP packets with tunnel mode to send them to the Multicast router next to it, which will take off the Unicast IP header and continue the Multicast transmission process, thus a big alteration of network structure is avoided. The primary advantages of Multicast are:

1. Enhance efficiency: reduce network traffic, lighten the load of server and CPU
2. Optimize performance: reduce redundant traffic
3. Distributed application: Enable Multipoint Application

### 48.1.2 Multicast Address

The destination address of Multicast message uses class D IP address with range from 224.0.0.0 to 239.255.255.255. D class address can not appear in the source IP address field of an IP message. In the process of Unicast data transmission, the transmission path of a data packet is from source address routing to destination address, and the transmission is performed with hop-by-hop principle. However, in IP Multicast environment, the destination addresses is a group instead of a single one, they form a group address. All message receivers will join in a group, and once they do, the data flowing to the group address will be sent to the receivers immediately and all members in the group will receive the data packets. The members in a

---

Multicast group are dynamic, the hosts can join and leave the Multicast group at any time.

Multicast group can be permanent or temporary. Some of the Multicast group addresses are assigned officially; they are called Permanent Multicast Group. Permanent Multicast Group keeps its IP address fixed but its member structure can vary within. The member amount of Permanent Multicast Group can be arbitrary, even zero. The IP Multicast addresses which are not kept for use by Permanent Multicast Group can be utilized by temporary Multicast groups.

224.0.0.0~224.0.0.255 are reserved Multicast addresses (Permanent Group Address), address 224.0.0.0 is reserved but not assigned, and other addresses are used by Routing Protocol; 224.0.1.0~238.255.255.255 are Multicast addresses available to users (Temporary Group Address) and are valid in the entire domain of the network; 239.0.0.0~239.255.255.255 are local management Multicast addresses, which are valid only in specific local domain. Frequently used reserved multicast address list is as follows:

- Benchmark address (reserved)
- 224.0.0.1 Address of all hosts
- 224.0.0.2 Address of all Multicast Routers
- 224.0.0.3 Unassigned
- 224.0.0.4 DVMRP Router
- 224.0.0.5 OSPF Router
- 224.0.0.6 OSPF DR
- 224.0.0.7 ST Router
- 224.0.0.8 ST host
- 224.0.0.9 RIP-2 Router
- 224.0.0.10 IGRP Router
- 224.0.0.11 Active Agent
- 224.0.0.12 DHCP Server/Relay Agent
- 224.0.0.13 All PIM Routers
- 224.0.0.14 RSVP Encapsulation
- 224.0.0.15 All CBT Routers
- 224.0.0.16 Specified SBM
- 224.0.0.17 All SBMS
- 224.0.0.18 VRRP
- 224.0.0.22 IGMP

When Ethernet transmits Unicast IP messages, the destination MAC address it uses is the receiver's MAC address. But in transmitting Multicast packets, the transmission destination is not a specific receiver any more, but a group with uncertain members, thus Multicast MAC address is used. Multicast MAC address is corresponding to Multicast IP address. It is prescribed in IANA (Internet Assigned Number Authority) that the higher 25 bits in Multicast MAC address is 0x01005e, and the lower 23bits in MAC address is the lower 23bits in Multicast IP address.

Since only 23bits out of the lower 28bits in IP Multicast address are mapped into MAC address, therefore there are 32 IP Multicast addresses which are mapped into the same MAC address.

---

### 48.1.3 IP Multicast Packet Transmission

In Multicast mode, the source host sends packets to the host group indicated by the Multicast group address in the destination address field of IP data packet. Unlike Unicast mode, Multicast data packet must be forwarded to a number of external interfaces to be sent to all receiver sites in Multicast mode, thus Multicast transmission procedure is more complicated than Unicast transmission procedure.

In order to guarantee that all Multicast packets get to the router via the shortest path, the receipt interface of the Multicast packet must be checked in some certain way based on Unicast router table; this checking mechanism is the basis for most Multicast Routing Protocol to forward in Multicast mode --- RPF (Reverse Path Forwarding) check. Multicast router makes use of the impressed packet source address to query Unicast Router Table or independent Multicast Router Table to determine if the packet ingress interface is on the shortest path from receipt site to source address. If shortest path Tree is used, then the source address is the address of source host which sends Multicast Data Packets; if Shared Tree is used, then the source address is the address of the root of the Shared-Tree. When Multicast data packet gets to the router, if RPF check passes, then the data packet is forwarded according to Multicast forward item, and the data packet will be discarded else wise.

### 48.1.4 IP Multicast Application

IP Multicast technology has effectively solved the problem of sending in single point and receiving in multipoint. It has achieved the effective data transmission from a point to multiple points, saved a great deal of network bandwidth and reduced network load. Making use of the Multicast property of network, some new value-added operations can be supplied conveniently. In Information Service areas such as online living broadcast, network TV, remote education, remote medicine, real time video/audio meeting, the following applications may be supplied:

- 1) Application of Multimedia and Streaming Media
- 2) Data repository, finance application (stock) etc
- 3) Any data distribution application of "one point to multiple points"

In the situation of more and more multimedia operations in IP network, Multicast has tremendous market potential and Multicast operation will be generalized and popularized.

## 48.2 PIM-DM

### 48.2.1 Introduction to PIM-DM

PIM-DM (Protocol Independent Multicast, Dense Mode) is a Multicast Routing Protocol in dense mode which applies to small network. The members of multicast group are relatively dense under this kind of network environment.

---

The working process of PIM-DM can be summarized as: Neighbor Discovery, Flooding & Prune, and Graft.

### **1. Neighbor Discovery**

After PIM-DM router is enabled, Hello message is required to discover neighbors. The network nodes which run PIM-DM use Hello message to contact each other. PIM-DM Hello message is sent periodically.

### **2. Flooding & Prune of process**

PIM-DM assumes all hosts on the network are ready to receive Multicast data. When some Multicast Source begins to send data to a Multicast Group G, after receiving the Multicast packet, the router will make RPF check first according to the Unicast table. If the check passes, the router will create a (S, G) table entry and transmit the Multicast packet to all downstream PIM-DM nodes on the network (Flooding). If the RPF check fails, i.e. the Multicast packet is input from the incorrect interface, and then the message is discarded. After this procedure, in the PIM-DM Multicast domain, every node will create a (S, G) table entry. If there is no Multicast group member in the downstream nodes, then a Prune message is sent to upstream nodes to notify them not to transmit data of this Multicast group any more. After receiving Prune message, the upstream nodes will delete the corresponding interface from the output interface list to which their Multicast transmission table entry (S, G) corresponds. Thus a SPT ( Shortest Path Tree, SPT ) tree with source S as root is created. The Prune process is initiated by leaf router first.

The process above is called Flooding & Prune process. Each pruned node also provides time-out mechanics at the same time. When Prune is timed-out, the router will restart Flooding & Prune process. The PIM-DM Flooding & Prune is periodically processed.

### **3. RPF Check**

With RPF Check, PIM-DM makes use of existing Unicast routing table to establish a Multicast transmission tree initiating from data source. When a Multicast packet arrives, the router will determine whether the coming path is correct first. If the arrival interface is the interface connected to Multicast source indicated by Unicast routing, then this Multicast packet is considered to be from the correct path. Otherwise the Multicast packet is to be discarded as redundant message. The Unicast routing message used as path judgment can root in any Unicast Routing Protocol, such as messages found by RIP, OSPF, etc. It doesn't rely on any specific Unicast Routing Protocol.

### **4. Assert Mechanism**

If each of two Multicast routers A and B on the same LAN segment has a receiving route respectively and both will transmit the Multicast packet to the LAN after receiving the Multicast data packet sent by the Multicast Source S, then the downstream node Multicast router C will receive two exactly same Multicast packets. The router needs to choose a unique transmitter through Assert mechanism after it detects this situation. An optimal transmission path is selected through sending out Assert packet. If the priority and cost of two or more path are same, then the node with larger IP address is taken as the upstream neighbor of the (S, G) entry and in charge of the transmission of the (S, G) Multicast packet.

### **5. Graft**

When the pruned downstream node needs to recover to transmission status, this node uses Graft Packet to notify upstream nodes to restore multicast data transmission.

## 48.2.2 PIM-DM Configuration Task List

1. Enable PIM-DM (Required)
2. Configure static multicast routing entries(Optional)
3. Configure additional PIM-DM parameters(Optional)
  - a) Configure the interval for PIM-DM hello messages
  - b) Configure the interval for state-refresh messages
  - c) Configure the boundary interfaces
  - d) Configure the management boundary
4. Disable PIM-DM protocol

### 1. Enable the PIM-DM protocol

When configuring the PIM-DM protocol on SGS-6341 Series Layer 3 switches, PIM multicasting should be enabled globally, then PIM-DM can be enabled for specific interfaces.

Command	Explanation
Global Mode	
<b>ip pim multicast-routing</b> <b>no ip pim multicast-routing</b>	To enable PIM-DM globally for all the interfaces (However, in order to make PIM-DM work for specific interfaces, the following command should be issued).

And then turn on PIM-SM switch on the interface

Command	Explanation
Interface Configuration Mode	
<b>ip pim dense-mode</b>	To enable PIM-DM protocol for the specified interface.(Required)

### 2. Configure static multicast routing entries

Command	Explanation
Global Configuration Mode	
<b>ip mroute &lt;A.B.C.D&gt; &lt;A.B.C.D&gt;</b> <b>&lt;ifname&gt; &lt;.ifname&gt;</b> <b>no ip mroute &lt;A.B.C.D&gt;</b> <b>&lt;A.B.C.D&gt; [&lt;ifname&gt; &lt;.ifname&gt;]</b>	To configure a static multicast routing entry. The no form of this command will remove the specified entry.

### 3. Configure additional PIM-DM parameters

- a) Configure the interval for PIM-DM hello messages

Command	Explanation
Interface Configuration Mode	

<b>ip pim hello-interval &lt; interval&gt;</b> <b>no ip pim hello-interval</b>	To configure the interval for PIM-DM hello messages. The no form of this command will restore the interval to the default value.
---	--

- b) Configure the interval for state-refresh messages

Command	Explanation
Interface Configuration Mode	
<b>ip pim state-refresh origination-interval</b> <b>no ip pim state-refresh origination-interval</b>	To configure the interval for sending PIM-DM state-refresh packets. The no form of this command will restore the default value.

- c) Configure the boundary interfaces

Command	Explanation
Interface Configuration Mode	
<b>ip pim bsr-border</b> <b>no ip pim bsr-border</b>	To configure the interface as the boundary of PIM-DM protocol. On the boundary interface, BSR messages will not be sent or received. The network connected the interface is considered as directly connected network. The no form of this command will remove the configuration.

- d) Configure the management boundary

Command	Explanation
Interface Configuration Mode	
<b>ip pim scope-border &lt;1-99 &gt;&lt;acl_name&gt;</b> <b>no ip pim scope-border</b>	To configure PIM-DM management boundary for the interface and apply ACL for the management boundary. With default settings, 239.0.0.0/8 is considered as the scope of the management group. If ACL is configured, then the scope specified by ACL permit command is the scope of the management group. The no form of this command will remove the configuration.

#### 4. Disable PIM-DM protocol

Command	Explanation
Interface Configuration Mode	
<b>no ip pim dense-mode</b>	To disable the PIM-DM protocol for the interface.
Global Configuration Mode	
<b>no ip pim multicast-routing</b>	To disable PIM-DM globally.

## 48.2.3 PIM-DM Configuration Examples

As shown in the following figure, add the Ethernet interfaces of Switch A and Switch B to corresponding vlan, and enable PIM-DM Protocol on each vlan interface.

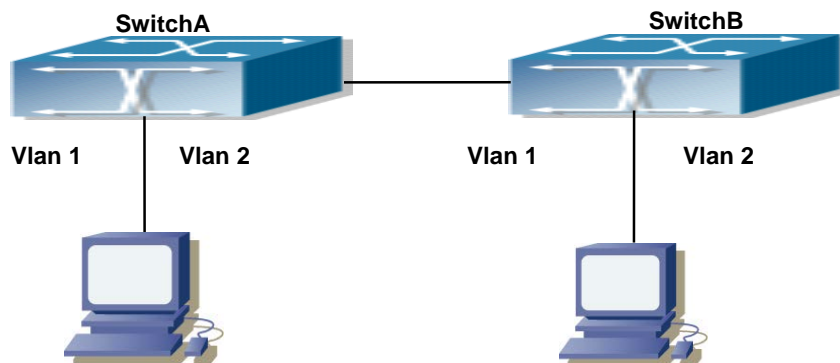

Figure 48-1 PIM-DM Typical Environment

The configuration procedure for SwitchA and SwitchB is as follows:

### (1) Configure SwitchA:

```
Switch(config)#ip pim multicast-routing
Switch(config)#interface vlan 1
Switch(Config-if-Vlan1)# ip address 10.1.1.1 255.255.255.0
Switch(Config-if-Vlan1)# ip pim dense-mode
Switch(Config-if-Vlan1)#exit
Switch(config)#interface vlan2
Switch(Config-if-Vlan2)# ip address 12.1.1.1 255.255.255.0
Switch(Config-if-Vlan2)# ip pim dense-mode
```

### (2) Configure SwitchB:

```
Switch(config)#ip pim multicast-routing
Switch(config)#interface vlan 1
Switch(Config-if-Vlan1)# ip address 12.1.1.2 255.255.255.0
Switch(Config-if-Vlan1)# ip pim dense-mode
Switch(Config-if-Vlan1)#exit
Switch(config)#interface vlan 2
Switch(Config-if-Vlan2)# ip address 20.1.1.1 255.255.255.0
Switch(Config-if-Vlan2)# ip pim dense-mode
```

At the same time, you should pay attention to the configuration of Unicast Routing Protocol, assure that each device can communicate with each other in the network layer, and be able to implement dynamic routing update in virtue of Unicast Routing Protocol.

---

## 48.2.4 PIM-DM Troubleshooting

In configuring and using PIM-DM Protocol, PIM-DM Protocol might not operate normally caused by physical connection or incorrect configuration. Therefore, the user should pay attention to the following issues:

- To assure that physical connection is correct
- To assure the Protocol of Interface and Link is UP (use show interface command)
- To assure PIM Protocol is enabled in Global Mode (use ipv6 pim multicast-routing )
- Enable PIM-DM Protocol on the interface (use ipv6 pim dense-mode command)
- Multicast Protocol requires RPF Check using Unicast routing; therefore the correctness of Unicast routing must be assured beforehand

If all attempts including Check are made but the problems on PIM-DM can't be solved yet, then use debug commands such as debug pim please, and then copy DEBUG information in 3 minutes and send to Technology Service Center.

## 48.3 PIM-SM

### 48.3.1 Introduction to PIM-SM

PIM-SM ( Protocol Independent Multicast, Sparse Mode ) is Protocol Independent Multicast Sparse Mode. It is a Multicast Routing Protocol in Sparse Mode and mainly used in big scale network with group members distributed relatively sparse and wide-spread. Unlike the Flooding & Prune of Dense Mode, PIM-SM Protocol assumes no host needs receiving Multicast data packets. PIM-SM router transmits Multicast Data Packets to a host only if it presents explicit requirement.

By setting RP (Rendezvous Point) and BSR (Bootstrap Router), PIM-SM announce Multicast packet to all PIM-SM routers and establish RPT (RP-rooted shared tree) based on RP using Join/Prune message of routers. Consequently the network bandwidth occupied by data packets and message control is cut down and the transaction cost of routers decreases. Multicast data get to the network segment where the Multicast group members are located along the shared tree flow. When the data traffic reaches a certain amount, Multicast data stream can be switched to the shortest path tree SPT based on the source to reduce network delay. PIM-SM doesn't rely on any specific Unicast Routing Protocol but make RPF Check using existing Unicast routing table.

#### 1. PIM-SM Working Principle

The central working processes of PIM-SM are: Neighbor Discovery, Generation of RP Shared Tree (RPT), Multicast source registration, SPT Switch, etc. We won't describe the mechanism of Neighbor Discovery here since it is same as that of PIM-DM.

##### (1) Generation of RP Shared Tree (RPT)

When a host joins a Multicast Group G, the leaf router that is connected to this host directly finds out through IGMP message that there is a receiver of Multicast Group G, then it works out the corresponding Rendezvous Point RP for Multicast Group G, and send join message to upper lever nodes in RP direction. Every router on the way from the leaf router to RP will generate a (\*, G) table entry, where a message from any source to Multicast group applies to this entry. When RP receives the message sent to Multicast Group G, the message will get to the leaf router along the set up path



---

and reach the host. In this way the RPT with RP as root is generated.

(2) Multicast Source Registration

When a Multicast Source S sends a Multicast packet to Multicast Group G, the PIM-SM Multicast router connected to it directly will take charge of encapsulating the Multicast packet into registered message and unicast it to corresponding RP. If there are more than one PIM-SM Multicast routers on a network segment, then DR (Designated Router) takes charge of sending the Multicast packet.

(3) SPT Switch

When the Multicast router finds that the rate of the Multicast packet from RP with destination address G exceeds threshold, the Multicast router will send Join message to the next upper level nodes in the source direction, which results in the switch from RPT to SPT.

## 2. Preparation before PIM-SM configuration

(1) Configuration Candidate RP

More than one RPs (candidate RP) can exist in PIM-SM network and each C-RP (Candidate RP) takes charge of transmitting Multicast packets with destination address in a certain range. To configure more than one candidate RPs can implement RP load share. No master or slave is differentiated among RPs. All Multicast routers work out the RP corresponding to some Multicast group based on the same algorithm after receiving the candidate RP message announced by BSR. Note that one RP can serve more than one Multicast groups and all Multicast groups. Each Multicast group can only correspond to one unique RP at any moment. It can't correspond to more than one RP at the same time.

(2) Configure BSR

BSR is the management center of PIMSM network. It is in charge of collecting messages sent by candidate RPs and broadcast them.

Only one BSR can exist within a network, but more than one C-BSR (Candidate-BSR) can be configured. In this way, if some BSR goes wrong, it can switch to another. C-BSRs elect BSR automatically.

## 48.3.2 PIM-SM Configuration Task List

1. Enable PIM-SM (Required)
2. Configure static multicast routing entries (Optional)
3. Configure additional parameters for PIM-SM (Optional)
  - (1) Configure parameters for PIM-SM interfaces
    - 1) Configure the interval for PIM-SM hello messages
    - 2) Configure the hold time for PIM-SM hello messages
    - 3) Configure ACL for PIM-SM neighbors
    - 4) Configure the interface as the boundary interface of the PIM-SM protocol
    - 5) Configure the interface as the management boundary of the PIM-SM protocol
  - (2) Configure global PIM-SM parameters
    - 1)Configure the switch as a candidate BSR
    - 2)Configure the switch as a candidate RP
    - 3)Configure static RP
    - 4)Configure the cache time of kernel multicast route
4. Disable PIM-SM Protocol

### 1. Enable PIM-SM Protocol

The PIM-SM protocol can be enabled on SGS-6341 Series Layer 3 switches by enabling PIM in global configuration mode and then enabling PIM-SM for specific interfaces in the interface configuration mode.

Command	Explanation
Global Mode	
<b>ip pim multicast-routing</b>	To enable the PIM-SM protocol for all the interfaces (However, in order to make PIM-SM work for specific interfaces, the following command should be issued).(Required)

And then turn on PIM-SM switch on the interface

Command	Explanation
Interface Configuration Mode	
<b>ip pim sparse-mode</b>	Enable PIM-SM Protocol of the interface. (Required).

### 2. Configure static multicast routing entries

Command	Explanation
Global Configuration Mode	
<b>ip mroute &lt;A.B.C.D&gt; &lt;A.B.C.D&gt; &lt;ifname&gt; &lt;ifname&gt; no ip mroute &lt;A.B.C.D&gt; &lt;A.B.C.D&gt; [&lt;ifname&gt; &lt;ifname&gt;]</b>	To configure a static multicast routing entry. The no form of this command will remove the specified static multicast routing entry.

### 3. Configure additional parameters for PIM-SM

(1) Configure parameters for PIM-SM interfaces

1) Configure the interval for PIM-SM hello messages

Command	Explanation
Interface Configuration Mode	
<b>ip pim hello-interval &lt;interval&gt; no ip pim hello-interval</b>	To configure the interval for PIM-SM hello messages. The no form of this command restores the interval to the default value.

2) Configure the hold time for PIM-SM hello messages

Command	Explanation
Interface Configuration Mode	

<b>ip pim hello-holdtime &lt;value&gt;</b> <b>no ip pim hello-holdtime</b>	To configure the value of the holdtime field in the PIM-SM hello messages. The no form of this command will restore the hold time to the default value.
---	---

3) Configure ACL for PIM-SM neighbors

Command	Explanation
Interface Configuration Mode	
<b>ip pim neighbor-filter{&lt;access-list-number &gt; }</b> <b>no ip pim neighbor-filter{&lt;access-list-number &gt; }</b>	To configure ACL to filter PIM-SM neighbors. If session to the neighbor has been denied by ACL, then the sessions that have been set up will be discarded immediately and new sessions will not be set up.

4) Configure the interface as the boundary interface of the PIM-SM protocol

Command	Explanation
Interface Configuration Mode	
<b>ip pim bsr-border</b> <b>no ip pim bsr-border</b>	To configure the interface as the boundary of PIM-SM protocol. On the boundary interface, BSR messages will not be sent or received. The network connected the interface is considered as directly connected network. The no form of this command will remove the configuration.

5) Configure the interface as the management boundary of the PIM-SM protocol

Command	Explanation
Interface Configuration Mode	
<b>ip pim scope-border &lt;1-99 &gt;   &lt;acl_name&gt;</b> <b>no ip pim scope-border</b>	To configure PIM-SM management boundary for the interface and apply ACL for the management boundary. With default settings, 239.0.0.0/8 is considered as the scope of the management group. If ACL is configured, then the scope specified by ACL permit command is the scope of the management group. acl_name should be standard IPv4 ACL name. The no form of this command will remove the configuration.

(2) Configure global PIM-SM parameter

- 1) Configure the switch as a candidate BSR

Command	Explanation
Global Configuration Mode	
<b>ip pim bsr-candidate {vlan &lt;vlan-id&gt;  &lt;ifname&gt;}[ &lt;mask-length&gt;][ &lt;priority&gt; ]</b> <b>no ip pim bsr-candidate</b>	This command is the global candidate BSR configuration command, which is used to configure the information of PIM-SM candidate BSR so that it can compete for BSR router with other candidate BSR. The “ <b>no ip pim bsr-candidate</b> ” command cancels the configuration of BSR.

2) Configure the switch as a candidate RP

Command	Explanation
Global Configuration Mode	
<b>ip pim rp-candidate { vlan &lt;vlan-id&gt;  lookback&lt;index&gt; &lt;ifname&gt; } [&lt;A.B.C.D&gt;][&lt;priority&gt;]</b> <b>no ip pim rp-candidate</b>	This command is the global candidate RP configuration command, which is used to configure the information of PIM-SM candidate RP so that it can compete for RP router with other candidate RP. The “ <b>no ip pim rp-candidate</b> ” command cancels the configuration of RP.

3) Configure static RP

Command	Explanation
Global Configuration Mode	
<b>ip pim rp-address &lt;A.B.C.D&gt; [&lt;A.B.C.D/M&gt;]</b> <b>no ip pim rp-address &lt;A.B.C.D&gt; {&lt;all&gt; &lt;A.B.C.D/M&gt;}</b>	The command is the multicast group configuration static RP of the globally or multicast address range. The no form of this command will remove the configuration for the static RP.

4) Configure the cache time of kernel multicast route

Command	Explanation
Global Configuration Mode	
<b>ip multicast unresolved-cache aging-time &lt;value&gt;</b> <b>no ip multicast unresolved-cache aging-time</b>	Configure the cache time of kernel multicast route, the no command restores the default value.

]

#### 4. Disable PIM-SM Protocol

Command	Explanation
Interface Configuration Mode	
<b>no ip pim sparse-mode   no ip pim multicast-routing(Global configuration mode)</b>	To disable the PIM-SM protocol.

### 48.3.3 PIM-SM Configuration Examples

As shown in the following figure, add the Ethernet interfaces of SwitchA, SwitchB, SwitchC and SwitchD to corresponding VLAN, and enable PIM-SM Protocol on each VLAN interface.

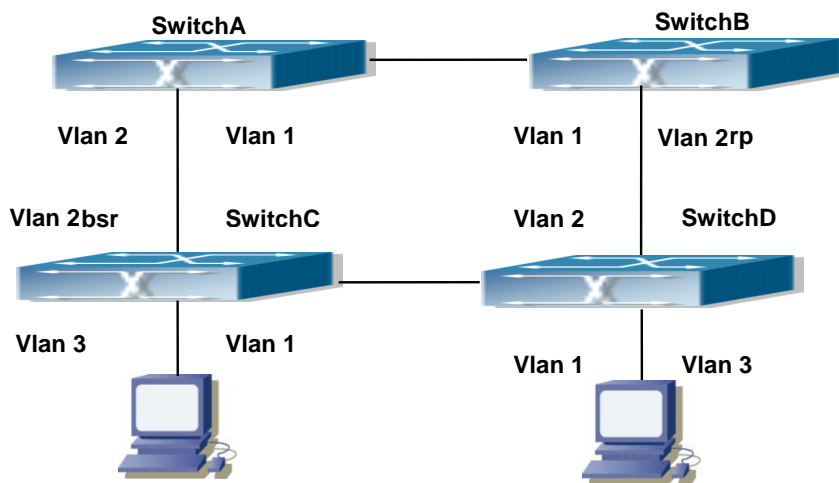

Figure 48-2 PIM-SM Typical Environment

The configuration procedure for SwitchA, SwitchB, SwitchC and SwitchD is as follows:

#### (1) Configure SwitchA:

```
Switch(config)#ip pim multicast-routing
Switch(config)#interface vlan 1
Switch(Config-if-Vlan1)# ip address 12.1.1.1 255.255.255.0
Switch(Config-if-Vlan1)# ip pim sparse-mode
Switch(Config-if-Vlan1)#exit
Switch(config)#interface vlan 2
Switch(Config-if-Vlan2)# ip address 13.1.1.1 255.255.255.0
Switch(Config-if-Vlan2)# ip pim sparse-mode
```

#### (2) Configure SwitchB:

```
Switch(config)#ip pim multicast-routing
Switch(config)#interface vlan 1
Switch(Config-if-Vlan1)# ip address 12.1.1.2 255.255.255.0
```

```
Switch(Config-if-Vlan1)# ip pim sparse-mode
Switch(Config-if-Vlan1)#exit
Switch(config)#interface vlan 2
Switch(Config-if-Vlan2)# ip address 24.1.1.2 255.255.255.0
Switch(Config-if-Vlan2)# ip pim sparse-mode
Switch(Config-if-Vlan2)# exit
Switch(config)# ip pim rp-candidate vlan2
```

### **(3) Configure SwitchC:**

```
Switch(config)#ip pim multicast-routing
Switch(config)#interface vlan 1
Switch(Config-if-Vlan1)# ip address 34.1.1.3 255.255.255.0
Switch(Config-if-Vlan1)# ip pim sparse-mode
Switch(Config-if-Vlan1)#exit
Switch(config)#interface vlan 2
Switch(Config-if-Vlan2)# ip address 13.1.1.3 255.255.255.0
Switch(Config-if-Vlan2)# ip pim sparse-mode
Switch(Config-if-Vlan2)#exit
Switch(config)#interface vlan 3
Switch(Config-if-Vlan3)# ip address 30.1.1.1 255.255.255.0
Switch(Config-if-Vlan3)# ip pim sparse-mode
Switch(Config-if-Vlan3)# exit
Switch(config)# ip pim bsr-candidate vlan2 30 10
```

### **(4) Configure SwitchD:**

```
Switch(config)#ip pim multicast-routing
Switch(config)#interface vlan 1
Switch(Config-if-Vlan1)# ip address 34.1.1.4 255.255.255.0
Switch(Config-if-Vlan1)# ip pim sparse-mode
Switch(Config-if-Vlan1)#exit
Switch(config)#interface vlan 2
Switch(Config-if-Vlan2)# ip address 24.1.1.4 255.255.255.0
Switch(Config-if-Vlan2)# ip pim sparse-mode
Switch(Config-if-Vlan2)#exit
Switch(config)#interface vlan 3
Switch(Config-if-Vlan3)# ip address 40.1.1.1 255.255.255.0
Switch(Config-if-Vlan3)# ip pim sparse-mode
```

At the same time, you should pay attention to the configuration of Unicast Routing Protocol, assure that each device can communicate with each other in the network layer, and be able to implement dynamic routing update in virtue of Unicast Routing Protocol.

---

## 48.3.4 PIM-SM Troubleshooting

In configuring and using PIM-SM Protocol, PIM-SM Protocol might not operate normally caused by physical connection or incorrect configuration. Therefore, the user should pay attention to the following issues:

- Assure that physical connection is correct;
- Assure the Protocol of Interface and Link is UP (use show interface command);
- Assure that PIM Protocol is enabled in Global Mode (use ip pim multicast-routing);
- Assure that PIM-SM is configured on the interface (use ip pim sparse-mode);
- Multicast Protocol requires RPF Check using unicast routing; therefore the correctness of unicast routing must be assured beforehand;
- PIM-SM Protocol requires supports by RP and BSR, therefore you should use show ip pim bsr-router first to see if there is BSR information. If not, you need to check if there is unicast routing leading to BSR.
- Use show ip pim rp-hash command to check if RP information is correct; if there is not RP information, you still need to check unicast routing.

If all attempts including Check are made but the problems on PIM-SM can't be solved yet, then use debug commands such debug pim/debug pim BSR please, and then copy DEBUG information in 3 minutes and send to Technology Service Center.

## 48.4 MSDP Configuration

### 48.4.1 Introduction to MSDP

MSDP – Multicast Source Discovery Protocol, is a protocol that can learn information about multicast source in other PIM-SM domain. The RP on which MSDP is configured will advertise the information about the multicast sources in its domain to all the other MSDP entities through SA messages. Thus, all the information about multicast sources in one PIM-SM domain is spread to another. In MSDP, inter-domain information tree is used other than the shared tree. It is required that the multicast routing protocol used for in-domain routing must be PIM-SM.

- The work flow for RP in PIM-SM protocol

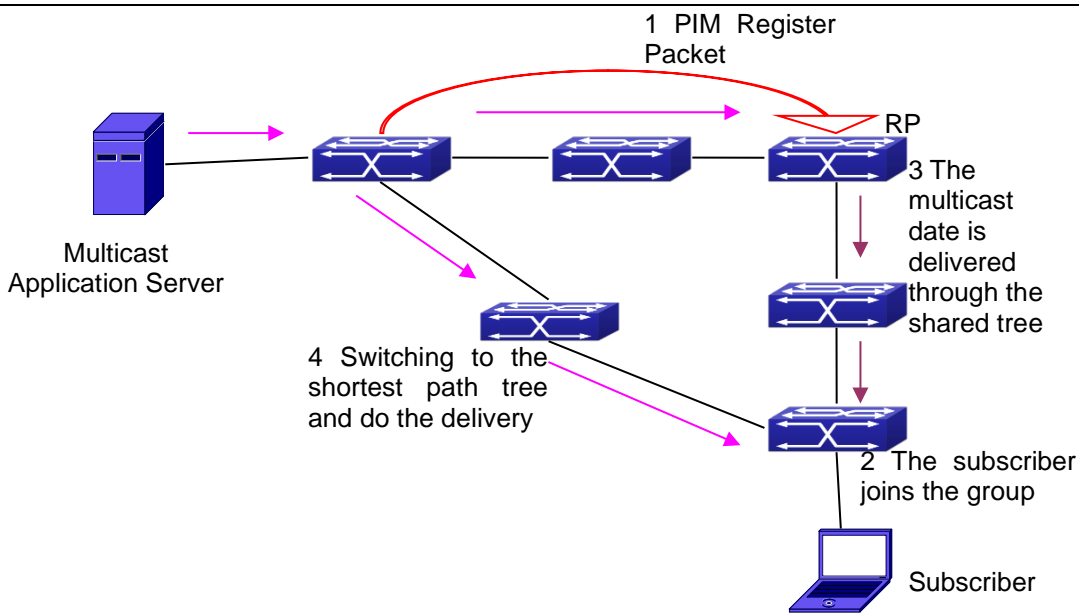

## 48.4.2 Brief Introduction to MSDP Configuration Tasks

1. Configuration of MSDP Basic Function
  - 1) Enabling MSDP (Required)
  - 2) Configuring MSDP entities (Required)
  - 3) Configuring the Connect-Source interface
  - 4) Configuring static RPF entities
  - 5) Configuring Originator RP
  - 6) Configuring TTL value
2. Configuration of MSDP entities
  - 1) Configuring the Connect-Source interface
  - 2) Configuring the descriptive information for MSDP entities
  - 3) Configuring the AS number
  - 4) Configuring the specified mesh group of MSDP
  - 5) Configuring the maximum size for the cache
3. Configurations on delivery of SA packets
  - 1) Configuring filter policies for creation of SA packets
  - 2) Configuring filter rules on how to receive and forward SA packets
  - 3) Configuring SA request packets
  - 4) Configuring filter policies for SA-Request packets
4. Configuration of parameters of SA-cache
  - 1) Configuring SA packets cache
  - 2) Configuring the aging time for entries in SA packets cache
  - 3) Configuring the maximum size for the cache

## 48.4.3 Configuration of MSDP Basic Function

All the commands in this section are configured for RP in the PIM-SM domain. These RP will function as the other peer of the MSDP entities.



---

### 48.4.3.1 Prerequisites of MSDP Configuration

Before the MSDP basic functions can be configured, the following tasks should be done:

- At least one single cast routing protocol should be configured, in order to connect the network inside the domain and outside
- Configure PIM-SM in order to implement multicast inside the domain

When configuring MSDP basic function, the following information should be ready:

- The IP address of MSDP entities
- Filter policy table

Pay attention: MSDP can not use with Any-cast RP at same time, but configure Any-cast RP of based MSDP protocol.

### 48.4.3.2 Enabling MSDP

MSDP should be enabled before various MSDP functions can be configured.

1. Enable the MSDP function
2. Configure MSDP

#### 1. Enabling MSDP

Commands	Explanation
Global Configuration Mode	
<b>router msdp</b> <b>no router msdp</b>	To enable MSDP. The no form of this command will disable MSDP globally.

#### 2. Configuration of MSDP parameters

Commands	Explanation
MSDP Configuration Mode	
<b>connect-source &lt;interface-type&gt;</b> <b>&lt;interface-number&gt;</b> <b>no connect-source</b>	To configure the Connect-Source interface for MSDP Peer. The no form of this command will remove the configured Connect-Source interface.
<b>default-rpf-peer &lt;peer-address&gt; [ rp-policy</b> <b>&lt;acl-list-number&gt;   &lt;word&gt; ]</b> <b>no default-rpf-peer</b>	To configure static RPF Peer. The no form of this command will remove the configured RPF Peer.
<b>originating-rp &lt;interface-type&gt;</b> <b>&lt;interface-number&gt;</b> <b>no originating-rp</b>	To configure Originator-RP. The no form of this command will remove the configured Originator-RP.
<b>ttl-threshold &lt;ttl&gt;</b> <b>no ttl-threshold</b>	To configure the TTL value. The no form of this command will remove the configured TTL value.

---

## 48.4.4 Configuration of MSDP Entities

### 48.4.4.1 Creation of MSDP Peer

Commands	Explanation
MSDP Configuration Mode	
<b>peer &lt;peer-address&gt;</b> <b>no peer &lt;peer-address&gt;</b>	To create a MSDP Peer. The no form of this command will remove the configured MSDP Peer.

### 48.4.4.2 Configuration of MSDP parameters

Commands	Explanation
MSDP Peer Configuration Mode	
<b>connect-source &lt;interface-type&gt;</b> <b>&lt;interface-number&gt;</b> <b>no connect-source</b>	To configure the Connect-Source interface for MSDP Peer. The no form of this command will remove the configured Connect-Source interface.
<b>description &lt;text&gt;</b> <b>no description</b>	To configure the descriptive information about the MSDP entities. The no form of this command will remove the configured description.
<b>remote-as &lt;as-num&gt;</b> <b>no remote-as &lt;as-num&gt;</b>	To configure the AS number for MSDP Peer. The no form of this command will remove the configured AS number of MSDP Peer.
<b>mesh-group &lt;name&gt;</b> <b>no mesh-group &lt;name&gt;</b>	To configure an MSDP Peer to join the specified mesh group. The no form of this command will remove the MSDP Peer from the specified mesh group.

### 48.4.5 Configuration of Delivery of MSDP Packet

Commands	Explanation
MSDP Configuration Mode	
<b>redistribute [list &lt;acl-list-number</b> <b>/acl-name&gt;]</b> <b>no redistribute</b>	To configure the filter rules for creation of SA packets. The no form of this command will remove the configured.

MSDP Configuration Mode or MSDP Peer Configuration Mode	
<b>sa-filter</b> (in out) [ list <acl-number / acl-name>   rp-list <rp-acl-number / rp-acl-name>] <b>no sa-filter</b> (in out) [[ list <acl-number / acl-name>   rp-list <rp-acl-number / rp-acl-name>]	To configure the filter rules for receiving and forwarding SA packets. The no form of this command will remove the configured rules.
MSDP Peer Configuration Mode	
<b>sa-request</b> <b>no sa-request</b>	To configure sending of SA request packets. The no form of this command will disable sending of SA request packets.
MSDP Configuration Mode	
<b>sa-request-filter</b> [list <access-list-number   access-list-name>] <b>no sa-request-filter</b> [list <access-list-number   access-list-name>]	To configure filter rules for receiving SA request packets. The no form of this command will remove the configured filter rules for SA request packets.

#### 48.4.6 Configuration of Parameters of SA-cache

Commands	Explanation
MSDP Configuration Mode	
<b>cache-sa-state</b> <b>no cache-sa-state</b>	To enable the SA packet cache. To disable the SA packets cache.
MSDP Configuration Mode	
<b>cache-sa-holdtime</b> <150-3600> <b>no cache-sa-holdtime</b>	The aging time for entries in the SA cache. To restore the default aging time configuration.
MSDP Configuration Mode or MSDP Peer Configuration Mode	
<b>cache-sa-maximum</b> <sa-limit> <b>no cache-sa-maximum</b>	To configure the maximum size for the SA cache. To restore the size of the SA cache to the default value.

#### 48.4.7 MSDP Configuration Examples

Example 1: MSDP basic function.

Multicast Configuration:

1. Suppose the multicast server is sending multicast datagram at 224.1.1.1;
2. The designated router – DR, which is connected to the multicast server, encapsulate the multicast datagram in the Register packets and send them to the RP(RP1) in the local domain;
3. The RP unwraps the packets and sends them to all the domain members through the shared tree. The members in the domain can be configured to be or not to be in the shared tree;

4. At the same time, the source RP in the domain, generates a SA – Source Active message, and send it to the MSDP entity – RP2.
5. If there's another member in the same domain with the MSDP entity which is named as RP3, RP3 will distribute the multicast datagram encapsulated in the SA messages to the members of the shared tree, and send join messages to the multicast source. That means RP creates an entry (S, G), and send join messages for (S, G) hop by hop, so that (S, G) can reach the SPT which takes the multicast source as the root across the PIM-SM domain.  
If there no members in the same domain with MSDP entity – RP2, RP2 will not create the (S, G) entry nor it will join the SPT which takes the multicast source as the root.
6. When the reverse route has been set up, the multicast datagram from the source will be directly delivered to RP3, and RP will forward the datagram to the shared tree. At this time, the router which is closest to the domain members can determine itself whether or not to switch to SPT.

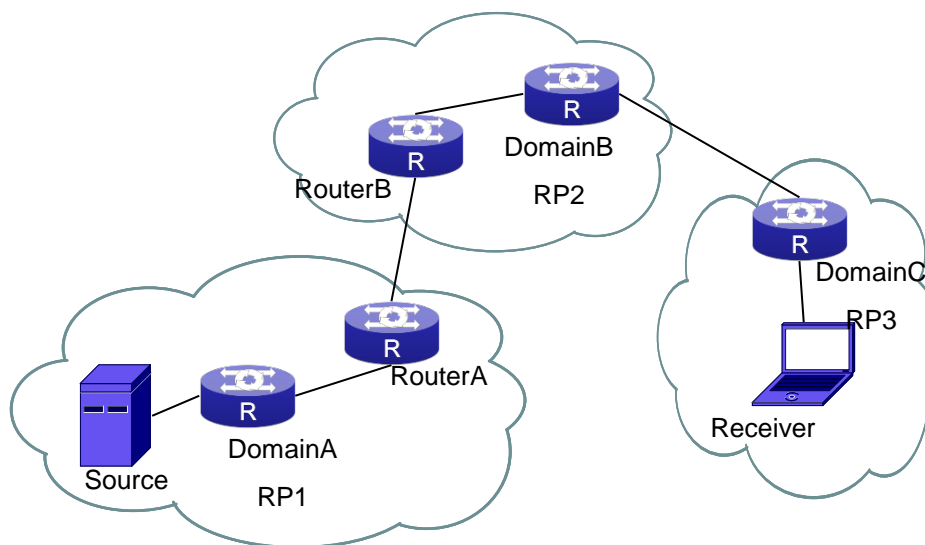

**Figure 48-3** Network Topology for MSDP Entry

**Configuration tasks are listed as below:**

**Prerequisites:**

Enable the single cast routing protocol and PIM protocol on every router, and make sure that the inter-domain routing works well and multicasting inside the domain works well.

Suppose the multicast server S in Domain A offers multicast programs at 224.1.1.1. A host in Domain C named R subscribes this program. Before MSDP is configured C cannot subscribe the multicast program. However, with the following configuration, R is able to receive programs offered by S.

**RP1 in Domain A:**

```
Switch#config
Switch(config)#interface vlan 1
Switch(Config-if-Vlan1)#ip address 10.1.1.1 255.255.255.0
Switch(Config-if-Vlan1)#exit
Switch(config)#router msdp
Switch(router-msdp)#peer 10.1.1.2
```

---

**Router A in Domain A:**

```
Switch#config
Switch(config)#interface vlan 1
Switch(Config-if-Vlan1)#ip address 10.1.1.2 255.255.255.0
Switch(Config-if-Vlan1)#exit
Switch(config)#interface vlan 2
Switch(Config-if-Vlan2)#ip address 20.1.1.2 255.255.255.0
Switch(Config-if-Vlan2)#exit
Switch(config)#router msdp
Switch(router-msdp)#peer 10.1.1.1
Switch(msdp-peer)#exit
Switch(router-msdp)#peer 20.1.1.1
```

**Router B in Domain B:**

```
Switch#config
Switch(config)#interface vlan 2
Switch(Config-if-Vlan2)#ip address 20.1.1.1 255.255.255.0
Switch(Config-if-Vlan2)#exit
Switch(Config)#interface vlan 3
Switch(Config-if-Vlan3)#ip address 30.1.1.1 255.255.255.0
Switch(Config-if-Vlan3)#exit
Switch(config)#router msdp
Switch(router-msdp)#peer 20.1.1.2
Switch(msdp-peer)#exit
Switch(router-msdp)#peer 30.1.1.2
```

**RP2 in Domain B:**

```
Switch#config
Switch(config)#interface vlan 3
Switch(Config-if-Vlan3)#ip address 30.1.1.2 255.255.255.0
Switch(config)#interface vlan 4
Switch(Config-if-Vlan4)#ip address 40.1.1.2 255.255.255.0
Switch(Config-if-Vlan4)#exit
Switch(config)#router msdp
Switch(router-msdp)#peer 30.1.1.1
Switch(config)#router msdp
Switch(router-msdp)#peer 40.1.1.1
```

**RP3 in Domain C:**

```
Switch(config)#interface vlan 4
Switch(Config-if-Vlan1)#ip address 40.1.1.1 255.255.255.0
Switch(Config-if-Vlan1)#exit
```

```
Switch(config)#router msdp
Switch(router-msdp)#peer 40.1.1.2
```

Example 2: Application of MSDP Mesh-Group.

Mesh-Group can be used to reduce flooding of SA messages. The Peers which are meshed in the same domain can be configured as a Mesh-Group. All the members in the same mesh group use a unique group name.

As it is shown in **Figure**, when Mesh-Group is configured for the four meshed Peers in the same domain, flooding of SA messages reduced remarkably.

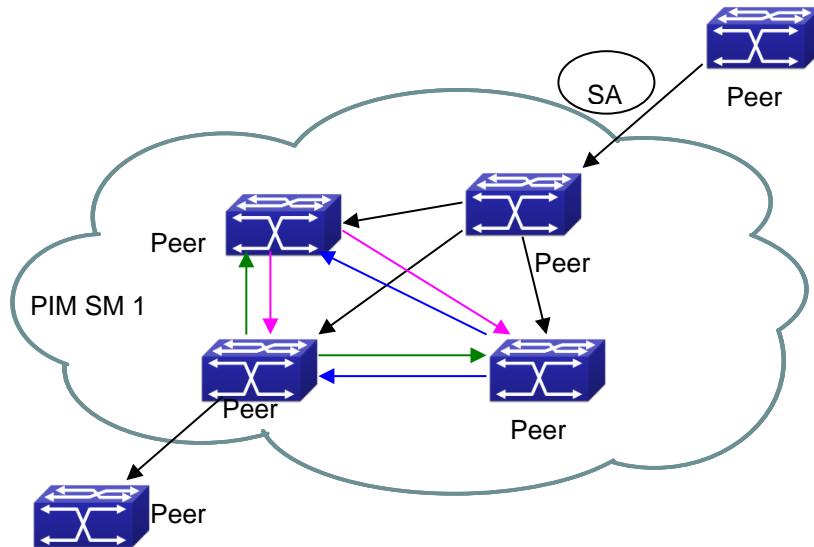

Figure 48-4 Flooding of SA messages

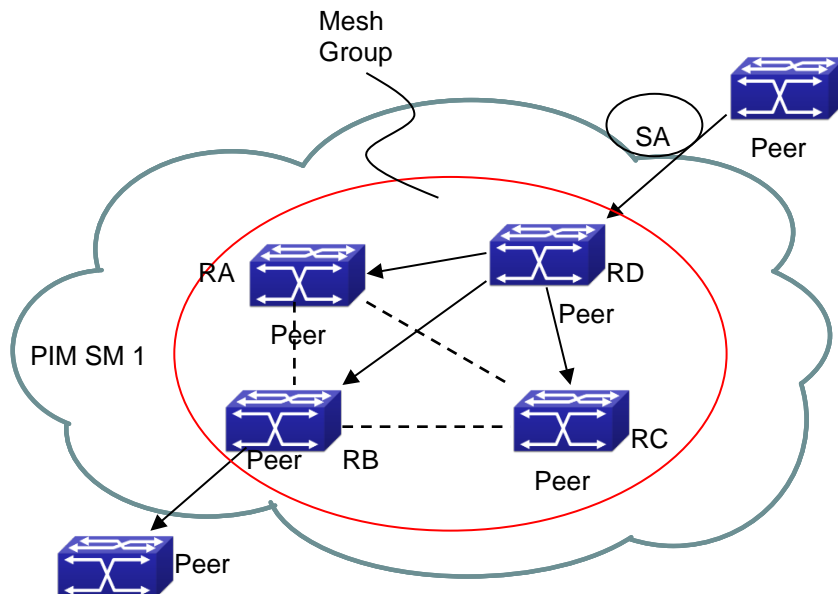

Figure 48-5 Flooding of SA messages with mesh group configuration

---

**Configuration steps are listed as below:**

**Router A:**

```
Switch#config
Switch(config)#interface vlan 1
Switch(Config-if-Vlan1)#ip address 10.1.1.1 255.255.255.0
Switch(Config-if-Vlan1)#exit
Switch(config)#interface vlan 2
Switch(Config-if-Vlan2)#ip address 20.1.1.1 255.255.255.0
Switch(Config-if-Vlan2)#exit
Switch(config)#interface vlan 3
Switch(Config-if-Vlan3)#ip address 30.1.1.1 255.255.255.0
Switch(Config-if-Vlan3)#exit
Switch(config)#router msdp
Switch(router-msdp)#peer 10.1.1.2
Switch(router-msdp)#mesh-group SGS6341-1
Switch(msdp-peer)#exit
Switch(router-msdp)#peer 20.1.1.4
Switch(router-msdp)#mesh-group SGS6341-1
Switch(msdp-peer)#exit
Switch(router-msdp)#peer 30.1.1.3
Switch(router-msdp)#mesh-group SGS6341-1
Switch(msdp-peer)#exit
```

**Router B:**

```
Switch#config
Switch(config)#interface vlan 1
Switch(Config-if-Vlan1)#ip address 10.1.1.2 255.255.255.0
Switch(Config-if-Vlan1)#exit
Switch(config)#interface vlan 4
Switch(Config-if-Vlan4)#ip address 40.1.1.2 255.255.255.0
Switch(Config-if-Vlan4)#exit
Switch(config)#interface vlan 6
Switch(Config-if-Vlan6)#ip address 60.1.1.2 255.255.255.0
Switch(Config-if-Vlan6)#exit
Switch(config)#router msdp
Switch(router-msdp)#peer 10.1.1.1
Switch(router-msdp)#mesh-group SGS6341-1
Switch(msdp-peer)#exit
Switch(router-msdp)#peer 40.1.1.4
Switch(router-msdp)#mesh-group SGS6341-1
Switch(msdp-peer)#exit
Switch(router-msdp)#peer 60.1.1.3
```

```
Switch(router-msdp)#mesh-group SGS6341-1
```

#### Router C:

```
Switch#config
Switch(config)#interface vlan 4
Switch(Config-if-Vlan4)#ip address 40.1.1.4 255.255.255.0
Switch(Config-if-Vlan4)#exit
Switch(config)#interface vlan 5
Switch(Config-if-Vlan5)#ip address 50.1.1.4 255.255.255.0
Switch(Config-if-Vlan5)#exit
Switch(config)#interface vlan 6
Switch(Config-if-Vlan6)#ip address 60.1.1.4 255.255.255.0
Switch(Config-if-Vlan6)#exit
Switch(config)#router msdp
Switch(router-msdp)#peer 20.1.1.1
Switch(router-msdp)#mesh-group SGS6341-1
Switch(msdp-peer)#exit
Switch(router-msdp)#peer 40.1.1.4
Switch(router-msdp)#mesh-group SGS6341-1
Switch(msdp-peer)#exit
Switch(router-msdp)#peer 60.1.1.2
Switch(router-msdp)#mesh-group SGS6341-1
```

#### Router D:

```
Switch#config
Switch(config)#interface vlan 2
Switch(Config-if-Vlan2)#ip address 20.1.1.4 255.255.255.0
Switch(Config-if-Vlan2)#exit
Switch(config)#interface vlan 4
Switch(Config-if-Vlan1)#ip address 40.1.1.4 255.255.255.0
Switch(Config-if-Vlan1)#exit
Switch(config)#interface vlan 5
Switch(Config-if-Vlan5)#ip address 50.1.1.4 255.255.255.0
Switch(Config-if-Vlan5)#exit
Switch(config)#router msdp
Switch(router-msdp)#peer 20.1.1.1
Switch(router-msdp)#mesh-group SGS6341-1
Switch(msdp-peer)#exit
Switch(router-msdp)#peer 40.1.1.2
Switch(router-msdp)#mesh-group SGS6341-1
Switch(msdp-peer)#exit
Switch(router-msdp)#peer 50.1.1.3
Switch(router-msdp)#mesh-group SGS6341-1
```



---

## 48.4.8 MSDP Troubleshooting

When MSDP is being configured, it may not function because of the physical link not working or configuration mistakes. Attention should be paid to the following items in order to make MSDP work:

- Make sure the physical link works well
- Make sure inner-domain and inter-domain routing works
- Make sure PIM-SM is applied in every domain as the inner-domain routing protocol, and configuration for PIM-SM works well
- Make sure MSDP is enabled, and the link status of the MSDP enabled Peer is UP
- Use the command **show msdp global** to check whether the MSDP configuration is correct

If the MSDP problems cannot be solved through all the methods provided above, please issue the command **debug msdp** to get the debugging messages within three minutes, and send them to the technical service center of our company.

## 48.5 ANYCAST RP Configuration

### 48.5.1 Introduction to ANYCAST RP

Anycast RP is a technology based on PIM protocol, which provides redundancy in order to recover as soon as possible once an RP becomes unusable.

The kernel concept of Anycast RP is that the RP addresses configured all over the whole network exist on multiple multicast servers (the most common situation is that every device providing ANYCAST RP uses LOOPBACK interface, and using the longest mask to configures RP addresses on this interface), while the unicast routing algorithm will make sure that PIM routers can always find the nearest RP, thus , providing a shorter and faster way to find RP in a larger network., Once an RP being used becomes unusable, the unicast routing algorithm will ensure that the PIM router can find a new RP path fast enough to recover the multicast server in time. Multiple RP will cause a new problem that is if the multicast source and the receivers are registered to different RP, some receivers will not be able to receive data of multicast source (obviously, the register messages only prefer the nearest RP). So, in order to keep the communication between all RP, Anycast RP defines that the nearest RP to the multicast source should forward the source register messages to all the other RP to guarantee that all joiners of the RP can find the multicast source.

The method to realize the PIM-protocol-based Anycast RP is that: maintaining an ANYCAST RP list on every switch configured with Anycast RP and using another address as the label to identify each other. When one Anycast RP device receives a register message, it will send the register message to other Anycast RP devices while using its own address as the source address, to notify all the other devices of the original destination.

## 48.5.2 ANYCAST RP Configuration Task

1. Enable ANYCAST RP v4 function
2. Configure ANYCAST RP v4

### 1. Enable ANYCAST RP v4 function

Command	Explanation
Global Configuration Mode	
<b>ip pim anycast-rp</b> <b>no ip pim anycast-rp</b>	Enable ANYCAST RP function. (necessary) No operation will globally disable ANYCAST RP function.

### 2. Configure ANYCAST RP v4

- (1) Configure the RP candidate

Command	Explanation
Global Configuration Mode	
<b>ip pim rp-candidate {vlan&lt;vlan-id&gt;   loopback&lt;index&gt;   &lt;ifname&gt;} [&lt;A.B.C.D&gt;] [&lt;priority&gt;]</b> <b>no ip pim rp-candidate</b>	Now, the PIM-SM has allowed the Loopback interface to be a RP candidate.(necessary) Please pay attention to that, ANYCAST RP protocol can configure the Loopback interface or a regular three-layer VLAN interface to be the RP candidate. In make sure that PIM routers in the network can find where the RP locates, the RP candidate interface should be added into the router. No operation will cancel the RP candidate configuration on this router.

- (2) Configure self-rp-address (the RP address of this router)

Command	Explanation
Global Configuration Mode	
<b>ip pim anycast-rp self-rp-address A.B.C.D</b> <b>no ip pim anycast-rp self-rp-address</b>	Configure the self-rp-address of this router (as a RP). This address can be used to exclusively identify this router when communicating with other RP. the effect of <b>self-rp-address</b> refers to two respects: 1 Once this router (as a RP) receives the register message from DR unicast, it needs to forward the register message to all the other RP in the network, notifying them of the state

	<p>of source (S,G). While forwarding the register message, this router will change the source address of it into self-rp-address.</p> <p>2 Once this router(as a RP) receives a register message from other RP unicast, such as a register message whose destination is the self-rp-address of this router, it will create (S,G) state and send back a register-stop message, whose destination address is the source address of the register message.</p> <p>Pay attention: self-rp-address has to be the address of a three-layer interface on this router, but the configuration is allowed to be done with the absence of the interface. The self-rp-address should be unique.</p> <p>No operation will cancel the self-rp-address which is used to communicate with other RPs by this router (as a RP).</p>
--	--

(3) Configure other-rp-address (other RP communication addresses)

Command	Explanation
Global Configuration Mode	
<pre>ip pim anycast-rp &lt;anycast-rp-addr&gt; &lt;other-rp-addr&gt; no ip pim anycast-rp &lt;anycast-rp-addr&gt; &lt;other-rp-addr&gt;</pre>	<p>Configure anycast-rp-addr on this router (as a RP). This unicast address is actually the RP address configured on multiple RP in the network, in accordance with the address of RP candidate interface (or Loopback interface).</p> <p>The effect of <b>anycast-rp-addr</b> includes:</p> <p>1 Although more than one anycast-rp-addr addresses are allowed to be configured, only the one having the same address with the currently configured RP candidate address will take effect. Only after that, can the other-rp-address in accordance with this anycast-rp-addr take effect.</p> <p>2 The configuration is allowed to be done with the absence of the interface in accordance with the anycast-rp-addr.</p> <p>Configure on this router (as a RP) the other-rp-addresses of other RP communicating with it. This unicast address identifies other RP and is used in the</p>

communication with local routers.

The effect of **other-rp-address** refers to two respects:

- 1 Once this router (as a RP) receives the register message from a DR unicast, it should forward it to other RP in the network to notify all the RP in the network of the source (S.G) state. While forwarding, the router will change the destination address of the register message into other-rp-address.
- 2 Multiple other-rp-addresses can be configured in accordance with one anycast-rp-addr, Once the register message from a DR is received, it should be forwarded to all of these other RP one by one.

No operation will cancel an other-rp-address communicating with this router.

### 48.5.3 ANYCAST RP Configuration Examples

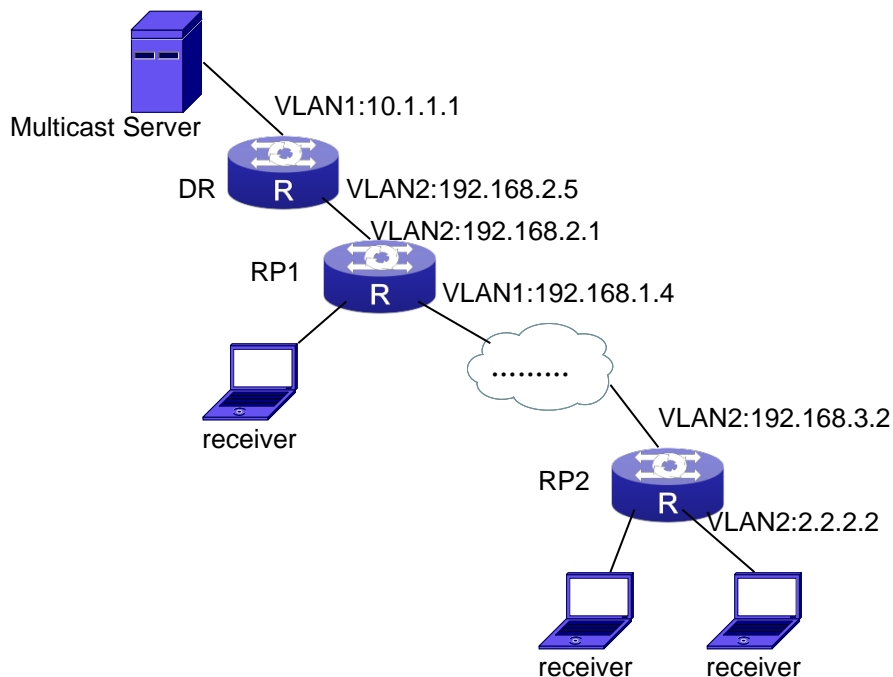

**Figure 48-6** The ANYCAST RP v4 function of the router

As shown in the **Figure**, the overall network environment is PIM-SM, which provides two routers supporting ANYCAST RP, RP1 and RP2. Once multicast data from the multicast source server reaches the DR, the DR will send a multicast source register message to the nearest RP unicast according to the unicast routing algorithm, which is RP1 in this example. When RP1 receives the register message from the DR, besides redistributing to the shared tree according to the orders who already join it, it will forward the multicast register message to RP2 to guarantee that all orders that already join RP2 can find the multicast source.

---

Since there is an ANYCAST list maintained on router RP1 that has been configured with ANYCAST RP, and since this list contains the unicast addresses of all the other RP in the network, when the RP1 receives the register message, it can use the self-r-address, which identifies itself as the source address to forward the register message to RP2. The cloud in the **Figure** represents the PIM-SM network operation between RP1 and RP2.

**The following is the configuration steps:**

**RP1 Configuration:**

```
Switch#config
Switch(config)#interface loopback 1
Switch(Config-if-Loopback1)#ip address 1.1.1.1 255.255.255.255
Switch(Config-if-Loopback1)#exit
Switch(config)#ip pim rp-candidate loopback 1
Switch(config)#ip pim bsr-candidate vlan 1
Switch(config)#ip pim multicast-routing
Switch(config)#ip pim anycast-rp
Switch(config)#ip pim anycast-rp self-rp-address 192.168.2.1
Switch(config)#ip pim anycast-rp 1.1.1.1 192.168.3.2
```

**RP2 Configuration:**

```
Switch#config
Switch(config)#interface loopback 1
Switch(Config-if-Loopback1)#ip address 1.1.1.1 255.255.255.255
Switch(Config-if-Loopback1)#exit
Switch(config)#ip pim rp-candidate loopback 1
Switch(config)#ip pim multicast-routing
Switch(config)#ip pim anycast-rp
Switch(config)#ip pim anycast-rp self-rp-address 192.168.3.2
Switch(config)#ip pim anycast-rp 1.1.1.1 192.168.2.1
```

## 48.5.4 ANYCAST RP Troubleshooting

When configuring and using ANYCAST RP function, the ANYCAST RP might work abnormally because of faults in physical connections, configurations or something others. So, the users should pay attention to the following points:

- The physical connections should be guaranteed to be correct
- The PIM-SM protocol should be guaranteed to operate normally
- The ANYCAST RP should be guaranteed to be enabled in Global configuration mode
- The self-rp-address should be guaranteed to be configured correctly in Global configuration mode
- The other-rp-address should be guaranteed to be configured correctly in Global configuration mode
- All the interface routers should be guaranteed to be correctly added, including the loopback interface as a RP

- 
- Use “**show ip pim anycast rp status**” command to check whether the configuration information of ANYCAST RP is correct

If the problems of ANYCAST still cannot be solved after checking, please use debug commands like “**debug pim anycast-rp**”, then copy the DEBUG information within three minutes and send it to the technical service center of our company.

## 48.6 PIM-SSM

### 48.6.1 Introduction to PIM-SSM

Source Specific Multicast (PIM-SSM) is a new kind of multicast service protocol. With PIM-SSM, a multicast session is distinguished by the multicast group address and multicast source address. In SSM, hosts can be added into the multicast group manually and efficiently like the traditional PIM-SM, but leave out the shared tree and RP management in PIM-SM. In SSM, SPT tree will be constructed with (S, G). G for the multicast group address and S for the source address of the multicast which sends datagram to G. (S, G) in a pair is named as a channel of SSM. SSM serves best for the application of multicast service which is from one station to many ones, for example, the network sports video channel, and the news channel. By default, the multicast group address of SSM is limited between 232.0.0.0 and 232.255.255.255. However this address range can be extended according to actual situations.

### 48.6.2 PIM-SSM Configuration Task List

Command	Explanation
Global Configuration Mode	
<b>ip multicast ssm {default range &lt;access-list-number &gt;}</b> <b>no ip multicast ssm</b>	To configure the address range for pim-ssm. The no form command will disable the configuration.

### 48.6.3 PIM-SSM Configuration Examples

As the figure shows, ethernet interfaces from SwitchA, SwitchB, SwitchC, and SwitchD are configured to be in separate VLANs. And PIM-SSM is enabled globally by enabling the PIM-SM or PIM-DM protocol on the VLAN interfaces. Take PIM-SM for example.

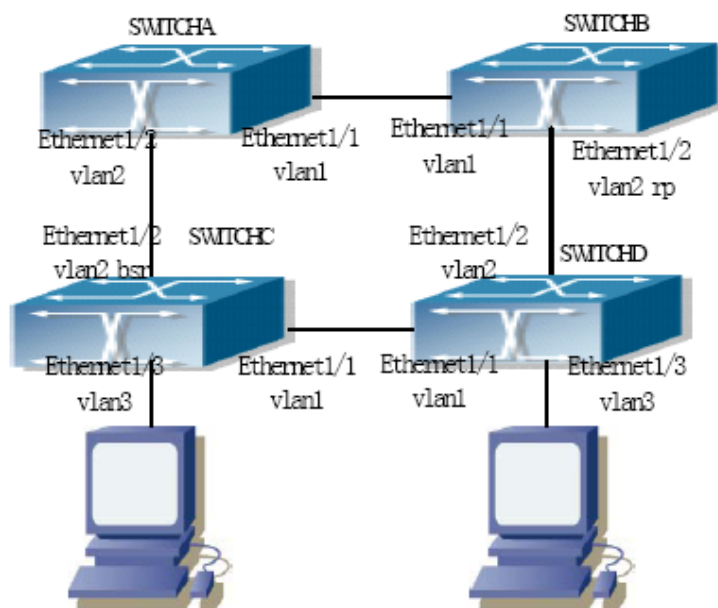

**Figure 48-7** PIM-SSM typical environment

Configurations of SwitchA, SwitchB, SwitchC, and SwitchD are shown as below.

### (1) Configuration of Switch A

```
Switch(config)#ip pim multicast-routing
Switch(config)#interface vlan 1
Switch(Config-If-Vlan1)# ip pim sparse-mode
Switch(Config-If-Vlan1)#exit
Switch(config)#interface vlan 2
Switch(Config-If-Vlan2)# ip pim sparse-mode
Switch(Config-If-Vlan2)#exit
Switch(config)#access-list 1 permit 224.1.1.1 0.0.0.255
Switch(config)#ip multicast ssm range 1
```

### (2) Configuration of Switch B

```
Switch(config)#ip pim multicast-routing
Switch(config)#interface vlan 1
Switch(Config-If-Vlan1)# ip pim sparse-mode
Switch(Config-If-Vlan1)#exit
Switch(config)#interface vlan 2
Switch(Config-If-Vlan2)# ip pim sparse-mode
Switch(Config-If-Vlan2)# exit
Switch(config)# ip pim rp-candidate vlan2
Switch(config)#access-list 1 permit 224.1.1.1 0.0.0.255
Switch(config)#ip multicast ssm range 1
```

### (3) Configuration of Switch C

```
Switch(config)#ip pim multicast-routing
Switch(config)#interface vlan 1
Switch(Config-If-Vlan1)# ip pim sparse-mode
Switch(Config-If-Vlan1)#exit
Switch(config)#interface vlan 2
Switch(Config-If-Vlan2)# ip pim sparse-mode
Switch(Config-If-Vlan2)#exit
Switch(config)#interface vlan 3
Switch(Config-If-Vlan3)# ip pim sparse-mode
Switch(Config-If-Vlan3)# exit
Switch(config)# ip pim bsr-candidate vlan2 30 10
Switch(config)#access-list 1 permit 224.1.1.1 0.0.0.255
Switch(config)#ip multicast ssm range 1
```

#### (4) Configuration of Switch D

```
Switch(config)#ip pim multicast-routing
Switch(config)#interface vlan 1
Switch(Config-If-Vlan1)# ip pim sparse-mode
Switch(Config-If-Vlan1)#exit
Switch(config)#interface vlan 2
Switch(Config-If-Vlan2)# ip pim sparse-mode
Switch(Config-If-Vlan2)#exit
Switch(config)#interface vlan 3
Switch(Config-If-Vlan3)# ip pim sparse-mode
Switch(Config-If-Vlan3)#exit
Switch(config)#access-list 1 permit 224.1.1.1 0.0.0.255
Switch(config)#ip multicast ssm range 1
```

### 48.6.4 PIM-SSM Troubleshooting

In configuring and using PIM-SSM Protocol, PIM-SSM Protocol might not operate normally caused by physical connection or incorrect configuration. Therefore, the user should pay attention to the following issues:

- Assure that physical connection is correct;
- Assure the Protocol of Interface and Link is UP (use **show interface** command);
- Assure that PIM Protocol is enabled in Global Mode (use **ip pim multicast-routing**);
- Assure that PIM-SSM is configured on the interface (use **ip pim sparse-mode**);
- Assure that SSM is configured in Global Mode;
- Multicast Protocol requires RPF check using unicast routing, therefore the correctness of unicast routing must be assured beforehand.

If all attempts including check are made but the problems on PIM-SSM can't be solved yet, then use debug



---

commands such **debug pim event/debug pim packet** please, and then copy DEBUG information in 3 minutes and send to Technology Service Center.

## 48.7 DVMRP

### 48.7.1 Introduction to DVMRP

DVMRP Protocol, namely, is “Distance Vector Multicast Routing Protocol”. It is a Multicast Routing Protocol in dense mode, which sets up a Forward Broadcast Tree for each source in a manner similar to RIP, and sets up a Truncation Broadcast Tree, i.e. the Shortest Path Tree to the source, for each source through dynamic Prune/Graft.

Some of the important features of DVMRP are:

1. The routing exchange used to determine reverse path checking information is based on distance vector (in a manner similar to RIP)
2. Routing exchange update occurs periodically (the default is 60 seconds)
3. TTL upper limit = 32 hops (and that RIP is 16)
4. Routing update includes net mask and supports CIDR

In comparison with Unicast routing, Multicast routing is a kind of reverse routing (that is, what you are interested in is where the packets are from but not where they go), thus the information in DVMRP routing table is used to determine if an input Multicast packet is received at the correct interface. Otherwise, the packet will be discarded to prevent Multicast circulation.

The check which determines if the packet gets to the correct interface is called RPF check. When some Multicast data packets get to some interface, it will determine the reverse path to the source network by looking up DVMRP router table. If the interface data packets get to is the one which is used to send Unicast message to the source, then the reverse path check is correct, and the data packets are forwarded out from all downstream interfaces. If not, then probably there is failure, and the Multicast packet is discarded.

Since not all switches support Multicast, DVMRP supports tunnel multicast communication, tunnel is a method to send multicast data report among DVMRP switches separated by switches which don't support multicast routing. Multicast data packets are encapsulated in unicast data packets and directly sent to the next switch which supports multicast. DVMRP Protocol treats tunnel interface and general physical interface equally.

If two or more switches are connected to a multi-entrance network, it is likely to transmit more than one copy of a data packet to the sub-network. Thus a specified transmitter must be appointed. DVMRP achieves this goal by making use of routing exchange mechanism; when two switches on the multi-entrance network exchange routing information, they will be aware of the routing distance from each other to the source network, thus the switch with the shortest distance to the source network will become the specified transmitter of the sub-network. If some have the same distance, then the one with the lowest IP prevails.

After some interface of the switch is configured to Function DVMRP Protocol, the switch will multicast Probe message to other DVMRP switches on this interface, which is used to find neighbors and detect the capabilities of each other. If no Probe message from the neighbor is received until the neighbor is timed out, then this neighbor is considered missing.

In DVMRP, source network routing selection message are exchanged in a basic manner same to RIP. That is, routing report message is transmitted among DVMRP neighbors periodically (the default is 60 seconds). The routing information in DVMRP routing selection table is used to set up source distribution tree, i.e. to determine by which neighbor it passes to get to the source transmitting multicast packet; the interface to this neighbor is called upstream interface. The routing report includes source network (use net mask) address and the hop entry for routing scale.

In order to finish transmission correctly, every DVMRP switch needs to know which downstream switches need to receive multicast packet from some specific source network through it. After receiving packets from some specific source, DVMRP switch firstly will broadcast these multicast packets from all downstream interfaces, i.e. the interfaces on which there are other DVMRP switches which have dependence on the specific source. After receiving Prune message from some downstream switch on the interface, it will prune this switch. DVMRP switch makes use of poison reverse to notify the upstream switch for some specific source: "I am your downstream." By adding infinity (32) to the routing distance of some specific source it broadcasts, DVMRP switch responds to the source upstream exchange to fulfill poison reverse. This means distance correct value is 1 to 2\* infinity (32) -1 or 1 to 63, 1 to 63 means it can get to source network, 32 means source network is not arrival, 33 to 63 means the switch which generates the report message will receive multicast packets from specific source depending on upstream router.

## 48.7.2 DVMRP Configuration Task List

- 1 · Globally enable and disable DVMRP (Required)
- 2 · Configure Enable and Disable DVMRP Protocol at the interface (Required)
- 3 · Configure DVMRP Sub-parameters (Optional)
  - Configure DVMRP interface parameters
    - 1) Configure the delay of transmitting report message on DVMRP interface and the message number each time it transmits
    - 2) Configure metric value of DVMRP interface
    - 3) Configure if DVMRP is able to set up neighbors with DVMRP routers which can not Prune/Graft
- 4 · Configure DVMRP tunnel

### 1. Globally enable DVMRP Protocol

The basic configuration to function DVMRP routing protocol on SGS-6341 Series Layer 3 switch is very simple. Firstly it is required to turn on DVMRP switch globally.

Command	Explanation
Global Mode	
<b>[no] ip dvmrp multicast-routing</b>	Globally enable DVMRP Protocol, the " <b>no ip dvmrp multicast-routing</b> " command disables DVMRP Protocol globally. (Required)

### 2. Enable DVMRP Protocol on the interface

The basic configuration to function DVMRP routing protocol on SGS-6341 Series Layer 3 switch is very

simple. After globally enabling DVMRP Protocol, it is required to turn on DVMRP switch under corresponding interface.

Command	Explanation
Interface Configuration Mode	
<b>ip dvmrp</b> <b>no ip dvmrp</b>	Enable DVMRP Protocol on the interface, the “ <b>no ip dvmrp</b> ” command disables DVMRP Protocol on the interface.

### 3. Configure DVMRP Sub-parameters

#### (1) Configure DVMRP Interface Parameters

- 1) Configure the delay of transmitting report message on DVMRP interface and the message number each time it transmits
- 2) Configure metric value of DVMRP interface
- 3) Configure if DVMRP is able to set up neighbors with DVMRP routers which can not Prune/Graft

Command	Explanation
Interface Configuration Mode	
<b>ip dvmrp output-report-delay</b> <b>&lt;delay_val&gt; [&lt;burst_size&gt;]</b> <b>no ip dvmrp output-report-delay</b>	Configure the delay of transmitting DVMRP report message on interface and the message number each time it transmits, the “ <b>no ip dvmrp output-report-delay</b> ” command restores default value.
<b>ip dvmrp metric &lt;metric_val&gt;</b> <b>no ip dvmrp metric</b>	Configure interface DVMRP report message metric value; the “ <b>no ip dvmrp metric</b> ” command restores default value.
<b>ip dvmrp reject-non-pruners</b> <b>no ip dvmrp reject-non-pruners</b>	Configure the interface rejects to set up neighbor relationship with non pruning/grafting DVMRP router. The “ <b>no ip dvmrp reject-non-pruners</b> ” command restores to being able to set up neighbor ship.

### 4. Configure DVMRP Tunnel

Command	Explanation
Interface Configuration Mode	
<b>ip dvmrp tunnel &lt;index&gt; &lt;src-ip&gt;</b> <b>&lt;dst-ip&gt;</b> <b>no ip dvmrp tunnel {&lt;index&gt;</b> <b>/&lt;src-ip&gt; &lt;dst-ip&gt;}</b>	This command configures a DVMRP tunnel; the “ <b>no ip dvmrp tunnel {&lt;index&gt;  &lt;src-ip&gt; &lt;dst-ip&gt;}</b> ” command deletes a DVMRP tunnel.

## 48.7.3 DVMRP Configuration Examples

As shown in the following figure, add the Ethernet interfaces of Switch A and Switch B to corresponding VLAN, and enable DVMRP on each VLAN interface.

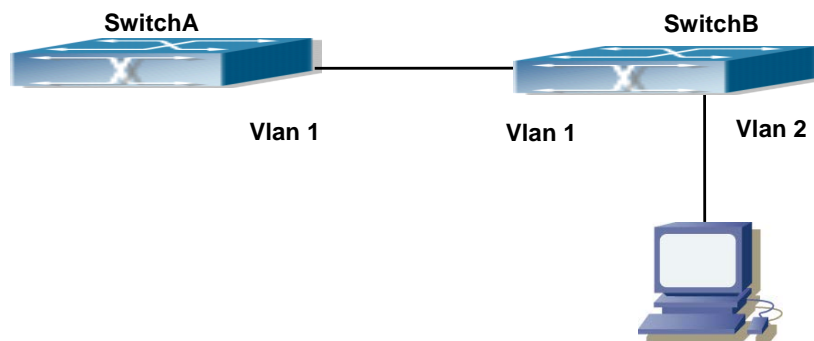

Figure 48-8 DVMRP Network Topology Diagram

The configuration procedure for SwitchA and SwitchB is as follows:

### (1) Configure SwitchA:

```
Switch (config)#ip dvmrp multicast-routing
Switch (config)#interface vlan 1
Switch(Config-if-Vlan1)# ip address 10.1.1.1 255.255.255.0
Switch(Config-if-Vlan1)# ip dvmrp enable
```

### (2) Configure SwitchB:

```
Switch (config)#ip dvmrp multicast-routing
Switch (config)#interface vlan 1
Switch(Config-if-Vlan1)# ip address 12.1.1.2 255.255.255.0
Switch(Config-if-Vlan1)# ip dvmrp enable
Switch(Config-if-Vlan1)#exit
Switch (config)#interface vlan 2
Switch(Config-if-Vlan2)# ip address 20.1.1.1 255.255.255.0
Switch(Config-if-Vlan2)# ip dvmrp
```

Since DVMRP itself does not rely on Unicast Routing Protocol, it is not necessary to configure Unicast Routing Protocol. This is the difference from PIM-DM and PIM-SM.

## 48.7.4 DVMRP Troubleshooting

In configuring and using DVMRP Protocol, DVMRP Protocol might not operate normally caused by physical connection or incorrect configuration. Therefore, the user should pay attention to the following issues:

- Firstly to assure that physical connection is correct;
- Next, to assure the Protocol of Interface and Link is UP (use **show interface** command);

- 
- Please check if the correct IP address is configured on the interface (use **ip address** command);
  - Afterwards, enable DVMRP Protocol on the interface (use **ip dvmrp** command and **ip dv multicast-routing** command);
  - Multicast Protocol requires RPF Check using unicast routing; therefore the correctness of unicast routing must be assured beforehand. (DVMRP uses its own unicast table, please use **show ip dvmrp route** command to look up).

If all attempts including Check are made but the problems on DVMRP can't be solved yet, then please use commands such as debug DVMRP, and then copy DEBUG information in 3 minutes and send to Technology Service Center.

## 48.8 DCSCM

### 48.8.1 Introduction to DCSCM

DCSCM (Destination control and source control multicast) technology mainly includes three aspects, i.e. Multicast Packet Source Controllable, Multicast User Controllable and Service-Oriented Priority Strategy Multicast.

The Multicast Packet Source Controllable technology of Security Controllable Multicast technology is mainly processed in the following manners:

- 1 · On the edge switch, if source under-control multicast is configured, then only multicast data from specified group of specified source can pass.
- 2 · For RP switch in the core of PIM-SM, for REGISTER information out of specified source and specified group, REGISTER\_STOP is transmitted directly and table entry is not allowed to set up. (This task is implemented in PIM-SM model).

The implement of Multicast User Controllable technology of Security Controllable Multicast technology is based on the control over IGMP report message sent out by the user, thus the model being controlled is IGMP snooping and IGMP model, of which the control logic includes the following three, i.e. to take control based on VLAN+MAC address transmitting packets, to take control based on IP address of transmitting packets and to take control based on the port where messages enter, in which IGMP snooping can use the above three methods to take control simultaneously, while since IGMP model is located at layer 3, it only takes control over the IP address transmitting packets .

The Service-Oriented Priority Strategy Multicast of Security Controllable technology adopts the following mode: for multicast data in limit range, set the priority specified by the user at the join-in end so that data can be sent in a higher priority on TRUNK port, consequently guarantee the transmission is processed in user-specified priority in the entire network.

## 48.8.2 DCSCM Configuration Task List

1. Source Control Configuration
2. Destination Control Configuration
3. Multicast Strategy Configuration

### 1 · Source Control Configuration

Source Control Configuration has three parts, of which the first is to enable source control. The command of source control is as follows:

Command	Explanation
Global Configuration Mode	
<b>[no] ip multicast source-control (Required)</b>	Enable source control globally, the “ <b>no ip multicast source-control</b> ” command disables source control globally. It is noticeable that, after enabling source control globally, all multicast packets are discarded by default. All source control configuration can not be processed until that it is enabled globally, while source control can not be disabled until all configured rules are disabled.

The next is to configure the rule of source control. It is configured in the same manner as for ACL, and uses ACL number of 5000-5099, every rule number can be used to configure 10 rules. It is noticeable that these rules are ordered, the front one is the one which is configured the earliest. Once the configured rules are matched, the following rules won't take effect, so rules of globally allow must be put at the end. The commands are as follows:

Command	Explanation
Global Configuration Mode	
<b>[no] access-list &lt;5000-5099&gt; {deny permit} ip {{&lt;source&gt; &lt;source-wildcard&gt;}{host-source &lt;source-host-ip&gt;} any-source} {{&lt;destination&gt; &lt;destination-wildcard&gt;}{host-destination &lt;destination-host-ip&gt;} any-destination}</b>	The rule used to configure source control. This rule does not take effect until it is applied to specified port. Using the NO form of it can delete specified rule.

The last is to configure the configured rule to specified port.

Note: If the rules being configured will occupy the table entries of hardware, configuring too many rules will result in configuration failure caused by bottom table entries being full, so we suggest user to use the simplest rules if possible. The configuration rules are as follows:

Command	Explanation
Port Configuration Mode	
<b>[no] ip multicast source-control access-group &lt;5000-5099&gt;</b>	Used to configure the rules source control uses to port, the NO form cancels the configuration.

## 2 · Destination Control Configuration

Like source control configuration, destination control configuration also has three steps.

First, enable destination control globally. Since destination control need to prevent unauthorized user from receiving multicast data, the switch won't broadcast the multicast data it received after configuring global destination control. Therefore, It should be avoided to connect two or more other Layer 3 switches in the same VLAN on a switch on which destination control is enabled. The configuration commands are as follows:

Command	Explanation
Global Configuration Mode	
<b>[no] multicast destination-control (required)</b>	Globally enable IPv4 and IPv6 destination control. The no operation of this command will globally disable destination control. All of the other configuration can only take effect after globally enabled. The next is configuring destination control rules, which are similar.

Next is to configure destination control rule. It is similar to source control, except to use ACL No. of 6000-7999.

Command	Explanation
Global Configuration Mode	
<b>[no] access-list &lt;6000-7999&gt; {deny permit} ip {{&lt;source&gt; &lt;source-wildcard&gt;}{host-source &lt;source-host-ip&gt;} any-source} {{&lt;destination&gt; &lt;destination-wildcard&gt;}{host-destination &lt;destination-host-ip&gt;} any-destination}</b>	The rule used to configure destination control. This rule does not take effect until it is applied to source IP or VLAN-MAC and port. Using the NO form of it can delete specified rule.

The last is to configure the rule to specified source IP, source VLAN MAC or specified port. It is noticeable that, due to the above situations, these rules can only be used globally in enabling IGMP-SNOOPING. And if IGMP-SNOOPING is not enabled, then only source IP rule can be used under IGMP Protocol. The configuration commands are as follows:

Command	Explanation
Port Configuration Mode	

<b>[no] ip multicast destination-control access-group &lt;6000-7999&gt;</b>	Used to configure the rules destination control uses to port, the NO form cancels the configuration.
Global Configuration Mode	
<b>[no] ip multicast destination-control &lt;1-4094&gt; &lt;macaddr&gt; access-group &lt;6000-7999&gt;</b>	Used to configure the rules destination control uses to specify VLAN-MAC, the NO form cancels the configuration.
<b>[no] ip multicast destination-control &lt;IPADDRESS/M&gt; access-group &lt;6000-7999&gt;</b>	Used to configure the rules destination control uses to specified IP address/net mask, the NO form cancels the configuration.

### 3 · Multicast Strategy Configuration

Multicast Strategy uses the manner of specifying priority for specified multicast data to achieve and guarantee the effects the specific user requires. It is noticeable that multicast data can not get a special care all along unless the data are transmitted at TRUNK port. The configuration is very simple, it has only one command, i.e. to set priority for the specified multicast. The commands are as follows:

Command	Explanation
Global Configuration Mode	
<b>[no] ip multicast policy &lt;IPADDRESS/M&gt; &lt;IPADDRESS/M&gt; cos &lt;priority&gt;</b>	Configure multicast strategy, specify priority for sources and groups in specific range, and the range is <0-7>.

## 48.8.3 DCSCM Configuration Examples

### 1 · Source Control

In order to prevent an Edge Switch from putting out multicast data ad asbitsium, we configure Edge Switch so that only the switch at port Ethernet1/5 is allowed to transmit multicast, and the data group must be 225.1.2.3. Also, switch connected up to port Ethernet1/0/10 can transmit multicast data without any limit, and we can make the following configuration.

```
EC(config)#access-list 5000 permit ip any host 225.1.2.3
EC(config)#access-list 5001 permit ip any any
EC(config)#ip multicast source-control
EC(config)#interface ethernet1/0/5
EC(Config-If-Ethernet1/0/5)#ip multicast source-control access-group 5000
EC(config)#interface ethernet1/0/10
EC(Config-If-Ethernet1/0/10)#ip multicast source-control access-group 5001
```

### 2 · Destination Control

We want to limit users with address in 10.0.0.0/8 network segment from entering the group of 238.0.0.0/8, so we can make the following configuration:



---

Firstly enable IGMP snooping in the VLAN it is located (Here it is assumed to be in VLAN2)

```
EC(config)#ip igmp snooping
EC(config)#ip igmp snooping vlan 2
```

After that, configure relative destination control access-list, and configure specified IP address to use that access-list.

```
Switch(config)#access-list 6000 deny ip any 238.0.0.0 0.255.255.255
Switch(config)#access-list 6000 permit ip any any
Switch(config)#multicast destination-control
Switch(config)#ip multicast destination-control 10.0.0.0/8 access-group 6000
```

In this way, users of this network segment can only join groups other than 238.0.0.0/8.

### 3 · Multicast strategy

Server 210.1.1.1 is distributing important multicast data on group 239.1.2.3, we can configure on its join-in switch as follows:

```
Switch(config)#ip multicast policy 210.1.1.1/32 239.1.2.3/32 cos 4
```

In this way, the multicast stream will have a priority of value 4 (Usually this is pretty higher, the higher possible one is protocol data; if higher priority is set, when there is too many multicast data, it might cause abnormal behavior of the switch protocol) when it gets to other switches through this switch.

## 48.8.4 DCSCM Troubleshooting

The effect of DCSCM module itself is similar to ACL, and the problems occurred are usually related to improper configuration. Please read the descriptions above carefully. If you still can not determine the cause of the problem, please send your configurations and the effects you expect to the after-sale service staff of our company.

## 48.9 IGMP

### 48.9.1 Introduction to IGMP

IGMP (Internet Group Management Protocol) is the protocol in TCP/IP protocol family which is responsible for IP multicast member management. It is used to set up and maintain multicast group member relationship between IP host and its neighbor multicast switches. IGMP does not include the spread and maintenance of relation information of group members among multicast switches, this work is accomplished by each multicast routing protocol. All hosts participating in multicast must implement IGMP protocol.

---

Hosts participating IP multicast can join in and exit multicast group at any location, any time and without limit of member total. Multicast switch does not need and not likely to save all relationships of all hosts. It only gets to know if there are receivers of some multicast group, i.e. group member, on the network segment each interface connects to. And the host only needs to save which multicast groups it joined.

IGMP is asymmetric between host and router: the host needs to respond the IGMP query messages of multicast switches, i.e. to report message response in membership; the switch sends out membership query messages periodically, and then determine if there are hosts of some specific group joining in the sub-network it belongs to based on the received response message, and send out query of specific group (IGMP version2) when receiving the report of a host exiting the group to determine if there exists no member in some specific group.

Up to now, there are three versions of IGMP: IGMP version1 (defined by RFC1112), IGMP version2 (defined by RFC2236) and IGMP version3 (defined by RFC3376).

The main improvements of IGMP version2 over version1 are:

1. The election mechanism of multicast switches on the shared network segment

Shared network segment is the situation of there is more than one multicast switch on a network segment. Under this kind of situation, since all switches which runs IGMP under this network segment can get membership report message from the host, therefore, only one switch is required to transmit membership query message, so an exchange election mechanism is required to determine a switch as query machine. In IGMP version1, the selection of query machine is determined by Multicast Routing Protocol; IGMP version2 made an improvement for it, it prescribed that when there are more than one multicast switches on the same network segment, the multicast switch with the lowest IP address will be elected as the query machine.

2. IGMP version2 added Leave Group Mechanism

In IGMP version 1, the host leaves the multicast group silently without sending any notification to any multicast switch. This causes that the multicast switch can only determine the leave of multicast member by multicast group response time-out. But in version2, when a host decides to leave a multicast group, if it is the host which gives response to the latest membership query message, then it will send out a message implying it is leaving.

3. IGMP version 2 added the query to specific group

In IGMP version1, a query of multicast switch is for all multicast groups on the network segment. This query is called general group query. In IGMP version2, query of specific group is added besides general group query. The destination IP address of this kind of query message is the IP address of the multicast group, the group address field part of the message is also the IP address of the multicast group. Thus it is prevented that hosts which are other multicast group members transmit response message.

4. IGMP version2 added the biggest response time field

IGMP version2 added the biggest response time field to dynamically adjust the response time of the host to group query message.

The main features of version3 is allowing the host to choose receiving from or rejecting a certain source, which is the basis of SSM (Source-Specific Multicast) multicast. For example, when a host is sending a report of INCLUDE{10.1.1.1, 10.1.1.2} to some group G, that means the host needs the router to forward the

flux from 10.1.1.1 and 10.1.1.2; when a host is sending a report of EXCLUDE{192.168.1.1} to some group G, that means the host needs the flux from all sources of group G except 192.168.1.1. This makes a great difference from the previous IGMP.

The main improvements of IGMP Version3 over IGMP Version1 and Version2 are:

1. The status to be maintained is group and source list, not only the groups in IGMPv2.
2. The interoperations with IGMPv1 and IGMPv2 are defined in IGMPv3 status.
3. IP service interface is modified to allow specific source list thereby.
4. The queried includes his/her Robustness Variable and Query Interval in query group to allow the synchronization with these variables of non-queries.
5. Max Response Time in Query Message has an exponential range, with maximum value from 25.5 secs of v2 to 53 mins, which can be used in links of great capacity.
6. In order to increase strength, the host retransmits State-Change message.
7. Additional data is defined to adapt future extension.
8. Report group is sent to 224.0.0.22 to help with IGMP Snooping of Layer 2 Switch.
9. Report group can include more than one group record, and it allows using small group to report complete current status.
10. The host does not restrain operation any more, which simplifies the implement and allows direct membership trace.
11. In querying messages, the new router side restraint process (S sign) modified the existing strength of IGMPv2.

## 48.9.2 IGMP Configuration Task List

- 1 · Enable IGMP (Required)
- 2 · Configure IGMP sub-parameters (Optional)
  - (1) Configure IGMP group parameters
    - 1) Configure IGMP group filtering conditions
    - 2) Configure IGMP to join in group
    - 3) Configure IGMP to join in static group
  - (2) Configure IGMP query parameters
    - 1) Configure the interval of IGMP sending query message
    - 2) Configure the maximum response time of IGMP query
    - 3) Configure time-out of IGMP query
  - (3) Configure IGMP version
- 3 · Disable IGMP Protocol

### 1. Enable IGMP Protocol

There are not specific commands for enabling IGMP Protocol on the Layer 3 switch. Enabling any multicast protocol under corresponding interface will automatically enable IGMP.

Command	Explanation
Global Mode	

<b>ip dvmrp multicast-routing   ip pim multicast-routing</b>	To enable global multicast protocol is the prerequisite to enable IGMP protocol, the “ <b>no ip dvmrp multicast-routing   no ip pim multicast-routing</b> ” commands disable multicast protocol and IGMP protocol. (Required)
--	---

Command	Explanation
Interface Configuration Mode	
<b>ip dvmrp enable   ip pim dense-mode   ip pim sparse-mode</b>	Enable IGMP Protocol, the corresponding commands “ <b>no ip dvmrp enable   no ip pim dense-mode   no ip pim sparse-mode</b> ” disable IGMP Protocol. (Required)

## 2. Configure IGMP Sub-parameters

### (1) Configure IGMP group parameters

- 1) Configure IGMP group filtering conditions
- 2) Configure IGMP to join in group
- 3) Configure IGMP to join in static group

Command	Explanation
Interface Configuration Mode	
<b>ip igmp access-group {&lt;acl_num / acl_name&gt;} no ip igmp access-group</b>	Configure the filtering conditions of the interface to IGMP group; the “ <b>no ip igmp access-group</b> ” command cancels the filtering condition.
<b>ip igmp join-group &lt;A.B.C.D&gt; no ip igmp join-group &lt;A.B.C.D &gt;</b>	Configure the interface to join in some IGMP group, the “ <b>no ip igmp join-group &lt;A.B.C.D &gt;</b> ” command cancels the join.
<b>ip igmp static-group &lt;A.B.C.D&gt; no ip igmp static-group &lt;A.B.C.D&gt;</b>	Configure the interface to join in some IGMP static group; the “ <b>no ip igmp static-group &lt;A.B.C.D &gt;</b> ” command cancels the join.

### (2) Configure IGMP Query parameters

- 1) Configure interval for IGMP to send query messages
- 2) Configure the maximum response time of IGMP query
- 3) Configure the time-out of IGMP query

Command	Explanation
Interface Configuration Mode	
<b>ip igmp query-interval &lt;time_val&gt; no ip igmp query-interval</b>	Configure the interval of IGMP query messages sent periodically; the “ <b>no ip igmp query-interval</b> ” command restores default value.

<b>ip igmp query-max-response-time &lt;time_val&gt;</b> <b>no ip igmp query-max-response-time</b>	Configure the maximum response time of the interface for IGMP query; the “ <b>no ip igmp query-max-response-time</b> ” command restores default value.
<b>ip igmp query-timeout &lt;time_val&gt;</b> <b>no ip igmp query-timeout</b>	Configure the time-out of the interface for IGMP query; the “ <b>no ip igmp query-timeout</b> ” command restores default value.

### (3) Config IGMP version

Command	Explanation
Global Mode	
<b>ip igmp version &lt;version&gt;</b> <b>no ip igmp version</b>	Configure IGMP version on the interface; the “ <b>no ip igmp version</b> ” command restores the default value.

### 3. Disable IGMP Protocol

Command	Explanation
Interface Configuration Mode	
<b>no ip dvmrp   no ip pim dense-mode   no ip pim sparse-mode   no ip dvmrp multicast-routing   no ip pim multicast-routing</b>	Disable IGMP Protocol.

## 48.9.3 IGMP Configuration Examples

As shown in the following figure, add the Ethernet ports of Switch A and Switch B to corresponding VLAN, and start PIM-DM on each VLAN interface.

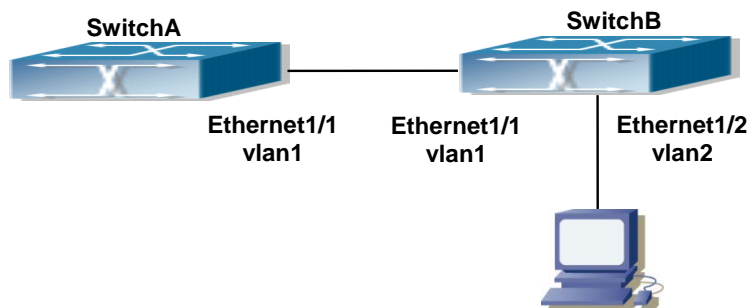

Figure 48-9 IGMP Network Topology Diagram

The configuration procedure for SwitchA and SwitchB is as follows:

---

### (1) Configure SwitchA:

```
Switch(config)#ip pim multicast-routing
Switch (config)#interface vlan 1
Switch(Config-if-Vlan1)#ip address 12.1.1.1 255.255.255.0
Switch(Config-if-Vlan1)#ip pim dense-mode
```

### (2) Configure SwitchB:

```
Switch(config)#ip pim multicast-routing
Switch(config)#interface vlan1
Switch(Config-if-Vlan1)#ip address 12.1.1.2 255.255.255.0
Switch(Config-if-Vlan1)#ip pim dense-mode
Switch(Config-if-Vlan1)#exit
Switch(config)#interface vlan2
Switch(Config-if-Vlan1)#ip address 20.1.1.1 255.255.255.0
Switch(Config-if-Vlan2)#ip pim dense-mode
Switch(Config-if-Vlan2)#ip igmp version 3
```

## 48.9.4 IGMP Troubleshooting

In configuring and using IGMP Protocol, IGMP Protocol might not operate normally caused by physical connection or incorrect configuration. Therefore, user should pay attention to the following issues:

- Firstly to assure that physical connection is correct;
- Next, to assure the Protocol of Interface and Link protocol is UP (use show interface command);
- Afterwards, to assure to start a kind of multicast protocol on the interface;
- Multicast Protocol requires RPF Check using unicast routing; therefore the correctness of unicast routing must be assured beforehand.

## 48.10 IGMP Snooping

### 48.10.1 Introduction to IGMP Snooping

IGMP (Internet Group Management Protocol) is a protocol used in IP multicast. IGMP is used by multicast enabled network device (such as a router) for host membership query, and by hosts that are joining a multicast group to inform the router to accept packets of a certain multicast address. All those operations are done through IGMP message exchange. The router will use a multicast address (224.0.0.1) that can address to all hosts to send an IGMP host membership query message. If a host wants to join a multicast group, it will reply to the multicast address of that a multicast group with an IGMP host membership reports a message.

IGMP Snooping is also referred to as IGMP listening. The switch prevents multicast traffic from flooding through IGMP Snooping, multicast traffic is forwarded to ports associated to multicast devices only. The switch listens to the IGMP messages between the multicast router and hosts, and maintains multicast group

forwarding table based on the listening result, and can then decide to forward multicast packets according to the forwarding table.

Switch provides IGMP Snooping and is able to send a query from the switch so that the user can use switch in IP multicast.

## 48.10.2 IGMP Snooping Configuration Task List

1. Enable IGMP Snooping
2. Configure IGMP Snooping

### 1. Enable IGMP Snooping

Command	Explanation
Global Mode	
<b>ip igmp snooping</b> <b>no ip igmp snooping</b>	Enables IGMP Snooping. The no operation disables IGMP Snooping function.

### 2. Configure IGMP Snooping

Command	Explanation
Global Mode	
<b>ip igmp snooping vlan &lt;vlan-id&gt;</b> <b>no ip igmp snooping vlan &lt;vlan-id&gt;</b>	Enables IGMP Snooping for specified VLAN. The no operation disables IGMP Snooping for specified VLAN.
<b>ip igmp snooping proxy</b> <b>no ip igmp snooping proxy</b>	Enable IGMP Snooping proxy function, the no command disables the function.
<b>ip igmp snooping vlan &lt; vlan-id &gt; limit</b> <b>{group &lt;g_limit&gt;   source &lt;s_limit&gt;}</b> <b>no ip igmp snooping vlan &lt; vlan-id &gt; limit</b>	Configure the max group count of vlan and the max source count of every group. The “ <b>no ip igmp snooping vlan &lt;vlan-id&gt; limit</b> ” command cancels this configuration.
<b>ip igmp snooping vlan &lt;vlan-id&gt;</b> <b>l2-general-querier</b> <b>no ip igmp snooping vlan &lt;vlan-id&gt;</b> <b>l2-general-querier</b>	Set this vlan to layer 2 general querier. It is recommended to configure a layer 2 general querier on a segment. The “ <b>no ip igmp snooping vlan &lt;vlan-id&gt; l2-general-querier</b> ”command cancels this configuration.
<b>ip igmp snooping vlan &lt;vlan-id&gt;</b> <b>l2-general-querier-version &lt;version&gt;</b>	Configure the version number of a general query from a layer 2 general querier.
<b>ip igmp snooping vlan &lt;vlan-id&gt;</b> <b>l2-general-querier-source &lt;source&gt;</b>	Configure the source address of a general query from a layer 2 general querier.
<b>ip igmp snooping vlan &lt;vlan-id&gt;</b>	Configure static mrouter port of vlan. The no

<pre>mrouter-port interface &lt;interface -name&gt; no ip igmp snooping vlan &lt;vlan-id&gt; mrouter-port interface &lt;interface -name&gt;</pre>	<p>form of the command cancels this configuration.</p>
<pre>ip igmp snooping vlan &lt;vlan-id&gt; mrouter-port learnpim no ip igmp snooping vlan &lt;vlan-id&gt; mrouter-port learnpim</pre>	<p>Enable the function that the specified VLAN learns mrouter-port (according to pim packets), the no command will disable the function.</p>
<pre>ip igmp snooping vlan &lt;vlan-id&gt; mrpt &lt;value &gt; no ip igmp snooping vlan &lt;vlan-id&gt; mrpt</pre>	<p>Configure this survive time of mrouter port. The “no ip igmp snooping vlan &lt;vlan-id&gt; mrpt” command restores the default value.</p>
<pre>ip igmp snooping vlan &lt;vlan-id&gt; query-interval &lt;value&gt; no ip igmp snooping vlan &lt;vlan-id&gt; query-interval</pre>	<p>Configure this query interval. The “no ip igmp snooping vlan &lt;vlan-id&gt; query-interval” command restores the default value.</p>
<pre>ip igmp snooping vlan &lt;vlan-id&gt; immediately-leave no ip igmp snooping vlan &lt;vlan-id&gt; immediately-leave</pre>	<p>Enable the IGMP fast leave function for the specified VLAN: the “no ip igmp snooping vlan &lt;vlan-id&gt; immediate-leave” command disables the IGMP fast leave function.</p>
<pre>ip igmp snooping vlan &lt;vlan-id&gt; query-mrsp &lt;value&gt; no ip igmp snooping vlan &lt;vlan-id&gt; query-mrsp</pre>	<p>Configure the maximum query response period. The “no ip igmp snooping vlan &lt;vlan-id&gt; query-mrsp” command restores to the default value.</p>
<pre>ip igmp snooping vlan &lt;vlan-id&gt; query-robustness &lt;value&gt; no ip igmp snooping vlan &lt;vlan-id&gt; query-robustness</pre>	<p>Configure the query robustness. The “no ip igmp snooping vlan &lt;vlan-id&gt; query-robustness” command restores to the default value.</p>
<pre>ip igmp snooping vlan &lt;vlan-id&gt; suppression-query-time &lt;value&gt; no ip igmp snooping vlan &lt;vlan-id&gt; suppression-query-time</pre>	<p>Configure the suppression query time. The “no ip igmp snooping vlan &lt;vlan-id&gt; suppression-query-time” command restores to the default value.</p>
<pre>ip igmp snooping vlan &lt;vlan-id&gt; static-group &lt;A.B.C.D&gt; [source &lt;A.B.C.D&gt;] interface [ethernet   port-channel] &lt;IFNAME&gt; no ip igmp snooping vlan &lt;vlan-id&gt; static-group &lt;A.B.C.D&gt; [source &lt;A.B.C.D&gt;] interface [ethernet   port-channel] &lt;IFNAME&gt;</pre>	<p>Configure static-group on specified port of the VLAN. The no form of the command cancels this configuration.</p>
<pre>ip igmp snooping vlan &lt;vlan-id&gt; report</pre>	<p>Configure forwarding IGMP packet source</p>



<pre>source-address &lt;A.B.C.D&gt; no ip igmp snooping vlan &lt;vlan-id&gt; report source-address</pre>	<p>address, The no operation cancels the packet source address.</p>
<pre>ip igmp snooping vlan &lt;vlan-id&gt; specific-query-mrsp &lt;value&gt; no ip igmp snooping vlan &lt;vlan-id&gt; specific-query-mrspt</pre>	<p>Configure the maximum query response time of the specific group or source, the no command restores the default value.</p>

### 48.10.3 IGMP Snooping Examples

#### Scenario 1: IGMP Snooping function

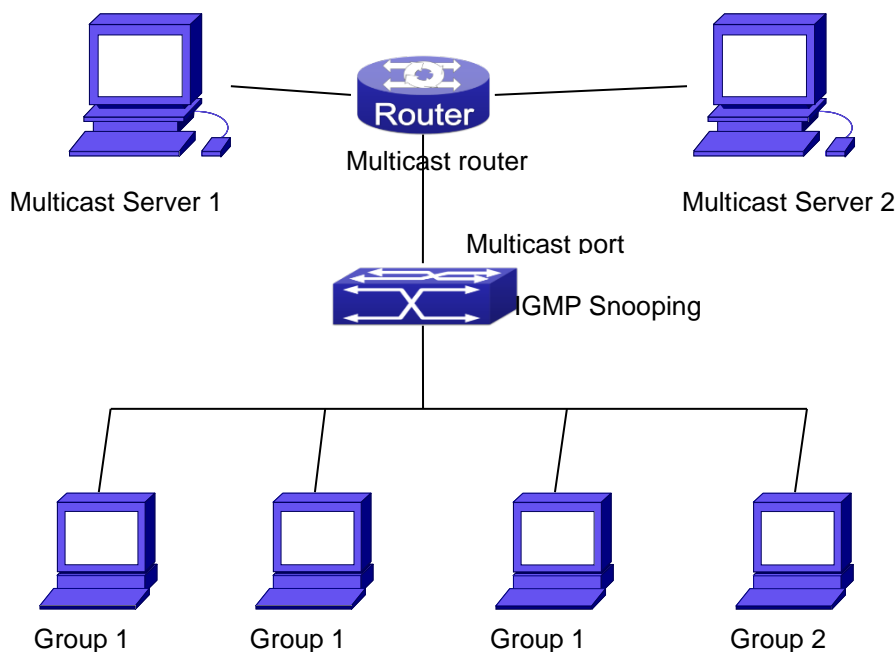

**Figure 48-10** Enabling IGMP Snooping function

Example: As shown in the above figure, a VLAN 100 is configured in the switch and includes ports 1, 2, 6, 10 and 12. Four hosts are connected to port 2, 6, 10, 12 respectively and the multicast router is connected to port 1. As IGMP Snooping is disabled by default either in the switch or in the VLANs, If IGMP Snooping should be enabled in VLAN 100, the IGMP Snooping should be first enabled for the switch in Global Mode and in VLAN 100 and set port 1 of VLAN 100 to be the mrouter port.

The configuration steps are listed below:

```
Switch(config)#ip igmp snooping
Switch(config)#ip igmp snooping vlan 100
Switch(config)#ip igmp snooping vlan 100 mrouter interface ethernet 1/1
```

#### Multicast Configuration

Suppose two programs are provided in the Multicast Server using multicast address Group1 and Group2,

three of four hosts running multicast applications are connected to port 2, 6, 10 plays program1, while the host is connected to port 12 plays program 2.

**IGMP Snooping listening result:**

The multicast table built by IGMP Snooping in VLAN 100 indicates ports 1, 2, 6, 10 in Group1 and ports 1, 12 in Group2.

All the four hosts can receive the program of their choice: ports 2, 6, 10 will not receive the traffic of program 2 and port 12 will not receive the traffic of program 1.

**Scenario 2: L2-general-querier**

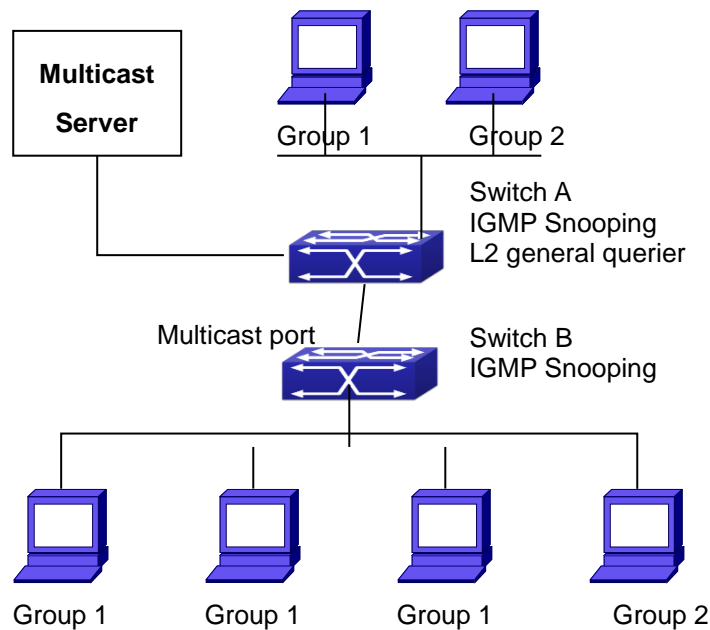

**Figure 48-11** The switches as IGMP Queries

The configuration of Switch2 is the same as the switch in scenario 1, SwitchA takes the place of Multicast Router in scenario 1. Let's assume VLAN 60 is configured in SwitchA, including ports 1, 2, 6, 10 and 12. Port 1 connects to the multicast server, and port 2 connects to Switch2. In order to send Query at regular interval, IGMP query must enabled in Global mode and in VLAN60.

The configuration steps are listed below:

```
SwitchA#config
SwitchA(config)#ip igmp snooping
SwitchA(config)#ip igmp snooping vlan 60
SwitchA(config)#ip igmp snooping vlan 60 L2-general-querier

SwitchB#config
SwitchB(config)#ip igmp snooping
SwitchB(config)#ip igmp snooping vlan 100
SwitchB(config)#ip igmp snooping vlan 100 mrouter interface ethernet 1/0/1
```

---

## Multicast Configuration

The same as scenario 1

### IGMP Snooping listening result:

Similar to scenario 1

**Scenario 3:** To run in cooperation with layer 3 multicast protocols.

SWITCH which is used in Scenario 1 is replaced with ROUTER with specific configurations remains the same. And multicast and IGMP snooping configurations are the same with what it is in Scenario 1. To configure PIM-SM on ROUTER, and enable PIM-SM on vlan 100 (use the same PIM mode with the connected multicast router)

Configurations are listed as below:

```
switch#config
switch(config)#ip pim multicast-routing
switch(config)#interface vlan 100
switch(config-if-vlan100)#ip pim sparse-mode
```

IGMP snooping does not distribute entries when layer 3 multicast protocol is enabled. It only does the following tasks.

- Remove the layer 2 multicast entries.
- Provide query functions to the layer 3 with vlan, S, and G as the parameters.
- When layer 3 IGMP is disabled, re-enable distributing layer 2 multicast entries.

By looking up the layer 3 IPMC entries, it can be found that ports can be indicated by the layer 3 multicast entries. This ensures the IGMP snooping can work in cooperation with the layer 3 multicast protocols.

## 48.10.4 IGMP Snooping Troubleshooting

On IGMP Snooping function configuration and usage, IGMP Snooping might not run properly because of physical connection or configuration mistakes. So the users should note that:

- Make sure correct physical connection
- Activate IGMP Snooping on whole configuration mode (use **ip igmp snooping**)
- Configure IGMP Snooping at VLAN on whole configuration mode (use **ip igmp snooping vlan <vlan-id>**)
- Make sure one VLAN is configured as L2 common checker in same mask, or make sure configured static mrouter
- Use **show ip igmp snooping vlan <vid>** command check IGMP Snooping information

---

## 48.11 IGMP Proxy Configuration

### 48.11.1 Introduction to IGMP Proxy

IGMP/MLD proxy which is introduced in rfc4605, is a simplified multicast protocol running at edge boxes. The edge boxes which runs the IGMP/MLD proxy protocol, does not need to run complicated multicast routing protocols such as PIM/DVMRP. However they work with multicast protocol enabled network through IGMP/MLD proxy. They can simplify the implementation of multicasting on edge devices.

The IGMP/MLD proxy works between the multicast router and the client, it works as both the multicast host and router. Upstream and downstream ports should be specified in the IGMP/MLD proxy configuration. The host protocol runs at upstream ports, while the router protocol runs at downstream ports. The switch collects the join and leave messages received from downstream ports and forward them to the multicast router through upstream ports.

The IGMP proxy configuration is exclusive with PIM and DVMRP configuration.

### 48.11.2 IGMP Proxy Configuration Task List

- 1 · Enable IGMP Proxy function
- 2 · Enable configurations for both downstream and upstream ports for the IGMP Proxy in different interfaces
- 3 · Configure IGMP Proxy

#### 1. Enable IGMP Proxy function

Command	Explanation
Global Mode	
<b>ip igmp proxy</b> <b>no ip igmp proxy</b>	Enable IGMP Proxy function. The “ <b>no ip igmp proxy</b> ” disables this function.

#### 2. Enable configurations for both downstream and upstream ports for the IGMP Proxy in different interfaces

Command	Explanation
Interface Configuration Mode	
<b>ip igmp proxy upstream</b> <b>no ip igmp proxy upstream</b>	Enable IGMP Proxy upstream function. The “ <b>no ip igmp proxy upstream</b> ” disables this function.
<b>ip igmp proxy downstream</b> <b>no ip igmp proxy downstream</b>	Enable IGMP Proxy downstream function. The “ <b>no ip igmp proxy downstream</b> ” disables this function.

### 3. Configure IGMP Proxy assistant parameter

Command	Explanation
Global Mode	
<b>ip igmp proxy limit {group &lt;1-500&gt;  source &lt;1-500&gt;}</b> <b>no ip igmp proxy limit</b>	To configure the maximum number of groups that upstream ports can join, and the maximum number of sources in a single group. The no form of this command will restore the default value.
<b>ip igmp proxy unsolicited-report interval &lt;1-5&gt;</b> <b>no ip igmp proxy unsolicited-report interval</b>	To configure how often the upstream ports send out unsolicited report. The no form of this command will restore the default configuration.
<b>ip igmp proxy unsolicited-report robustness &lt;2-10&gt;</b> <b>no ip igmp proxy unsolicited-report robustness</b>	To configure the retry times of upstream ports' sending unsolicited reports. The no form of this command will restore the default value.
<b>ip igmp proxy aggregate</b> <b>no ip igmp proxy aggregate</b>	To configure non-query downstream ports to be able to aggregate the IGMP operations. The no form of this command will restore the default configuration.
<b>ip multicast ssm range &lt;1-99&gt;</b> <b>ip multicast ssm default</b> <b>no ip mulitcast ssm</b>	To configure the address range for IGMP proxy ssm multicast groups; The no form of this command will remove the configuration.
<b>ip igmp proxy multicast-source</b> <b>no ip igmp proxy multicast-source</b>	To configure the port as downstream ports for the source of multicast datagram; The no from of this command will disable the configuration.

## 48.11.3 IGMP Proxy Examples

**Example 1:** IGMP Proxy function.

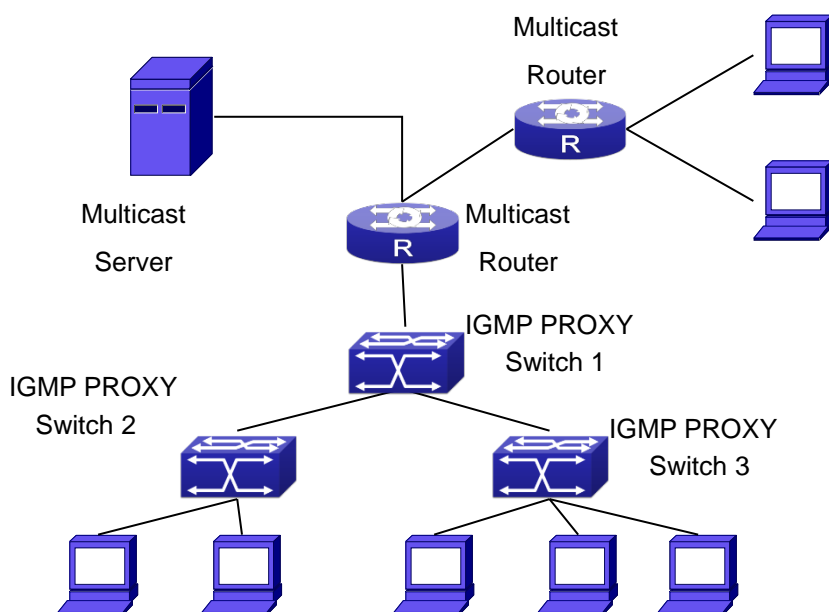

**Figure 48-12** IGMP Proxy Topology Diagram

As it is show in the figure above, the switch functions as IGMP Proxy in a network of topology of tree, the switch aggregates the multicast dataflow from upstream port and redistributes them to the downstream ports, while the IGMP membership reports flow from downstream ports to upstream ports. Three IGMP Proxy enabled switches which are connected in tree topology, respectively have one port connected to multicast routers, and no less than one ports connected to hosts or upstream ports from other IGMP Proxy enabled switches.

**The configuration steps are listed below:**

```
Switch#config
Switch(config)#ip igmp proxy
Switch(Config)#interface vlan 1
Switch(Config-if-Vlan1)#ip igmp proxy upstream
Switch(Config)#interface vlan 2
Switch(Config-if-Vlan2)#ip igmp proxy downstream
```

### **Multicast Configuration:**

Suppose the multicast server offers some programs through 224.1.1.1. Some hosts subscribe that program at the edge of the network. The IGMP multicast members report themselves to the downstream ports of IGMP Proxy enabled Switch 2 and Switch 3. Switch 2 and Switch 3 then aggregate the group membership information and send them through the upstream ports. Switch 1 finally forward these membership information to the multicast router when receiving the group membership information through upstream ports, and deliver the multicast dataflow through downstream ports.

**Example2:** IGMP Proxy for multicast sources from downstream ports.

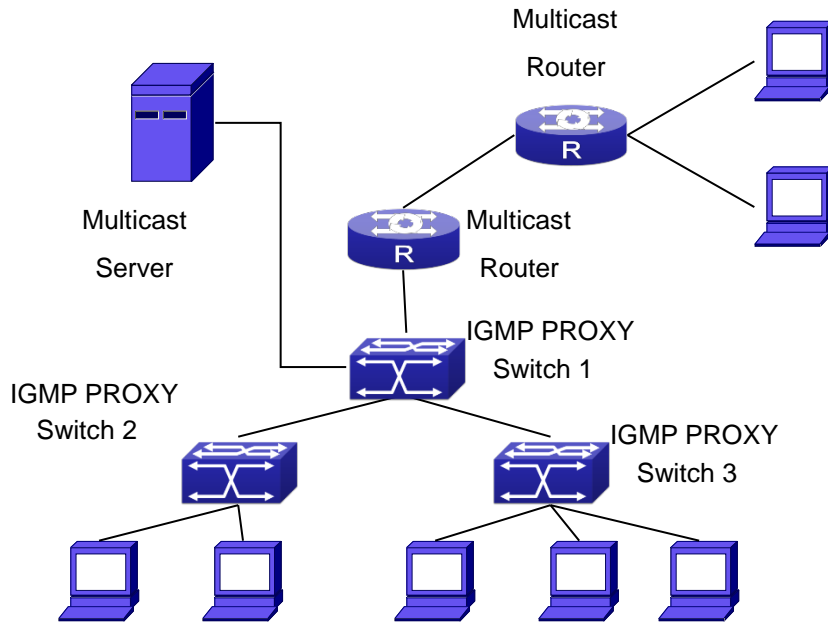

**Figure 48-13** IGMP Proxy for multicast sources from downstream ports

As it is show in the figure above, IGMP Proxy enabled switches connected to the network in tree topology. The multicast source server connects to the downstream port of Switch1, the multicast dataflow is distributed through the upstream port and other downstream ports. Three IGMP Proxy enabled switches which are connected in tree topology, respectively have one port connected to multicast routers, and no less than one ports connected to hosts or upstream ports from other IGMP proxy enabled switches.

**The configuration steps are listed below:**

IGMP PROXY Switch1 configuration :

```
Switch#config
Switch(config)#ip igmp proxy
Switch(Config)#interface vlan 1
Switch(Config-if-Vlan1)#ip igmp proxy upstream
Switch(Config)#interface vlan 2
Switch(Config-if-Vlan2)#ip igmp proxy downstream
Switch(Config-if-Vlan2)#ip igmp proxy multicast-source
```

Route1 configuration:

```
Switch#config
Switch(config)#ip pim multicast
Switch(Config)#interface vlan 1
Switch(Config-if-Vlan1)#ip pim sparse-mode
Switch(Config-if-Vlan1)#ip pim bsr-border
```

---

### **Multicast Configuration:**

Suppose the server provides programs through the multicast address 224.1.1.1, and some hosts subscribe that program on the edge of the network. The host reports their IGMP multicast group membership to Switch 2 and Switch 3 through downstream ports. Switch 2 and Switch 3 then aggregate and forward them to Switch 1 which then forwards the information to multicast router. When multicast dataflow arrives, the IGMP Proxy enabled switches re-distribute the group membership through upstream ports and downstream ports. When the multicast router receives the multicast dataflow from IGMP proxy, it will consider the multicast data source is directly connected to the router, and determine the identity of DR and ORIGINATOR. The multicast dataflow will be redistributed according to the PIM protocol.

## **48.11.4 IGMP Proxy Troubleshooting**

When IGMP Proxy function configuration and usage, IGMP Proxy might not run properly because of physical connection or configuration mistakes. So the users should note that:

- Make sure physical connection correctly;
- Activate IGMP Proxy on whole Global mode (use **ip igmp proxy**);
- Make sure configure one upstream port and at least one downstream port under interface configuration mode (Use **ip igmp proxy upstream, ip igmp proxy downstream**);
- Use **show ip igmp proxy** command to check if the IGMP Proxy information is correct.

If the IGMP Proxy problem remains unsolved, please use debug IGMP Proxy and other debugging command and copy the DEBUG message within three minutes, send the recorded message to the technical service center of our company.



---

# Chapter 49 IPv6 Multicast Protocol

## 49.1 PIM-DM6

### 49.1.1 Introduction to PIM-DM6

PIM-DM6 (Protocol Independent Multicast, Dense Mode) is the IPv6 version of Protocol Independent Multicast Dense Mode. It is a Multicast Routing Protocol in dense mode which adapted to small network. The members of multicast group are relatively dense under this kind of network environment. There is no difference compared with the IPv4 version PIM-DM except that the addresses it uses are IPv6 addresses. Thus we don't differentiate between PIM-DM and PIM-DM6 in this chapter. All PIM-DM in the text without specific explanation refers to IPv6 version PIM-DM.

As a result of continuous development of IPv6 network, it has the network environment of nonsupport IPv6 multicast sometimes, so it needs to do the IPv6 multicast operation by tunnel. Therefore, our PIM-DM6 supports configuration on configure tunnel, and passes through nonsupport IPv6 multicast network by single cast packet of IPv4 encapsulation.

The working process of PIM-DM can be summarized as: Neighbor Discovery, Flooding-Prune, and Graft.

#### 1. Neighbor Discovery

When PIM-DM router is started at beginning, Hello message is required to discover neighbors. The network nodes running PIM-DM use Hello message to contact each other. PIM-DM Hello message is sent periodically.

#### 2. Flooding-Prune

PIM-DM assumes that all hosts on the network are ready to receive multicast data. When certain multicast source S begins to send data to a multicast group G, after receiving the multicast packet, the router will make RPF examination first according to the unicast table. If the check passes, the router will create a (S, G) table item and forward the multicast packet to all downstream PIM-DM nodes (Flooding). If the RPF examination fails, i.e. the multicast packet is inputted from the incorrect interface, and then the message is discarded. After this procedure, every node will create an (S, G) item in the PIM-DM multicast domain. If there is no multicast group member in the downstream nodes, then a Prune message is sent to upstream nodes notifying not to forward data to this multicast group any more. After receiving Prune message, the corresponding interfaces will be deleted from the output interface list corresponding with the multicast-forwarding item (S, G). Through this process, a SPT (Shortest Path Tree) is established with source S as root. Prune process is started by a sub-router.

The process above is called Flooding-Prune process. Each pruned node also provides overtime mechanism at the same time. In case of overtime of prune, the router will restart flooding-prune process. Flooding-prune of PIM-DM is conducted periodically

#### 3. RPF examination

Adopting RPF examination, PIM-DM establishes a multicast forwarding tree initiating from data source, using existing unicast routing table. When a multicast packet arrives, the router will determine the correctness of its coming path first. If the arrival interface is the interface connected to multicast source indicated by unicast routing, then this multicast packet is considered to be from the correct path; otherwise

the multicast packet will be discarded as redundant message. The unicast routing message used as path judgment can root in any Unicast Routing Protocol, such as messages found by RIP, OSPF, etc. It doesn't rely on any specific unicast routing protocol.

#### 4. Assert Mechanism

If two multicast router A and B in the same LAN segment have their own receiving paths to multicast source S, they will respectively forward multicast data packet to LAN after receiving the packet from multicast source S. Then downstream nodes multicast router C will receive two multicast packets that are exactly the same. Once router detects such circumstance, a unique forwarder will be selected through "assert" mechanism. The optimized forwarding path is selected through "assert" packet. If the priority and costs of two or more than two paths are same, the node with a larger IP address will be selected as the upstream neighbor of item (S, G), which will be responsible for forwarding the (S, G) multicast packet.

#### 5. Graft

When the pruned downstream node needs to recover to forwarding status, this node uses Graft Message to notify upstream nodes to resume multicast data forwarding.

### 49.1.2 PIM-DM6 Configuration Task List

- 1 · Enable PIM-DM (Required)
- 2 · Configure static multicast routing entries (Optional)
- 3 · Configure additional PIM-DM parameters (Optional)
  - (1) Configure parameters for PIM-DM interfaces
    - 1) Configure the interval for PIM-DM hello messages
    - 2) Configure the interval for PIM-DM state-refresh messages
    - 3) Configure the boundary interfaces
    - 4) Configure the management boundary
- 4 · Disable PIM-DM protocol

#### 1. Enable the PIM-DM protocol

On SGS-6341 Series switches, PIM-DM can be enabled through two steps. Firstly PIM multicast routing should be enabled in global configuration mode, then PIM-DM should be configured for the specific interfaces.

Command	Explanation
Command configuration mode	
<b>ipv6 pim multicast-routing</b>	To enable PIM-DM multicast routing global. However, in order to enable PIM-DM for specific interfaces, the following command must be issued.

Enable PIM-SM for the specific interface:

Command	Explanation
Interface configuration mode	

<b>ipv6 pim dense-mode</b>	To enable PIM-DM for the specified interface (required).
----------------------------	--

## 2 · Configure static multicast routing entries

Command	Explanation
Global configuration mode	
<b>ipv6 mroute &lt;X:X::X:X&gt; &lt;X:X::X:X&gt; &lt;ifname&gt; &lt;ifname&gt; no ipv6 mroute &lt;X:X::X:X&gt; &lt;X:X::X:X&gt; [&lt;ifname&gt; &lt;ifname&gt;]</b>	To configure IPv6 static multicast routing entries. The no form of this command will remove the specified routing entry.

## 3. Configure additional PIM-DM parameters

### (1) Configure parameters for PIM-DM interfaces

#### 1) Configure the interval for PIM-DM hello messages

Command	Explanation
Interface Configuration Mode	
<b>ipv6 pim hello-interval &lt;interval&gt; no ipv6 pim hello-interval</b>	To configure the interval for PIM-DM hello messages. The no form of this command will restore the default value.

#### 2) Configure the interval for PIM-DM state-refresh messages

Command	Explanation
Interface Configuration Mode	
<b>ipv6 pim state-refresh origination-interval no ipv6 pim state-refresh origination-interval</b>	To configure the interval for sending PIM-DM state-refresh packets. The no form of this command will restore the default value.

#### 3) Configure the boundary interfaces

Command	Explanation
Interface Configuration Mode	
<b>ipv6 pim bsr-border no ipv6 pim bsr-border</b>	To configure the interface as the boundary of PIM-DM6 protocol. On the boundary interface, STATE REFRESH messages will not be sent or received. The network connected the interface is considered as directly connected network. The no form of this command will remove the configuration.

4) Configure the management boundary

Command	Explanation
Interface Configuration Mode	
<b>ipv6 pim scope-border</b> <b>&lt;500-599&gt; &lt;acl_name&gt;</b> <b>no ipv6 pim scope-border</b>	To configure PIM-DM6 management boundary for the interface and apply ACL for the management boundary. With default settings, ffx0::/13 is considered as the scope of the management group. If ACL is configured, then the scope specified by ACL permit command is the scope of the management group. acl_name should be standard IPv6 ACL name. The no form of this command will remove the configuration.

4. Disable PIM-DM protocol

Command	Notes
Interface Configuration Mode	
<b>no ipv6 pim dense-mode</b>	To disable PIM-DM for the specified interface.
Global Configuration Mode	
<b>no ipv6 pim multicast-routing</b>	To disable PIM-DM globally.

### 49.1.3 PIM-DM6 Typical Application

As shown in the following figure, add the Ethernet interfaces of Switch A and Switch B to corresponding vlan, and start PIM-DM Protocol on each vlan interface.

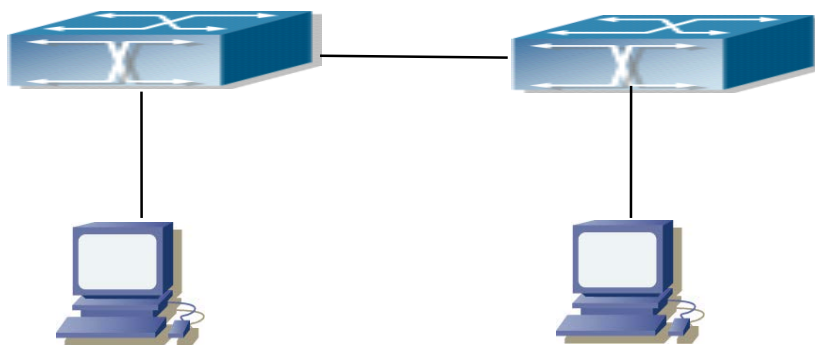

Figure 49-1 PIM-DM Typical Environment

The configuration procedure for SwitchA and SwitchB is as below:

### (1) Configure SwitchA:

```
Switch(config)#ipv6 pim multicast-routing
Switch(config)#interface vlan 1
Switch(Config-if-Vlan1)#ipv6 address 2000:10:1:1::1/64
Switch(Config-if-Vlan1)#ipv6 pim dense-mode
Switch(Config-if-Vlan1)#exit
Switch(config)#interface vlan2
Switch(Config-if-Vlan2)#ipv6 address 2000:12:1:1:: 1/64
Switch(Config-if-Vlan2)#ipv6 pim dense-mode
```

### (2) Configure SwitchB:

```
Switch(config)#ip pim multicast-routing
Switch(config)#interface vlan 1
Switch(Config-if-Vlan1)#ipv6 address 2000:12:1:1::2/64
Switch(Config-if-Vlan1)#ipv6 pim dense-mode
Switch(Config-if-Vlan1)#exit
Switch(config)#interface vlan 2
Switch(Config-if-Vlan2)#ipv6 address 2000:20:1:1::1/64
Switch(Config-if-Vlan2)#ipv6 pim dense-mode
```

## 49.1.4 PIM-DM6 Troubleshooting

When configuring and using PIM-DM protocol, PIM-DM protocol may fail to work normally due to physical connections, incorrect configuration and so on. So, users shall note the following points:

- Assure the physical connection is correct.
- Assure the Protocol of Interface and Link is UP (use show interface command);
- Assure PIM Protocol is turned on in Global Mode (use ipv6 pim multicast-routing command )
- Start PIM-DM Protocol on the interface (use ipv6 pim dense-mode command)

Unicast route shall be used to carry out RPF examination for multicast protocol. So the correctness of unicast route shall be guaranteed above all. If all attempts fail to solve the problems on PIM-DM, then use debug commands such as debug ipv6 pim, copy DEBUG information in 3 minutes and send to Technology Service Center.

## 49.2 PIM-SM6

### 49.2.1 Introduction to PIM-SM6

PIM-SM6 ( Protocol Independent Multicast, Sparse Mode ) is the IPv6 version of Protocol Independent Multicast Sparse Mode. It is a multicast routing protocol in sparse mode and mainly used in large network with group members distributed relatively sparse and wide. It is no difference from the IPv4 version PIM-SM except the addresses it uses are IPv6 addresses. Thus we don't differentiate between PIM-SM and PIM-SM6 in this chapter. All PIM-SM in the text without specific explanation is IPv6 version PIM-SM. Unlike the Flooding-Prune of Dense Mode, PIM-SM Protocol assumes no host needs receiving multicast data packets.

---

PIM-SM router forwards multicast data packets to a host only on definite request.

By setting RP (Rendezvous Point) and BSR (Bootstrap Router), PIM-SM announce multicast packet to all PIM-SM routers and establish, using Join/Prune message of routers, RPT (RP-rooted shared tree) based on RP. Consequently the network bandwidth occupied by data packets and control messages is cut down and the transaction cost of routers is reduced. Multicast data get to the network segment where the multicast group members are located along the shared tree flow. When the data traffic reaches a certain amount, multicast data stream can be switched to source-based SPT (Shortest Path Tree) to shorten network delay. PIM-SM doesn't rely on any specific unicast routing protocol but make RPF examination using existing unicast routing table.

## 1. PIM-SM Working Principle

The working process of PIM-SM mainly includes neighbor discovery, creation of RPT, registration of multicast source, SPT switch and so on. The neighbor discovery mechanism is the same with the mechanism of PIM-DM. We won't introduce any more.

### (1) Creation of RP Shared Tree (RPT)

When a host joins a multicast group G, the leaf router directly connected with the host finds out through IGMP message that there is a receiver of multicast group G, then it works out the corresponding Rendezvous Point RP for multicast group G, and send join message to upper level nodes in RP direction. Every router on the way from the leaf router to RP will create a (\*, G) table item, indicating the message from any source to multicast group G is suitable for this item. When RP receives the message sent to multicast group G, the message will get to the leaf router along the established path and then reach the host. In this way, the RPT with RP as root is created.

### (2) Multicast Source Registration

When multicast source S sends a multicast packet to multicast group G, the PIM-SM multicast router directly connected to it will take charge of sealing the multicast packet into registered message and unicast it to corresponding RP. If there are more than one PIM-SM multicast routers on a network segment, then DR (Designated Router) takes charge of forwarding the multicast packet.

### (3) SPT Switch

Once the multicast router finds that the rate of the multicast packet from RP with destination address G exceeds threshold, the multicast router will send Join message to the upper level nodes in the source direction, which results in the switch from RPT to SPT.

## 2. Preparation before PIM-SM configuration

### (1) Configuration Candidate RP

More than one RPs (candidate RP) are permitted in PIM-SM network and each C-RP (Candidate RP) takes charge of forwarding multicast packets with destination address in a certain range. To configure more than one candidate RPs can achieve RP load balancing. There is no master or slave difference among RPs. All multicast routers work out the RP corresponded with certain multicast group based on the same algorithm after receiving the candidate RP message announced by BSR.

Note that one RP can serve more than one multicast groups, even all multicast groups. But each multicast group can only correspond with one unique RP at any moment. It can't correspond with more RPs at the same time.

### (2) BSR Configuration

As the management core of PIMSM network, BSR is in charge of collecting messages sent by candidate RPs and broadcast them..

There may be only one BSR within a network. However, there may be several candidate BSRs to be

configured. With such arrangement, once a BSR fails, another may be switched to. C-BSR determines BSR through automatic selection.

Notice: Multicast Routing Protocol is not supported by 5950-28T-L and 5950-52T-L in this chapter.

## 49.2.2 PIM-SM6 Configuration Task List

- 1 · Enable PIM-SM (Required)
- 2 · Configure static multicast routing entries (Optional)
- 3 · Configure additional parameters for PIM-SM (Optional)
- (1) Configure parameters for PIM-SM interfaces
  - 1) Configure the interval for PIM-SM hello messages
  - 2) Configure the holdtime for PIM-SM hello messages
  - 3) Configure ACL for PIM-SM6 neighbors
  - 4) Configure the interface as the boundary interface of the PIM-SM6 protocol
  - 5) Configure the interface as the management boundary of the PIM-SM6 protocol
- (2) Configure global PIM-SM parameters
  - 1) Configure the switch as a candidate BSR
  - 2) Configure the switch as a candidate RP
  - 3) Configure static RP
  - 4) Configure the cache time of kernel multicast route
- 4 · Disable the PIM-SM protocol

### 1. Enable PIM-SM protocol

The PIM-SM protocol can be enabled on SGS-6341 Series Layer 3 switches by enabling PIM6 in global configuration mode and then enabling PIM-SM for specific interfaces in the interface configuration mode.

Command	Explanation
Global Configuration Mode	
<b>[no] ipv6 pim multicast-routing</b>	To enable the PIM-SM6 protocol for all the interfaces (However, in order to make PIM-SM work for specific interfaces, the following command should be issued). (required)

Make the PIM-SM protocol work for specific interfaces

Command	Explanation
Interface Configuration Mode	
<b>[no] ipv6 pim sparse-mode [passive]</b>	To enable PIM-SM for the specified interface. The no form of this command will disable the PIM-SM protocol (required).

## 2 · Configure static multicast routing entries

Command	Explanation
Global Configuration Mode	
<b>ipv6 mroute &lt;X:X::X:X&gt; &lt;X:X::X:X&gt; &lt;ifname&gt; &lt;ifname&gt; no ipv6 mroute &lt;X:X::X:X&gt; &lt;X:X::X:X&gt; [&lt;ifname&gt; &lt;ifname&gt;]</b>	To configure a static multicast routing entry. The no form of this command will remove the specified static multicast routing entry.

## 3. Configure the additional parameters for PIM-SM

### (1) Configure parameters for PIM-SM interfaces

#### 1) Configure the interval for PIM-SM hello messages

Command	Explanation
Interface Configuration Mode	
<b>ipv6 pim hello-interval &lt;interval&gt; no ipv6 pim hello-interval</b>	To configure the interval for PIM-SM hello messages. The no form of this command restores the interval to the default value.

#### 2) Configure the hold time for PIM-SM6 hello messages

Command	Explanation
Interface Configuration Mode	
<b>ipv6 pim hello-holdtime &lt;value&gt; no ipv6 pim hello-holdtime</b>	To configure the value of the holdtime field in the PIM-SM hello messages. The no form of this command will restore the hold time to the default value.

#### 3) Configure ACL for PIM-SM6 neighbors

Command	Explanation
Interface Configuration Mode	
<b>ipv6 pim neighbor-filter &lt;access-list-name&gt; no ipv6 pim neighbor-filter &lt;access-list-name&gt;</b>	To configure ACL to filter PIM-SM6 neighbor. If session to the neighbor has been denied by ACL, then the sessions that have been set up will be discarded immediately and new sessions will not be set up.

#### 4) Configure the interface as the boundary interface of the PIM-SM6 protocol

Command	Explanation
Interface Configuration Mode	



<b>ipv6 pim bsr-border</b> <b>no ipv6 pim bsr-border</b>	To configure the interface as the boundary of PIM-SM6 protocol. On the boundary interface, BSR messages will not be sent or received. The network connected the interface is considered as directly connected network. The no form of this command will remove the configuration.
---	---

5) Configure the interface as the management boundary of the PIM-SM6 protocol

Command	Explanation
Interface Configuration Mode	
<b>ipv6 pim scope-border</b> <b>&lt;500-599&gt; &lt;acl_name&gt;</b> <b>no ipv6 pim scope-border</b>	To configure PIM-SM6 management boundary for the interface and apply ACL for the management boundary. With default settings, ffx0::/13 is considered as the scope of the management group. If ACL is configured, then the scope specified by ACL permit command is the scope of the management group. acl_name should be standard IPv6 ACL name. The no form of this command will remove the configuration.

**(2) Configure global PIM-SM6 parameter**

1) Configure the switch as a candidate BSR

Command	Explanation
Global Configuration Mode	
<b>ipv6 pim bsr-candidate {vlan</b> <b>&lt;vlan_id&gt; &lt;ifname&gt;   tunnel</b> <b>&lt;1-50&gt;}[hash-mask-length]</b> <b>[priority]</b> <b>no ipv6 pim bsr-candidate {vlan</b> <b>&lt;vlan_id&gt; &lt;ifname&gt;   tunnel</b> <b>&lt;1-50&gt;}[hash-mask-length]</b> <b>[priority]</b>	This command is the global candidate BSR configuration command, which is used to configure the information of PIM-SM candidate BSR so that it can compete for BSR router with other candidate BSR. The no operation is to cancel the configuration of BSR.

2) Configure the switch as a candidate RP

Command	Explanation
Global Configuration Mode	

<b>ipv6 pim rp-candidate</b> <b>{vlan&lt;vlan-id&gt; </b> <b>loopback&lt;index&gt; &lt;ifname&gt;}</b> <b>[&lt;group range&gt;] [&lt;priority&gt;]</b> <b>no ipv6 pim rp-candidate</b>	This command is the global candidate RP configuration command, which is used to configure the information of PIM-SM candidate RP so that it can compete for RP router with other candidate RP. The no operation is to cancel the configuration of RP.
--	---

### 3) Configure static RP

Command	Explanation
Global Configuration Mode	
<b>ipv6 pim rp-address &lt;rp-address&gt;</b> <b>[&lt;group-range&gt;]</b> <b>no ipv6 pim rp-address</b> <b>&lt;rp-address&gt; {all &lt;group-range&gt;}</b>	To configure the address of the candidate RP. The no form of this command will remove the configuration for the candidate RP.

### 4) Configure the cache time of kernel multicast route

Command	Explanation
Global Configuration Mode	
<b>ipv6 multicast unresolved-cache</b> <b>aging-time &lt;value&gt;</b> <b>no ipv6 multicast unresolved-cache</b> <b>aging-time</b>	Configure the cache time of kernel multicast route, the no command restores the default value.

### 4. Disable PIM-SM protocol

Command	Explanation
Interface Configuration Mode	
<b>no ipv6 pim sparse-mode</b>	To disable the PIM-SM6 protocol.
Global Configuration Mode	
<b>no ipv6 pim sparse-mode</b>	To disable PIM-DM globally.

## 49.2.3 PIM-SM6 Typical Application

As shown in the following figure, add the Ethernet interfaces of SwitchA, SwitchB, SwitchC and SwitchD to corresponding VLAN, and start PIM-SM Protocol on each VLAN interface.

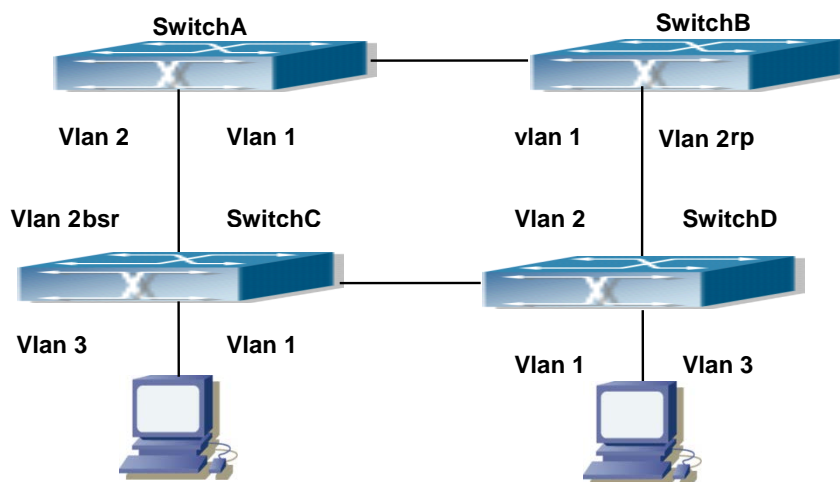

**Figure 49-2 PIM-SM Typical Environment**

The configuration procedure for SwitchA, SwitchB, SwitchC and SwitchD is as below:

**(1) Configure SwitchA:**

```
Switch(config)#ipv6 pim multicast-routing
Switch(config)#interface vlan 1
Switch(Config-if-Vlan1)#ipv6 address 2000:12:1:1::1/64
Switch(Config-if-Vlan1)#ipv6 pim sparse-mode
Switch(Config-if-Vlan1)#exit
Switch(config)#interface vlan 2
Switch(Config-if-Vlan2)#ipv6 address 2000:13:1:1::1/64
Switch(Config-if-Vlan2)#ipv6 pim sparse-mode
```

**(2) Configure Switch B:**

```
Switch(config)#ipv6 pim multicast-routing
Switch(config)#interface vlan 1
Switch(Config-if-Vlan1)#ipv6 address 2000:12:1:1::2/64
Switch(Config-if-Vlan1)#ipv6 pim sparse-mode
Switch(Config-if-Vlan1)#exit
Switch(config)#interface vlan 2
Switch(Config-if-Vlan2)#ipv6 address2000:24:1:1::2/64
Switch(Config-if-Vlan2)#ipv6 pim sparse-mode
Switch(Config-if-Vlan2)#exit
Switch(config)#ipv6 pim rp-candidate vlan2
```

**(3) Configure SwitchC:**

```
Switch(config)#ipv6 pim multicast-routing
Switch(config)#interface vlan 1
Switch(Config-if-Vlan1)#ipv6 address 2000:34:1:1::3/64
```

```
Switch(Config-if-Vlan1)#ipv6 pim sparse-mode
Switch(Config-if-Vlan1)#exit
Switch(config)#interface vlan 2
Switch(Config-if-Vlan2)#ipv6 address 2000:13:1:1::3/64
Switch(Config-if-Vlan2)#ipv6 pim sparse-mode
Switch(Config-if-Vlan2)#exit
Switch(config)#interface vlan 3
Switch(Config-if-Vlan3)#ipv6 address 2000:30:1:1::1/64
Switch(Config-if-Vlan3)#ipv6 pim sparse-mode
Switch(Config-if-Vlan3)#exit
Switch(config)#ipv6 pim bsr-candidate vlan2 30 10
```

#### (4) Configure SwitchD:

```
Switch(config)#ipv6 pim multicast-routing
Switch(config)#interface vlan 1
Switch(Config-if-Vlan1)#ipv6 address 2000:34:1:1::4/64
Switch(Config-if-Vlan1)#ipv6 pim sparse-mode
Switch(Config-if-Vlan1)#exit
Switch(config)#interface vlan 2
Switch(Config-if-Vlan2)#ipv6 address 2000:24:1:1::4/64
Switch(Config-if-Vlan2)#ipv6 pim sparse-mode
Switch(Config-if-Vlan2)#exit
Switch(config)#interface vlan 3
Switch(Config-if-Vlan3)#ipv6 address 2000:40:1:1::1/64
Switch(Config-if-Vlan3)#ipv6 pim sparse-mode
```

## 49.2.4 PIM-SM6 Troubleshooting

When configuring and using PIM-SM protocol, PIM-SM protocol may fail to work normally due to physical connections, incorrect configuration and so on. So, users shall note the following points:

- Assure the physical connection is correct.
- Assure the Protocol of Interface and Link is UP (use show interface command);
- Unicast route shall be used to carry out RPF examination for multicast protocol. So the correctness of unicast route shall be guaranteed above all.
- PIM-SM Protocol requires supports of RP and BSR, therefore you should use show ipv6 pim bsr-router first to see if there is BSR information. If not, you need to check if there is unicast routing leading to BSR.
- Use show ipv6 pim rp-hash command to check if RP information is correct; if there is no RP information, you still need to check unicast routing;

If all attempts fail to solve the problems on PIM-SM, then use debug commands such as debug ipv6 pim/ debug ipv6 pim bsr, copy DEBUG information in 3 minutes and send to Technology Service Center.

---

## 49.3 ANYCAST RP v6 Configuration

### 49.3.1 Introduction to ANYCAST RP v6

Anycast RP v6 is a technology based on PIM protocol, which provides redundancy in order to recover as soon as possible once an RP becomes unusable.

The kernel concept of Anycast RP v6 is that the RP addresses configured all over the whole network exist on multiple multicast servers (the most common situation is that every device providing ANYCAST RP uses LOOPBACK interface, and using the longest mask to configures RP addresses on this interface), while the unicast routing algorithm will make sure that PIM routers can always find the nearest RP, thus , providing a shorter and faster way to find RP in a larger network., Once an RP being used becomes unusable, the unicast routing algorithm will ensure that the PIM router can find a new RP path fast enough to recover the multicast server in time. Multiple RP will cause a new problem that is if the multicast source and the receivers are registered to different RP, some receivers will not be able to receive data of multicast source (obviously, the register messages only prefer the nearest RP). So, in order to keep the communication between all RP, Anycast RP defines that the nearest RP to the multicast source should forward the source register messages to all the other RP to guarantee that all joiners of the RP can find the multicast source.

The method to realize the PIM-protocol-based Anycast RP is that: maintaining an ANYCAST RP list on every switch configured with Anycast RP and using another address as the label to identify each other. When one Anycast RP device receives a register message, it will send the register message to other Anycast RP devices while using its own address as the source address, to notify all the other devices of the original destination.

### 49.3.2 ANYCAST RP v6 Configuration Task

1. Enable ANYCAST RP v6 function
2. Configure ANYCAST RP v6

#### 1. Enable ANYCAST RP v6 function

Command	Explanation
Global Configuration Mode	
<b>ipv6 pim anycast-rp</b> <b>no ipv6 pim anycast-rp</b>	Enable ANYCAST RP function. (necessary) The no operation will globally disable the ANYCAST RP function.

#### 2. Configure ANYCAST RP v6

##### (1) Configure RP candidate

Command	Explanation
Global Configuration Mode	
<b>ipv6 pim rp-candidate {vlan&lt;vlan-id&gt;  loopback&lt;index&gt;  &lt;ifname&gt;} [&lt;A::B::C:D&gt;][&lt;priority&gt;]</b>	Now, the PIM-SM has allowed the Loopback interface to be a RP candidate.(necessary) Please pay attention to that, ANYCAST RP

<b>no ipv6 pim rp-candidate</b>	<p>protocol can configure the Loopback interface or a regular three-layer VLAN interface to be the RP candidate. In make sure that PIM routers in the network can find where the RP locates, the RP candidate interface should be added into the router.</p> <p>No operation will cancel the RP candidate configured on this router.</p>
---------------------------------	--

**(2) Configure self-rp-address (the RP communication address of this router)**

Command	Explanation
Global Configuration Mode	
<b>ipv6 pim anycast-rp self-rp-address A::C:D no ipv6 pim anycast-rp self-rp-address</b>	<p>Configure the self-rp-address of this router (as a RP). This address can be used to exclusively identify this router when communicating with other RP.(necessary)</p> <p>the effect of <b>self-rp-address</b> refers to two respects:</p> <p>1 Once this router (as a RP) receives the register message from a DR unicast, it needs to forward the register message to all the other RP in the network, notifying them of the state of source (S,G). While forwarding the register message, this router will change the source address of it into self-rp-address.</p> <p>2 Once this router(as a RP) receives a register message from other RP unicast, such as a register message whose destination is the self-rp-address of this router, it will create (S,G) state and send back a register-terminating message, whose destination address is the source address of the register message.</p> <p>Pay attention: self-rp-address has to be the address of a three-layer interface on this router, but the configuration is allowed to be done with the absence of the interface. The self-rp-address should be unique.</p> <p>No operation will cancel the self-rp-address which is used to communicate with other RP by this router.</p>

**(3) Configure other-rp-address (other RP communication addresses)**

Command	Explanation
<p>Global Configuration Mode</p> <p><b>ipv6 pim anycast-rp &lt;anycast-rp-addr&gt; &lt;other-rp-addr&gt;</b></p> <p><b>no ipv6 pim anycast-rp &lt;anycast-rp-addr&gt; &lt;other-rp-addr&gt;</b></p>	<p>Configure anycast-rp-addr on this router (as a RP). This unicast address is actually the RP address configured on multiple RP in the network, in accordance with the address of RP candidate interface (or Loopback interface).</p> <p>The effect of <b>anycast-rp-addr</b> includes:</p> <ol style="list-style-type: none"> <li>1 Although more than one anycast-rp-addr addresses are allowed to be configured, only the one having the same address with the currently configured RP candidate address will take effect. Only after that, can the other-rp-address in accordance with this anycast-rp-addr take effect.</li> <li>2 The configuration is allowed to be done with the absence of the interface in accordance with the anycast-rp-addr. Configure on this router (as a RP) the other-rp-addresses of other RP communicating with it. This unicast address identifies other RP and is used in the communication with local routers. The effect of <b>other-rp-address</b> refers to two respects:             <ol style="list-style-type: none"> <li>1 Once this router (as a RP) receives the register message from a DR unicast, it should forward it to other RP in the network to notify all the RP in the network of the source (S.G) state. While forwarding, the router will change the destination address of the register message into other-rp-address.</li> <li>2 Multiple other-rp-addresses can be configured in accordance with one anycast-rp-addr, Once the register message from a DR is received, it should be forwarded to all of this RP one by one.</li> </ol> </li> </ol> <p>No operation will cancel other-rp-address communicating with this router.</p>

### 49.3.3 ANYCAST RP v6 Configuration Examples

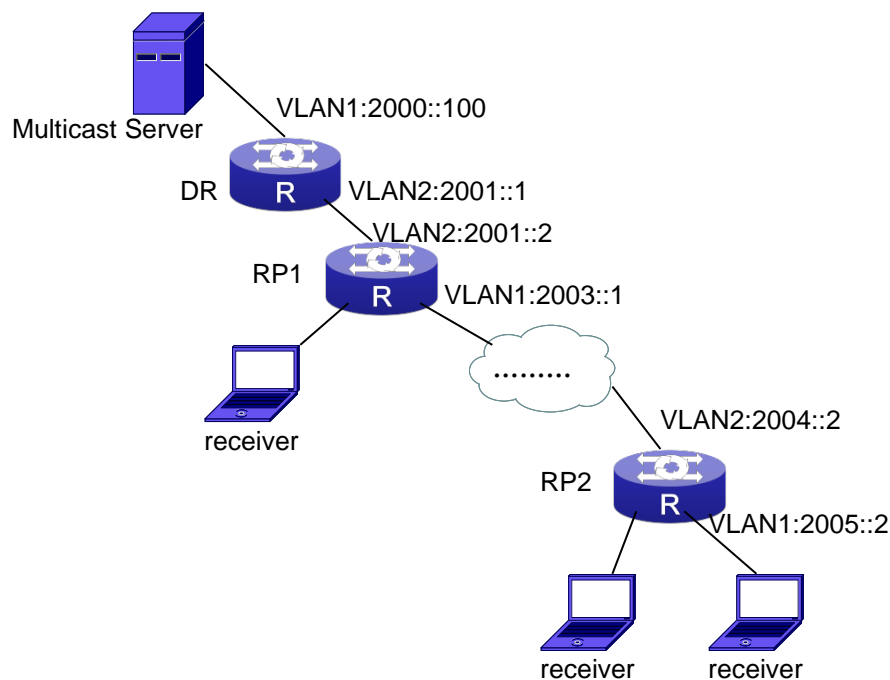

Figure 49-3 The ANYCAST RP v6 function of a router

The following is the configuration steps:

#### RP1 Configuration:

```
Switch#config
Switch(config)#interface loopback 1
Switch(Config-if-Loopback1)#ipv6 address 2006::1/128
Switch(Config-if-Loopback1)#exit
Switch(config)#ipv6 pim rp-candidate loopback1
Switch(config)#ipv6 pim bsr-candidate vlan 1
Switch(config)#ipv6 pim multicast-routing
Switch(config)#ipv6 pim anycast-rp
Switch(config)#ipv6 pim anycast-rp self-rp-address 2003::1
Switch(config)#ipv6 pim anycast-rp 2006::1 2004::2
```

#### RP2 Configuration:

```
Switch#config
Switch(config)#interface loopback 1
Switch(Config-if-Loopback1)#ipv6 address 2006::1/128
Switch(Config-if-Loopback1)#exit
Switch(config)#ipv6 pim rp-candidate loopback1
Switch(config)#ipv6 pim multicast-routing
Switch(config)#ipv6 pim anycast-rp
```



```
Switch(config)#ipv6 pim anycast-rp self-rp-address 2004::2
Switch(config)#ipv6 pim anycast-rp 2006::1 2003::1
```

Please pay attention to that, for promulgating loopback interface router, if use MBGP4+ protocol, then can use network command; or use RIPng protocol, then can use route command.

### 49.3.4 ANYCAST RP v6 Troubleshooting

When configuring and using ANYCAST RP v6 function, the ANYCAST RP might work abnormally because of faults in physical connections, configurations or something others. So, the users should pay attention to the following points:

- The physical connections should be guaranteed to be correct
- The PIM-SM6 protocol should be guaranteed to operate normally
- The ANYCAST RP should be guaranteed to be enabled in Global configuration mode
- The self-rp-address should be guaranteed to be configured correctly in Global configuration mode
- The other-rp-address should be guaranteed to be configured correctly in Global configuration mode
- All the interface routers should be guaranteed to be correctly added, including the loopback interface as a RP
- Use “**show ipv6 pim anycast rp status**” command to check whether the configuration information of ANYCAST RP is correct

If the problems of ANYCAST still cannot be solved after checking, please use debug commands like “debug ipv6 pim anycast-rp”, then copy the DEBUG information within three minutes and send it to the technical service center of our company.

## 49.4 PIM-SSM6

### 49.4.1 Introduction to PIM-SSM6

Source Specific Multicast (PIM-SSM6) is a new kind of multicast service protocol. With PIM-SSM6, a multicast session is distinguished by the multicast group address and multicast source address. In SSM6, hosts can be added into the multicast group manually and efficiently like the traditional PIM-SM6, but leave out the shared tree and RP management in PIM-S6M. In SSM6, SPT tree will be constructed with (S,G). G for the multicast group address and S for the source address of the multicast which sends datagram to G. (S,G) in a pair is named as a channel of SSM6. SSM6 serves best for the application of multicast service which is from one station to many ones, for example, the network sports video channel, and the news channel. By default, the multicast group address of SSM6 is limited to ff3x::/32. However this address range can be extended according to actual situations.

PIM-SSM6 can be supported in the PIM-DM6 environment.

## 49.4.2 PIM-SSM6 Configuration Task List

Command	Explanation
Global configuration mode	
<b>ipv6 pim ssm {default range &lt;access-list-number&gt;}</b> <b>no ipv6 pim ssm</b>	To configure address range for pim-ssm multicast group. The no prefix will disable this command.

## 49.4.3 PIM-SSM6 Configuration Example

As it is shown in the below figure, ethernet interfaces of switchA, switchB, switchC, and switchD are separated into different vlan. And PIM-SSM6 or PIM-DM6 is enabled on all the vlan interfaces. Take configuration of PIM-SSM6 for example.

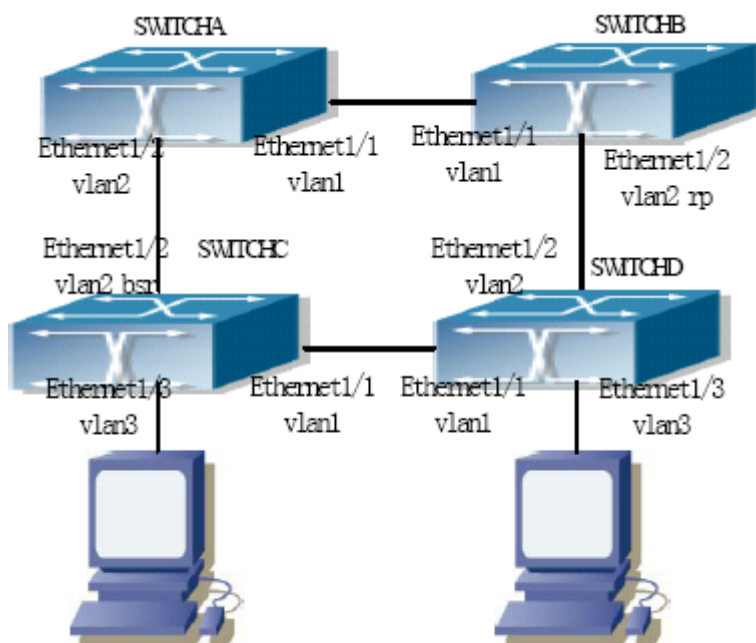

**Figure 49-4** PIM-SSM typical environment

Configurations of switchA , switchB, switchC and switchD are listed as below:

### (1) Configuration of switchA :

```
Switch(config)#ipv6 pim multicast-routing
Switch(config)#interface vlan 1
Switch(Config-If-Vlan1)# ipv6 address 2000:12:1:1::1/64
Switch(Config-If-Vlan1)# ipv6 pim sparse-mode
Switch(Config-If-Vlan1)#exit
Switch(config)#interface vlan 2
Switch(Config-If-Vlan2)# ipv6 address 2000:13:1:1::1/64
Switch(Config-If-Vlan2)# ipv6 pim sparse-mode
```

```
Switch(Config-If-Vlan2)#exit
Switch(config)#ipv6 access-list 500 permit ff1e::1/64
Switch(config)#ip pim ssm range 500
```

### **(2) Configuration of switchB :**

```
Switch(config)#ipv6 pim multicast-routing
Switch(config)#interface vlan 1
Switch(Config-If-Vlan1)# ipv6 address 2000:12:1:1::2/64
Switch(Config-If-Vlan1)# ipv6 pim sparse-mode
Switch(Config-If-Vlan1)#exit
Switch(config)#interface vlan 2
Switch(Config-If-Vlan2)# ipv6 address2000:24:1:1::2/64
Switch(Config-If-Vlan2)# ipv6 pim sparse-mode
Switch(Config-If-Vlan2)# exit
Switch(config)# ipv6 pim rp-candidate vlan2
Switch(config)#ipv6 access-list 500 permit ff1e::1/64
Switch(config)#ip pim ssm range 500
```

### **(3) Configuration of SwitchC :**

```
Switch(config)#ipv6 pim multicast-routing
Switch(config)#interface vlan 1
Switch(Config-If-Vlan1)# ipv6 address 2000:34:1:1::3/64
Switch(Config-If-Vlan1)# ipv6 pim sparse-mode
Switch(Config-If-Vlan1)#exit
Switch(config)#interface vlan 2
Switch(Config-If-Vlan2)# ipv6 address 2000:13:1:1::3/64
Switch(Config-If-Vlan2)# ipv6 pim sparse-mode
Switch(Config-If-Vlan2)#exit
Switch(config)#interface vlan 3
Switch(Config-If-Vlan3)# ipv6 address 2000:30:1:1::1/64
Switch(Config-If-Vlan3)# ipv6 pim sparse-mode
Switch(Config-If-Vlan3)# exit
Switch(config)# ipv6 pim bsr-candidate vlan2 30 10
Switch(config)#ipv6 access-list 500 permit ff1e::1/64
Switch(config)#ip pim ssm range 500
```

### **(4) Configuration of SwitchD :**

```
Switch(config)#ipv6 pim multicast-routing
Switch(config)#interface vlan 1
Switch(Config-If-Vlan1)# ipv6 address 2000:34:1:1::4/64
Switch(Config-If-Vlan1)# ipv6 pim sparse-mode
Switch(Config-If-Vlan1)#exit
Switch(config)#interface vlan 2
```

```
Switch(Config-If-Vlan2)# ipv6 address 2000:24:1:1::4/64
Switch(Config-If-Vlan2)# ipv6 pim sparse-mode
Switch(Config-If-Vlan2)#exit
Switch(config)#interface vlan 3
Switch(Config-If-Vlan3)# ipv6 address 2000:40:1:1::1/64
Switch(Config-If-Vlan3)# ipv6 pim sparse-mode
Switch(Config-If-Vlan3)#exit
Switch(config)#ipv6 access-list 500 permit ff1e::1/64
Switch(config)#ip pim ssm range 500
```

## 49.4.4 PIM-SSM6 Troubleshooting

When configuring the PIM-SSM6 protocol, it may fail to work because of the failure of physical connection or the mis-configurations. To debug these errors, attention should be paid to the following lists.

- Make sure the physical links are connected correctly.
- Make sure the state of the data link layer has become UP. (Use show interface command).
- Make sure PIM6 is enabled in global configuration mode (Refer to the command `ipv6 pim multicast-routing`).
- Make sure PIM-SM6 is configured on the interface (Refer to the command `ipv6 pim sparse-mode`)
- Make sure SSM6 is configure in global configuration mode.
- The multicast protocol uses the unicast routing to make RPF check. Hence, single-cast routing should be verified firstly.

If problems could not be fixed with the above check list, please enable the command of **debug ipv6 pim event and debug ipv6 pim packet**, and save the debug information for 3 minutes, and send it to Technology Service Center.

## 49.5 IPv6 DCSCM

### 49.5.1 Introduction to IPv6 DCSCM

The technology of IPv6 DCSCM (Destination Control and Source Control Multicast) includes three aspects: the multicast source control, the multicast user control and the service-priority-oriented policy multicast.

IPv6 DCSCM Controllable Multicast technology proceeds as the following way:

1. If source controlled multicast is configured on the edge switches, only the multicast data of the specified group from the specified source can pass.
2. The RP switches which are the core of PIM-SM will directly send REGISTER\_STOP as response to the REGISTER messages not from the specified source and specified group, and no entry is allowed to be created. (This task is implemented in the PIM-SM module).

The control of multicast users of IPv6 DCSCM technology is implemented on the basis of controlling the MLD message sent from the users, so the control module is MLD snooping and the MLD module, the control logic of which includes the following three methods: controlling according to the VLAN+MAC sending the message,

controlling according to the IP address sending the message, and controlling according to the input port of the message. MLD snooping can adopt all the three methods at the same time, while the MLD module, at the third layer, can only control the IP address sending the message.

The service-priority-oriented policy multicast of IPv6 DCSCM technology adopts the following method: for the confined multicast data, the user-specified priority will be set at the access point, enabling the data can be sent at a higher priority through TRUNK, and guaranteeing that the data can be sent through the whole net at the user-specified priority.

## 49.5.2 IPv6 DCSCM Configuration Task Sequence

- 1 · The source control configuration
- 2 · The destination control configuration
- 3 · The multicast policy configuration

### 1 · The source control configuration

The source control configuration has three steps, first is globally enabling the source control, the following is the command of globally enabling the source control:

Command	Explanation
Global Configuration Mode	
<b>ipv6 multicast source-control(necessary)</b> <b>no ipv6 multicast source-control</b>	Globally enable the source control, the no operation of this command will globally disable the source control. What should be paid attention to is that, once globally enable the source control, all the multicast messages will be dropped by default. All the source control configurations can only be done after globally enabled, and only when all the configured rules are disabled, the source control can be disabled globally.

The next is configuring the source control rules, which adopts the same method as configuring ACL, using ACL number from 8000 to 8099, while each rule number can configure 10 rules. What should be paid attention to is that these rules have orders, the earliest configured rule is at the front. Once a rule is matched, the following ones will not take effect, so the globally enabled rules should be the last to configure. The following is the command:

Command	Explanation
Global Configuration Mode	
<b>[no] ipv6 access-list &lt;8000-8099&gt;</b> <b>{deny permit}</b> <b>{{&lt;source/M&gt;}{host-source</b> <b>&lt;source-host-ip&gt;} any-source}</b> <b>{{&lt;destination/M&gt; } {host-destination</b> <b>&lt;destination-host-ip&gt;} any-destination}</b>	Used to configure the source control rules, the rules can only take effect when applied to the specified port. The no operation of this command can delete the specified rule.

The last is to configure the rules to the specified port.

Pay attention: since the configured rules will take up entries of hardware, configuring too many rules might cause failure if the underlying entries are full, so it is recommended that users adopt rules as simple as possible. The following is the configuration command:

Command	Explanation
Port Configuration Mode	
<b>[no] ipv6 multicast source-control access-group &lt;8000-8099&gt;</b>	Used to configure the source control rule to a port, the no operation will cancel this configuration.

## 2 · The configuration of destination control

The configuration of destination control is similar to that of source control, and also has three steps:

First, globally enable the destination control, since destination control needs to avoid the unauthorized users from receiving multicast data, once it is enabled globally, the switch will stop broadcasting received multicast data, so if a switch has enabled destination control, users should not connect two or more other Layer three switches within the same VLAN where it locates. The following is the configuration command:

Command	Explanation
Global Configuration Mode	
<b>multicast destination-control(necessary)</b>	Globally enable IPV4 and IPv6 destination control, the no operation of this command will globally disable destination control. All of the other configuration can only take effect after globally enabled.

The next is configuring destination control rules, which are similar to that of source control, but using ACL number from 9000 to 10099 instead.

Command	Explanation
Global Configuration Mode	
<b>[no] ipv6 access-list &lt;9000-10099&gt; {deny permit} {{&lt;source/M&gt;}{host-source &lt;source-host-ip&gt;}{any-source} {{&lt;destination/M&gt;}{host-destination &lt;destination-host-ip&gt;}{any-destination}}</b>	Used to configure destination control rules, these rules can only take effect when applied to specified source IP, VLAN-MAC or port. The no operation of this rule will delete the specified rule.

The last step is to configure the rules to the specified source IP, source VLAN MAC or the specified port. What should be paid attention to is that only when the MLD-SNOOPING is enabled, these rules can be globally used, or, only rules of source IP can be used in MLD protocol. The following is the configuration command:

Command	Explanation
Port Mode	
<b>[no] ipv6 multicast destination-control access-group &lt;9000-10099&gt;</b>	Used to configure the destination control rule to a port, the no operation of this command will cancel the configuration.
Global Configuration Mode	
<b>[no] ipv6 multicast destination-control &lt;1-4094&gt; &lt;macaddr&gt; access-group &lt;9000-10099&gt;</b>	Used to configure the destination control rules to the specified VLAN-MAC, the no operation of this command will cancel the configuration.
<b>[no] ipv6 multicast destination-control &lt;IPADDRESS/M&gt; access-group &lt;9000-100999&gt;</b>	Used to configure the destination control rules to the specified source IPv6 address/MASK, the no operation of this command will cancel the configuration.

### 3 · The configuration of multicast policy

The multicast policy adopts the method of specifying a priority for the specified multicast data to meet the user's particular demand, what should be paid attention to is that only when multicast data is transmitted in TRUNK, can it be taken special care of. The configuration is quite simple, for only one command is needed, that is set priority for the specified multicast, the following is the command:

Command	Explanation
Global Configuration Mode	
<b>[no] ipv6 multicast policy &lt;IPADDRESS/M&gt; &lt;IPADDRESS/M&gt; cos &lt;priority&gt;</b>	Configure multicast policy, set priority for sources and groups in a specified range, the priority valid range is 0 to 7.

## 49.5.3 IPv6 DCSCM Typical Examples

### 1 · Source control

In order to prevent an edge switch sends multicast data at will, we configure on the edge switch that only the switch whose port is Ethernet1/0/5 can send multicast data, and the group of data should be ff1e::1. The uplink port Ethernet1/0/25 can forward multicast data without being restricted, so we can configure as follows.

```
Switch(config)#ipv6 access-list 8000 permit any-source ff1e::1
Switch(config)#ipv6 access-list 8001 permit any any
Switch(config)#ipv6 multicast source-control
Switch(config)#interface Ethernet1/0/5
Switch(Config-If-Ethernet1/0/5)#ipv6 multicast source-control access-group 8000
Switch(config)#interface Ethernet1/0/25
Switch(Config-If-Ethernet1/0/25)#ipv6 multicast source-control access-group 8001
```

---

## 2 · Destination control

We want to confine that the users of the segment whose address is fe80::203:fff:fe01:228a/64 can not join the ff1e::1/64 group, so we can configure as follows:

First, enable MLD Snooping in the VLAN where it locates (in this example, it is VLAN2).

```
Switch(config)#ipv6 mld snooping
Switch(config)#ipv6 mld snooping vlan 2
```

Then configure relative destination control access list and configure specified IPv6 address to use this access list.

```
Switch(config)#ipv6 access-list 9000 deny any ff1e::1/64
Switch(config)#ipv6 access-list 9000 permit any any
Switch(config)#multicast destination-control
Switch(config)#ipv6 multicast destination-control fe80::203:fff:fe01:228a/64 access-group 9000
```

Thus, the users of this segment can only join groups other than 2ff1e::1/64.

## 3 · Multicast policy

Server 2008::1 is sending important multicast data in group ff1e::1, we can configure on its access switch as follows:

```
Switch(config)#ipv6 multicast policy 2008::1/128 ff1e::1/128 cos 4
```

Thus this multicast flow will have a priority of 4, when it passes the TRUNK port of this switch to another switch (generally speaking, it is a relatively high priority, the data with higher priority might be protocol data, if a higher priority is set, when there is too much multicast data, the switch protocol might operate abnormally).

## 49.5.4 IPv6 DCSCM Troubleshooting

IPv6 DCSCM module acts like ACL, so most problems are caused by improper configuration. Please read the instructions above carefully.

## 49.6 MLD

### 49.6.1 Introduction to MLD

MLD (Multicast Listener Discovery) is the multicast group member (receiver) discovery protocol serving IPv6 multicast. It is similar to IGMP Protocol in IPv4 multicast application. Correspondingly, MLD Protocol version1 is similar to IGMP Protocol version2, and MLD Protocol version2 is similar to IGMP Protocol version3. Current firmware supports MLDv1/MLDv2.

The IPv6 multicast hosts can join or leave from multicast group at any location, any time, regardless of the



total number of group members. It is unnecessary and impossible for multicast switch to store the relationship among all host members. Multicast switch simply finds out via MLD protocol if there are receivers of certain multicast group on the network segment connected to each port. The only thing host need to do is to keep the record of which multicast groups it joined.

MLD is unsymmetrical between host and switch: the host needs to respond the MLD query message of multicast switch with membership report message; the switch periodically sends membership query message and determines if there is host joining a specific group in its sub networks according to the response message received, and after it receives the report of a host quitting from the group, it sends out the query for the group to confirm if there is no member left in it.

There are three types of protocol messages of MLD Protocol, that is, Query, Report and Done (which is corresponding to Leave of IGMPv2). Like IGMPv2, the Query messages include General Query and Specific Group Query. General Query uses the multicast address FF02::1 of hosts as destination address, the group address is 0; and Specific Group Query use its group address as destination address. The multicast addresses of MLD use 130, 131 and 132 as data types denoting the three kinds of messages mentioned above. Other logic is basically same as IGMPv2.

MLD protocol version2 use FF02::16 as destination address of membership report, and 143 as data type. The other logic of MLD Protocol version2 is similar to IGMP Protocol version3.

## 49.6.2 MLD Configuration Task List

- 1、Start MLD (Required)
- 2、Configure MLD auxiliary parameters (Required)
  - (1) Configure MLD group parameters
    - 1) Configure MLD group filter conditions
  - (2) Configure MLD query parameters
    - 1) Configure the interval of MLD sending query message
    - 2) Configure the maximum response time of MLD query
    - 3) Configure overtime of MLD query
- 3、Shut down MLD Protocol

### 1. Start MLD Protocol

There is no special command for starting MLD Protocol on EDGECORE series layer 3 switches. MLD Protocol will automatically start up as long as any IPv6 multicast protocol is started on corresponding interface.

Command	Explanation
Global Mode	
<b>ipv6 pim multicast-routing</b>	To start Global IPv6 Multicast Protocol, the precondition of starting MLD Protocol. The NO operation of corresponding command shuts ipv6 multicast protocol and MLD Protocol. (Required)

Command	Explanation
Port Configuration Mode	

<b>ipv6 pim dense-mode   ipv6 pim sparse-mode</b>	Start MLD Protocol. The NO operation of corresponding command shuts MLD Protocol. (Required)
---	--

## 2. Configure MLD auxiliary parameters

### (1) Configure MLD group parameters

- 1) Configure MLD group filter conditions

Command	Explanation
Port Configuration Mode	
<b>ipv6 mld access-group &lt;acl_name&gt;</b> <b>no ipv6 mld access-group</b>	Configure the filter conditions of interface for MLD group; the NO operation of this command cancels filter conditions.

### (2) Configure MLD Query parameters

- 1) Configure interval time for MLD to send query messages
- 2) Configure the maximum response time of MLD query
- 3) Configure the overtime of MLD query

Command	Explanation
Port Configuration Mode	
<b>ipv6 mld query-interval &lt;time_val&gt;</b> <b>no ipv6 mld query-interval</b>	Configure the interval of MLD query messages sent periodically; the NO operation of this command restores the default value.
<b>ipv6 mld query-max-response-time &lt;time_val&gt;</b> <b>no ipv6 mld query-max-response-time</b>	Configure the maximum response time of the interface for MLD query; the NO operation of this command restores the default value.
<b>ipv6 mld query-timeout &lt;time_val&gt;</b> <b>no ipv6 mld query-timeout</b>	Configure the overtime of the interface for MLD query; the NO operation of this command restores the default value.

## 3. Shut down MLD Protocol

Command	Explanation
Port Configuration Mode	
<b>no ipv6 pim dense-mode   no ipv6 pim sparse-mode   no ipv6 pim multicast-routing (Global Mode)</b>	Shut down MLD Protocol

## 49.6.3 MLD Typical Application

As shown in the following figure, add the Ethernet interfaces of Switch A and Switch B to corresponding vlan, and start PIM6 on each vlan interface.

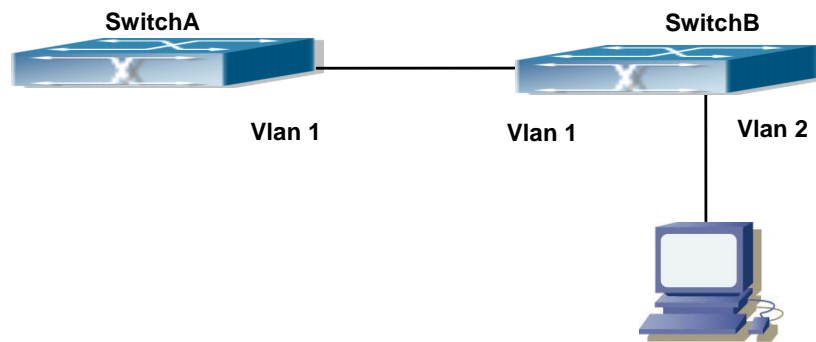

**Figure 49-5** Network Topology Diagram

The configuration procedure for SwitchA and SwitchB is as below:

**(1) Configure SwitchA:**

```
Switch (config) #ipv6 pim multicast-routing
Switch (config) #ipv6 pim rp-address 3FFE::1
Switch (config) #interface vlan 1
Switch (Config-if-Vlan1) #ipv6 address 3FFE::1/64
Switch (Config-if-Vlan1) #ipv6 pim sparse-mode
```

**(2) Configure SwitchB:**

```
Switch (config) #ipv6 pim multicast-routing
Switch (config) #ipv6 pim rp-address 3FFE::1
Switch (config) #interface vlan1
Switch (Config-if-Vlan1) #ipv6 address 3FFE::2/64
Switch (Config-if-Vlan1) #ipv6 pim sparse-mode
Switch (Config-if-Vlan1) #exit
Switch (config) #interface vlan2
Switch (Config-if-Vlan2) #ipv6 address 3FFA::1/64
Switch (Config-if-Vlan2) #ipv6 pim sparse-mode
Switch (Config-if-Vlan2) #ipv6 mld query-timeout 150
```

### 49.6.4 MLD Troubleshooting Help

When configuring and using MLD protocol, MLD protocol may fail to work normally due to physical connections, incorrect configuration and so on. So, users shall note the following points:

- Assure the physical connection is correct.
- Assure the protocol of interface and link is UP (use show interface command)
- Assure to start one kind of multicast protocol on the interface
- Assure the time of the timers of each router on the same network segment is consistent; usually we recommend the default setting.
- Unicast route shall be used to carry out RPF examination for multicast protocol. So the correctness of unicast route shall be guaranteed above all.

---

If all attempts fail to solve the problems on MLD, please use debug commands such as debug ipv6 MLD event/packet, and copy DEBUG information in 3 minutes and send to Technology Service Center.

## 49.7 MLD Snooping

### 49.7.1 Introduction to MLD Snooping

MLD, the Multicast Listener Discovery Protocol, is used to realize multicasting in the IPv6. MLD is used by the network equipments such as routers which supports multicast for multicast listener discovery, also used by listeners looking forward to join certain multicast group informing the router to receive data packets from certain multicast address, all of which are done through MLD message exchange. First the router send an MLD Multicast listener Query message through a multicast address which can address all the listeners (namely ff02::1). Once there is a listener who wishes to join the multicast address, it will send a MLD Multicast listener Report back through the multicast address.

MLD Snooping is namely the MLD listening. The switch restricts the multicast traffic from flooding through MLD Snooping, and forward the multicast traffic to ports associated to multicast devices only. The switch listens to the MLD messages between multicast routers and listeners, and maintains the multicast group forwarding list based on the listening result. The switches forwards multicast packets according to the multicast forwarding list

The switch realizes the MLD Snooping function while supporting MLD v2. This way, the user can acquire IPv6 multicast with the switch.

### 49.7.2 MLD Snooping Configuration Task

1. Enable the MLD Snooping function
2. Configure the MLD Snooping

#### 1. Enable the MLD Snooping function

Command	Explanation
Global Mode	
<b>ipv6 mld snooping</b> <b>no ipv6 mld snooping</b>	Enable global MLD Snooping, the “ <b>no ipv6 mld snooping</b> ” command disables the global MLD snooping.

#### 2. Configure MLD Snooping

Command	Explanation
Global Mode	
<b>ipv6 mld snooping vlan &lt;vlan-id&gt;</b> <b>no ipv6 mld snooping vlan &lt;vlan-id&gt;</b>	Enable MLD Snooping on specific VLAN. The “no” form of this command disables MLD Snooping on specific VLAN.

<b>ipv6 mld snooping vlan &lt;vlan-id&gt; limit</b> <b>{group &lt;g_limit&gt;   source &lt;s_limit&gt;}</b> <b>no ipv6 mld snooping vlan &lt;vlan-id&gt; limit</b>	Configure the number of the groups in which the MLD Snooping can join, and the maximum number of sources in each group. The “no” form of this command restores to the default.
<b>ipv6 mld snooping vlan &lt;vlan-id&gt;</b> <b>I2-general-querier</b> <b>no ipv6 mld snooping vlan &lt;vlan-id&gt;</b> <b>I2-general-querier</b>	Set the VLAN level 2 general querier, which is recommended on each segment. The “no” form of this command cancels the level 2 general querier configuration.
<b>ipv6 mld snooping vlan &lt;vlan-id&gt;</b> <b>mrouter-port interface &lt;interface -name&gt;</b> <b>no ipv6 mld snooping vlan &lt;vlan-id&gt;</b> <b>mrouter-port interface &lt;interface -name&gt;</b>	Configure the static mrouter port in specific vlan. The “no” form of this command cancels the mrouter port configuration.
<b>ipv6 mld snooping vlan &lt;vlan-id&gt;</b> <b>mrouter-port learnpim6</b> <b>no ipv6 mld snooping vlan &lt;vlan-id&gt;</b> <b>mrouter-port learnpim6</b>	Enable the function that the specified VLAN learns mrouter-port (according to pimv6 packets), the no command will disable the function.
<b>ipv6 mld snooping vlan &lt;vlan-id&gt; mrpt</b> <b>&lt;value&gt;</b> <b>no ipv6 mld snooping vlan &lt;vlan-id&gt; mrpt</b>	Configure the keep-alive time of the mrouter port. The “no” form of this command restores to the default.
<b>ipv6 mld snooping vlan &lt;vlan-id&gt;</b> <b>query-interval &lt;value&gt;</b> <b>no ipv6 mld snooping vlan &lt;vlan-id&gt;</b> <b>query-interval</b>	Configure the query interval. The “no” form of this command restores to the default.
<b>ipv6 mld snooping vlan &lt;vlan-id&gt;</b> <b>immediate-leave</b> <b>no ipv6 mld snooping vlan &lt;vlan-id&gt;</b> <b>immediate-leave</b>	Configure immediate leave multicast group function for the MLD Snooping of specific VLAN. The “no” form of this command cancels the immediate leave configuration.
<b>ipv6 mld snooping vlan &lt;vlan-id&gt;</b> <b>query-mrsp &lt;value&gt;</b> <b>no ipv6 mld snooping vlan &lt;vlan-id&gt;</b> <b>query-mrsp</b>	Configure the query maximum response period. The “no” form of this command restores to the default.
<b>ipv6 mld snooping vlan &lt;vlan-id&gt;</b> <b>query-robustness &lt;value&gt;</b> <b>no ipv6 mld snooping vlan &lt;vlan-id&gt;</b> <b>query-robustness</b>	Configure the query robustness, the “no” form of this command restores to the default.
<b>ipv6 mld snooping vlan &lt;vlan-id&gt;</b> <b>suppression-query-time &lt;value&gt;</b> <b>no ipv6 mld snooping vlan &lt;vlan-id&gt;</b>	Configure the suppression query time. The “no” form of this command restores to the default

<b>suppression-query-time</b>	
<b>ipv6 mld snooping vlan &lt;vlan-id&gt;</b> <b>static-group &lt;X:X::X:X&gt; [source &lt;X:X::X:X&gt;]</b> <b>interface [ethernet   port-channel]</b> <b>&lt;IFNAME&gt;</b> <b>no ipv6 mld snooping vlan &lt;vlan-id&gt;</b> <b>static-group &lt;X:X::X:X&gt; [source &lt;X:X::X:X&gt;]</b> <b>interface [ethernet   port-channel]</b> <b>&lt;IFNAME&gt;</b>	Configure static-group on specified port of the VLAN. The no form of the command cancels this configuration.

### 49.7.3 MLD Snooping Examples

#### Scenario 1: MLD Snooping Function

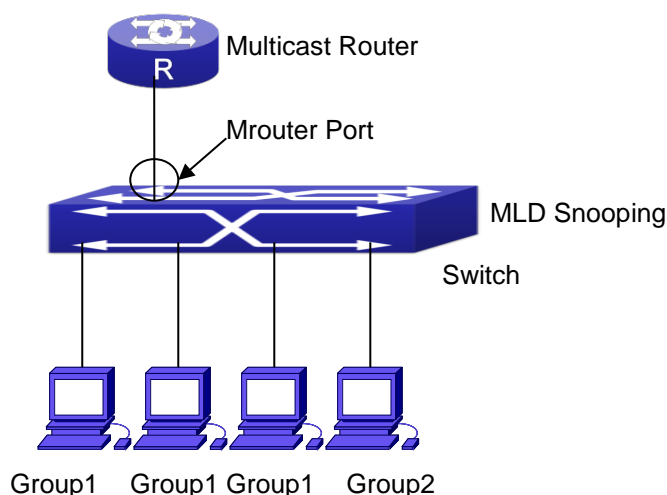

**Figure 49-6** Open the switch MLD Snooping Function figure

As shown above, the vlan 100 configured on the switch consists of ports 1, 2, 6, 10, 12. Four hosts are respectively connected to 2, 6, 10, 12 while the multicast router on port 1. Suppose we need MLD Snooping on VLAN 100, however by default, the global MLD Snooping as well as the MLD Snooping on each VLAN are, therefore first we have to enable the global MLD Snooping at the same time enable the MLD Snooping on VLAN 100, furthermore we need to set the port 1 of VLAN 100 as a mrouter port.

Configuration procedure is as follows.

```
Switch#config
Switch(config)#ipv6 mld snooping
Switch(config)#ipv6 mld snooping vlan 100
Switch(config)#ipv6 mld snooping vlan 100 mrouter-port interface ethernet 1/0/1
```

Multicast configuration:

Assume there are two multicast servers: the Multicast Server 1 and the Multicast Server 2, amongst program 1 and 2 are supplied on the Multicast Server 1 while program 3 on the Multicast server 2, using group

addresses respectively the Group 1, Group 2 and Group 3. Concurrently multicast application is operating on the four hosts. Two hosts connected to port 2 and 5 are playing program 1 while the host connected to port 10 playing program 2, and the one to port 12 playing program 3.

**MLD Snooping interception results:**

The multicast table on vlan 100 shows: port1, 2 and 6 are in ( Multicasting Server 1, Group1 ) , port1, 10 are in (Multicasting Server 1,Group2), and port1, 12 are in (Multicasting Server 2, Group3)

All the four hosts successfully receive programs they are interested in. port2, 6 receives no traffic from program2 and 3; port10 receives no traffic from program 1 and 3, and port12 receives no traffic from program1 and 2.

**Scenario 2: MLD L2-general-querier**

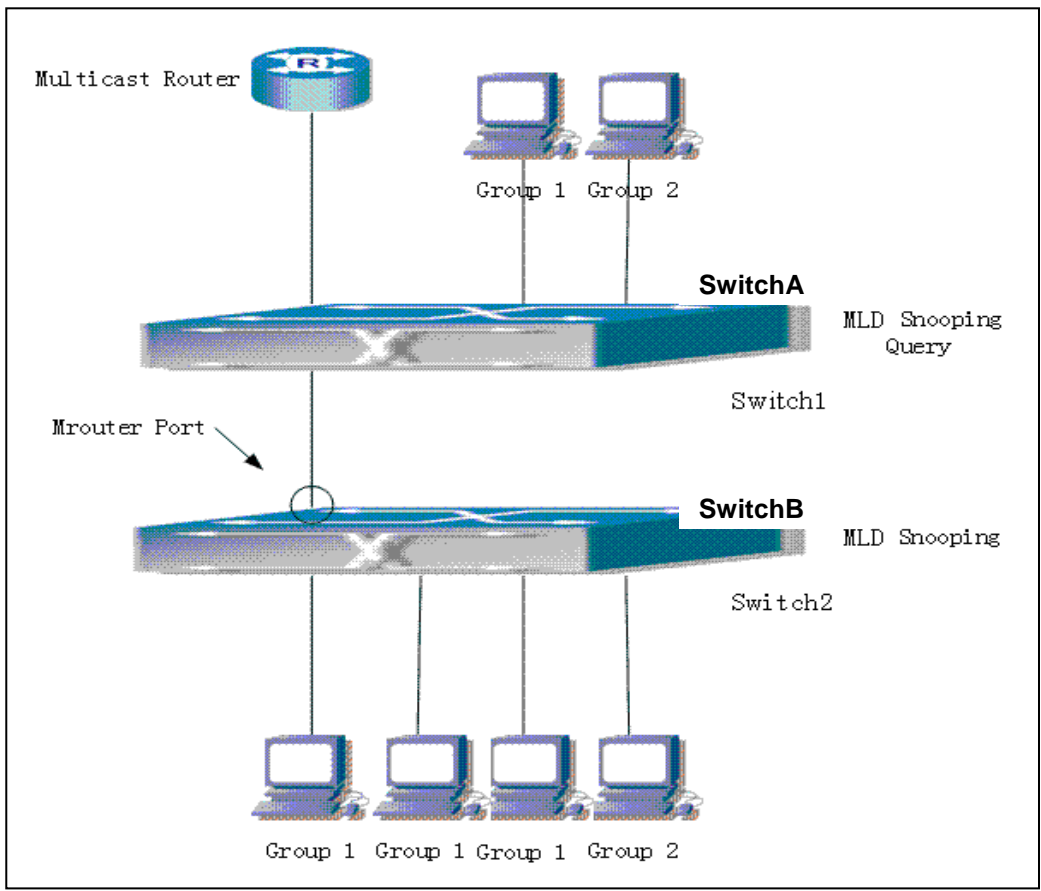

**Figure 49-7** Switch as MLD Querier Function figure

Configuration of switch B is the same as the switches in case 1, and here the switch 1 replaces the Multicast Router in case 1. Assume the vlan 60 configured on it contains port 1, 2, 10, 12, amongst port 1 is connected to multicast server, port 2 to switch2. To send Query periodically, global MLD Snooping has to be enabled while executing the mld snooping vlan 60 l2-general-querier, setting the vlan 60 to a Level 2 General Querier. Configuration procedure is as follows:

```
SwitchA#config
SwitchA(config)#ipv6 mld snooping
SwitchA(config)#ipv6 mld snooping vlan 60
```

```
SwitchA(config)#ipv6 mld snooping vlan 60 l2-general-querier
SwitchB#config
SwitchB(config)#ipv6 mld snooping
SwitchB(config)#ipv6 mld snooping vlan 100
SwitchB(config)#ipv6 mld snooping vlan 100 mrouter interface ethernet 1/0/1
```

Multicast configuration:

Same as scenario 1

**MLD Snooping** interception results:

Same as scenario 1

### **Scenario 3: To run in cooperation with layer 3 multicast protocols**

SWITCH which is used in Scenario 1 is replaced with ROUTER with specific configurations remains the same. And multicast and IGMP snooping configurations are the same with what it is in Scenario 1. To configure PIM-SM6 on ROUTER, and enable PIM-SM6 on vlan 100 (use the same PIM mode with the connected multicast router), the configurations are listed as below:

```
switch#config
switch(config)#ipv6 pim multicast-routing
switch(config)#interface vlan 100
switch(config-if-vlan100)#ipv6 pim sparse-mode
```

MLD snooping does not distribute entries when layer 3 multicast protocol is enabled. It only does the following tasks.

- To remove the layer 2 multicast entries.
- To provide query functions to the layer 3 with vlan, S, and G as the parameters.
- When layer 3 MLD is disabled, re-enable distributing layer 2 multicast entries.

By looking up the layer 3 IP6MC entries, it can be found that ports can be indicated by the layer 3 multicast entries. This ensures the MLD Snooping can work in cooperation with the layer 3 multicast protocols.

## **49.7.4 MLD Snooping Troubleshooting**

In configuring and using MLD Snooping, the MLD Snooping server may fail to run properly due to physical connection failure, wrong configuration, etc. The user should ensure the following:

- Ensure the physical connection is correct
- Ensure the MLD Snooping is enabled under global mode (using ipv6 mld snooping)
- Ensure the MLD Snooping is configured on the vlan under global mode (using ipv6 mld snooping vlan <vlan-id> )
- Ensure there is a vlan configured as a L2 general querier, or there is a static mrouter configured in a segment,
- Use command to check if the MLD snooping information is correct



---

# Chapter 50 Multicast VLAN

## 50.1 Introductions to Multicast VLAN

Based on current multicast order method, when orders from users in different VLAN, each VLAN will copy a multicast traffic in this VLAN, which is a great waste of the bandwidth. By configuration of the multicast VLAN, we add the switch port to the multicast VLAN, with the IGMP Snooping/MLD Snooping functions enabled, users from different VLAN will share the same multicast VLAN. The multicast traffic only exists within a multicast VLAN, so the bandwidth is saved. As the multicast VLAN is absolutely separated from the user VLAN, security and bandwidth concerns can be met at the same time, after the multicast VLAN is configured, the multicast traffic will be continuously sent to the users.

## 50.2 Multicast VLAN Configuration Task List

- 1 · Enable the multicast VLAN function
- 2 · Configure the IGMP Snooping
- 3 · Configure the MLD Snooping

### 1. Enable the multicast VLAN function

Command	Explanation
VLAN configuration mode	
<b>multicast-vlan</b> <b>no multicast-vlan</b>	Configure a VLAN and enable the multicast VLAN on it. The " <b>no multicast-vlan</b> " command disables the multicast function on the VLAN.
<b>multicast-vlan association &lt;vlan-list&gt;</b> <b>no multicast-vlan association &lt;vlan-list&gt;</b>	Associate a multicast VLAN with several VLANs. The "no" form of this command deletes the related VLANs associated with the multicast VLAN.

### 2. Configure the IGMP Snooping

Command	Explanation
Global Mode	
<b>ip igmp snooping vlan &lt;vlan-id&gt;</b> <b>no ip igmp snooping vlan &lt;vlan-id&gt;</b>	Enable the IGMP Snooping function on the multicast VLAN. The "no" form of this command disables the IGMP Snooping on the multicast VLAN.
<b>ip igmp snooping</b> <b>no ip igmp snooping</b>	Enable the IGMP Snooping function. The "no" form of this command disables the IGMP snooping function.

### 3. Configure the MLD Snooping

Command	Explanation
Global Mode	
<b>ipv6 mld snooping vlan &lt;vlan-id&gt;</b> <b>no ipv6 mld snooping vlan &lt;vlan-id&gt;</b>	Enable MLD Snooping on multicast VLAN; the “no” form of this command disables MLD Snooping on multicast VLAN.
<b>ipv6 mld snooping</b> <b>no ipv6 mld snooping</b>	Enable the MLD Snooping function. The “no” form of this command disables the MLD snooping function.

## 50.3 Multicast VLAN Examples

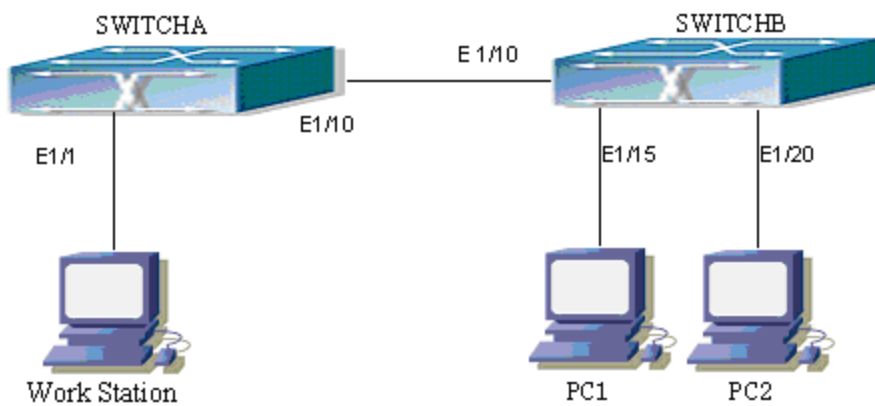

**Figure 50-1** Function configuration of the Multicast VLAN

As shown in the figure, the multicast server is connected to the layer 3 switch switchA through port 1/1 which belongs to the VLAN10 of the switch. The layer 3 switch switchA is connected with layer 2 switches through the port1/10, which configured as trunk port. On the switchB the VLAN100 is configured set to contain port1/15, and VLAN101 to contain port1/20. PC1 and PC2 are respectively connected to port 1/15 and1/20. The switchB is connected with the switchA through port1/10, which configured as trunk port. VLAN 20 is a multicast VLAN. By configuring multicast vlan, the PC1 and PC2 will receives the multicast data from the multicast VLAN.

Following configuration is based on the IP address of the switch has been configured and all the equipment are connected correctly.

#### Configuration procedure

```
SwitchA#config
SwitchA(config)#vlan 10
SwitchA(config-vlan10)#switchport access ethernet 1/0/1
SwitchA(config-vlan10)exit
```

```
SwitchA(config)#interface vlan 10
Switch(Config-if-Vlan10)#ip pim dense-mode
Switch(Config-if-Vlan10)#exit
SwitchA(config)#vlan 20
SwitchA(config-vlan20)#exit
SwitchA(config)#interface vlan 20
SwitchA(Config-if-Vlan20)#ip pim dense-mode
SwitchA(Config-if-Vlan20)#exit
SwitchA(config)#ip pim multicast
SwitchA(config)# interface ethernet1/0/10
SwitchA(Config-If-Ethernet1/0/10)switchport mode trunk
```

```
SwitchB#config
SwitchB(config)#vlan 100
SwitchB(config-vlan100)#Switchport access ethernet 1/0/15
SwitchB(config-vlan100)exit
SwitchB(config)#vlan 101
SwitchB(config-vlan101)#Switchport access ethernet 1/0/20
SwitchB(config-vlan101)exit
SwitchB(config)# interface ethernet 1/0/10
SwitchB(Config-If-Ethernet1/0/10)#Switchport mode trunk
SwitchB(Config-If-Ethernet1/0/10)#exit
SwitchB(config)#vlan 20
SwitchB(config-vlan20)#multicast-vlan
SwitchB(config-vlan20)#multicast-vlan association 100,101
SwitchB(config-vlan20)#exit
SwitchB(config)#ip igmp snooping
SwitchB(config)#ip igmp snooping vlan 20
```

When the multicast VLAN supports the IPv6 multicast, the usage is the same with IPv4, but the difference is using with MLD Snooping, so does not give an example.

---

# Chapter 51 ACL Configuration

## 51.1 Introduction to ACL

ACL (Access Control List) is an IP packet filtering mechanism employed in switches, providing network traffic control by granting or denying access the switches, effectively safeguarding the security of networks. The user can lay down a set of rules according to some information specific to packets, each rule describes the action for a packet with certain information matched: “permit” or “deny”. The user can apply such rules to the incoming direction of switch ports, so that data streams in the incoming direction of specified ports must comply with the ACL rules assigned.

### 51.1.1 Access-list

Access-list is a sequential collection of conditions that corresponds to a specific rule. Each rule consist of filter information and the action when the rule is matched. Information included in a rule is the effective combination of conditions such as source IP, destination IP, IP protocol number and TCP port, UDP port. Access-lists can be categorized by the following criteria:

- Filter information based criterion: IP access-list (layer 3 or higher information), MAC access-list (layer 2 information), and MAC-IP access-list (layer 2 or layer 3 or higher).
- Configuration complexity based criterion: standard and extended, the extended mode allows more specific filtering of information.
- Nomenclature based criterion: numbered and named.

Description of an ACL should cover the above three aspects.

### 51.1.2 Access-group

When a set of access-lists are created, they can be applied to traffic of incoming direction on all ports. Access-group is the description to the binding of an access-list to the incoming direction on a specific port. When an access-group is created, all packets from in the incoming direction through the port will be compared to the access-list rule to decide whether to permit or deny access.

The current firmware only supports ingress ACL configuration.

### 51.1.3 Access-list Action and Global Default Action

There are two access-list actions and default actions: “permit” or “deny”. The following rules apply:

- An access-list can consist of several rules. Filtering of packets compares packet conditions to the rules, from the first rule to the first matched rule; the rest of the rules will not be processed. Global default action applies only to IP packets in the incoming direction on the ports.
- Global default action applies only when packet flirter is enabled on a port and no ACL is bound to that port, or no binding ACL matches.

---

## 51.2 ACL Configuration Task List

ACL Configuration Task Sequence:

1. Configuring access-list
  - (1) Configuring a numbered standard IP access-list
  - (2) Configuring a numbered extended IP access-list
  - (3) Configuring a standard IP access-list based on nomenclature
    - a) Create a standard IP access-list based on nomenclature
    - b) Specify multiple “permit” or “deny” rule entries.
    - c) Exit ACL Configuration Mode
  - (4) Configuring an extended IP access-list based on nomenclature.
    - a) Create an extensive IP access-list based on nomenclature
    - b) Specify multiple “permit” or “deny” rule entries
    - c) Exit ACL Configuration Mode
  - (5) Configuring a numbered standard MAC access-list
  - (6) Configuring a numbered extended MAC access-list
  - (7) Configuring a extended MAC access-list based on nomenclature
    - a) Create a extensive MAC access-list based on nomenclature
    - b) Specify multiple “permit” or “deny” rule entries.
    - c) Exit ACL Configuration Mode
  - (8) Configuring a numbered extended MAC-IP access-list
  - (9) Configuring a extended MAC-IP access-list based on nomenclature
    - a) Create a extensive MAC-IP access-list based on nomenclature
    - b) Specify multiple “permit” or “deny” rule entries.
    - c) Exit MAC-IP Configuration Mode
  - (10) Configuring a numbered standard IPV6 access-list
  - (11) Configuring a numbered extended IPV6access-list
  - (12) Configuring a standard IPV6 access-list based on nomenclature
    - a) Create a standard IPV6 access-list based on nomenclature
    - b) Specify multiple permit or deny rule entries
    - c) Exit ACL Configuration Mode
  - (13) Configuring an extended IPV6 access-list based on nomenclature.
    - a) Create an extensive IPV6 access-list based on nomenclature
    - b) Specify multiple permit or deny rule entries.
    - c) Exit ACL Configuration Mode
2. Configuring the packet filtering function
  - (2) Enable global packet filtering function
  - (3) Configure default action.
3. Configuring time range function
  - (4) Create the name of the time range
  - (5) Configure periodic time range
  - (6) Configure absolute time range
4. Bind access-list to a incoming direction of the specified port

---

## 5. Clear the filtering information of the specified port

### 1. Configuring access-list

- (1) Configuring a numbered standard IP access-list
- (2) Configuring a numbered extended IP access-list
- (3) Configuring a standard IP access-list based on nomenclature
  - a) Create a standard IP access-list based on nomenclature
  - b) Specify multiple "permit" or "deny" rule entries
  - c) Exit ACL Configuration Mode
- (4) Configuring an extended IP access-list based on nomenclature
  - a) Create an extensive IP access-list based on nomenclature
  - b) Specify multiple "permit" or "deny" rule entries
  - c) Exit ACL Configuration Mode
- (5) Configuring a numbered standard MAC access-list
- (6) Configuring a numbered extended MAC access-list
- (7) Configuring a extended MAC access-list based on nomenclature
  - a) Create a extensive MAC access-list based on nomenclature
  - b) Specify multiple "permit" or "deny" rule entries
  - c) Exit ACL Configuration Mode
- (8) Configuring a numbered extended MAC-IP access-list
- (9) Configuring a extended MAC-IP access-list based on nomenclature
  - a) Create a extensive MAC-IP access-list based on nomenclature
  - b) Specify multiple "permit" or "deny" rule entries
  - c) Exit MAC-IP Configuration Mode
- (10) Configuring a numbered standard IPv6 access-list
- (11) Configuring a numbered extended IPv6 access-list
- (12) Configuring a standard IPv6 access-list based on nomenclature
  - a) Create a standard IPv6 access-list based on nomenclature
  - b) Specify multiple permit or deny rule entries
  - c) Exit ACL Configuration Mode
- (13) Configuring an extended IPv6 access-list based on nomenclature.
  - a) Create an extensive IPv6 access-list based on nomenclature
  - b) Specify multiple permit or deny rule entries
  - c) Exit ACL Configuration Mode

### 2. Configuring the packet filtering function

- (1) Enable global packet filtering function
- (2) Configure default action

### 3. Configuring time range function

- (1) Create the name of the time range
- (2) Configure periodic time range
- (3) Configure absolute time range

### 4. Bind access-list to an incoming direction of the specified port

5. Clear the filtering information of the specified port

## 1. Configuring access-list

### (1) Configuring a numbered standard IP access-list

Command	Explanation
Global Mode	
<pre>access-list &lt;num&gt; {deny   permit} {{&lt;slpAddr&gt; &lt;sMask&gt;}   any-source   {host-source &lt;slpAddr&gt;}} no access-list &lt;num&gt;</pre>	<p>Creates a numbered standard IP access-list, if the access-list already exists, then a rule will add to the current access-list; the “no access-list &lt;num&gt;” command deletes a numbered standard IP access-list.</p>

### (2) Configuring a numbered extensive IP access-list

Command	Explanation
Global Mode	
<pre>access-list &lt;num&gt; {deny   permit} icmp {{&lt;slpAddr&gt; &lt;sMask&gt;}   any-source   {host-source &lt;slpAddr&gt;}} {{&lt;dIpAddr&gt; &lt;dMask&gt;}   any-destination   {host-destination &lt;dIpAddr&gt;}} [&lt;icmp-type&gt; [&lt;icmp-code&gt;]] [precedence &lt;prec&gt;] [tos &lt;tos&gt;][time-range&lt;time-range-name&gt;]</pre>	<p>Creates a numbered ICMP extended IP access rule; if the numbered extended access-list of specified number does not exist, then an access-list will be created using this number.</p>
<pre>access-list &lt;num&gt; {deny   permit} igmp {{&lt;slpAddr&gt; &lt;sMask&gt;}   any-source   {host-source &lt;slpAddr&gt;}} {{&lt;dIpAddr&gt; &lt;dMask&gt;}   any-destination   {host-destination &lt;dIpAddr&gt;}} [&lt;igmp-type&gt;] [precedence &lt;prec&gt;] [tos &lt;tos&gt;][time-range&lt;time-range-name&gt;]</pre>	<p>Creates a numbered IGMP extended IP access rule; if the numbered extended access-list of specified number does not exist, then an access-list will be created using this number.</p>
<pre>access-list &lt;num&gt; {deny   permit} tcp {{&lt;slpAddr&gt; &lt;sMask&gt;}   any-source   {host-source &lt;slpAddr&gt;}} [s-port {&lt;sPort&gt;   range &lt;sPortMin&gt; &lt;sPortMax&gt;}] {{&lt;dIpAddr&gt; &lt;dMask&gt;}   any-destination   {host-destination &lt;dIpAddr&gt;}} [d-port {&lt;dPort&gt;   range &lt;dPortMin&gt; &lt;dPortMax&gt;}] [ack+fin+psh+rst+urg+syn] [precedence &lt;prec&gt;] [tos &lt;tos&gt;][time-range&lt;time-range-name&gt;]</pre>	<p>Creates a numbered TCP extended IP access rule; if the numbered extended access-list of specified number does not exist, then an access-list will be created using this number.</p>

<pre>access-list &lt;num&gt; {deny   permit} udp {{&lt;slpAddr&gt; &lt;sMask&gt;}   any-source   {host-source &lt;slpAddr&gt;}} [s-port {&lt;sPort&gt;   range &lt;sPortMin&gt; &lt;sPortMax&gt;}] {{&lt;dIpAddr&gt; &lt;dMask&gt;}   any-destination   {host-destination &lt;dIpAddr&gt;}} [d-port {&lt;dPort&gt;   range &lt;dPortMin&gt; &lt;dPortMax&gt;}] [precedence &lt;prec&gt;] [tos &lt;tos&gt;][time-range&lt;time-range-name&gt;]</pre>	<p>Creates a numbered UDP extended IP access rule; if the numbered extended access-list of specified number does not exist, then an access-list will be created using this number.</p>
<pre>access-list &lt;num&gt; {deny   permit} {eigrp   gre   igmp   ipinip   ip   ospf   &lt;protocol-num&gt;} {{&lt;slpAddr&gt; &lt;sMask&gt;}   any-source   {host-source &lt;slpAddr&gt;}} {{&lt;dIpAddr&gt; &lt;dMask&gt;}   any-destination   {host-destination &lt;dIpAddr&gt;}} [precedence &lt;prec&gt;] [tos &lt;tos&gt;][time-range&lt;time-range-name&gt;]</pre>	<p>Creates a numbered IP extended IP access rule for other specific IP protocol or all IP protocols; if the numbered extended access-list of specified number does not exist, then an access-list will be created using this number.</p>
<pre>no access-list &lt;num&gt;</pre>	<p>Deletes a numbered extensive IP access-list.</p>

### (3) Configuring a standard IP access-list basing on nomenclature

#### a. Create a name-based standard IP access-list

Command	Explanation
Global Mode	
<pre>ip access-list standard &lt;name&gt; no ip access-list standard &lt;name&gt;</pre>	<p>Creates a standard IP access-list based on nomenclature; the “<b>no ip access-list standard &lt;name&gt;</b>” command deletes the name-based standard IP access-list.</p>

#### b. Specify multiple “permit” or “deny” rules

Command	Explanation
Standard IP ACL Mode	
<pre>[no] {deny   permit} {{&lt;slpAddr&gt; &lt;sMask&gt;}   any-source   {host-source &lt;slpAddr&gt;}}</pre>	<p>Creates a standard name-based IP access rule; the “<b>no</b>” form command deletes the name-based standard IP access rule.</p>



### c. Exit name-based standard IP ACL configuration mode

Command	Explanation
Standard IP ACL Mode	
<b>exit</b>	Exits name-based standard IP ACL configuration mode.

## (4) Configuring an name-based extended IP access-list

### a. Create an extended IP access-list basing on nomenclature

Command	Explanation
Global Mode	
<b>ip access-list extended &lt;name&gt;</b> <b>no ip access-list extended &lt;name&gt;</b>	Creates an extended IP access-list basing on nomenclature; the “ <b>no ip access-list extended &lt;name&gt;</b> ” command deletes the name-based extended IP access-list.

### b. Specify multiple “permit” or “deny” rules

Command	Explanation
Extended IP ACL Mode	
<b>[no] {deny   permit} icmp {{&lt;slpAddr&gt; &lt;sMask&gt;}   any-source   {host-source &lt;slpAddr&gt;}} {{&lt;dIpAddr&gt; &lt;dMask&gt;}   any-destination   {host-destination &lt;dIpAddr&gt;}} [&lt;icmp-type&gt; [&lt;icmp-code&gt;]] [precedence &lt;prec&gt;] [tos &lt;tos&gt;][time-range&lt;time-range-name&gt;]</b>	Creates an extended name-based ICMP IP access rule; the no form command deletes this name-based extended IP access rule.
<b>[no] {deny   permit} igmp {{&lt;slpAddr&gt; &lt;sMask&gt;}   any-source   {host-source &lt;slpAddr&gt;}} {{&lt;dIpAddr&gt; &lt;dMask&gt;}   any-destination   {host-destination &lt;dIpAddr&gt;}} [&lt;igmp-type&gt;] [precedence &lt;prec&gt;] [tos &lt;tos&gt;][time-range&lt;time-range-name&gt;]</b>	Creates an extended name-based IGMP IP access rule; the no form command deletes this name-based extended IP access rule.
<b>[no] {deny   permit} tcp {{&lt;slpAddr&gt; &lt;sMask&gt;}   any-source   {host-source &lt;slpAddr&gt;}} [s-port {&lt;sPort&gt;   range &lt;sPortMin&gt; &lt;sPortMax&gt;}] {{&lt;dIpAddr&gt; &lt;dMask&gt;}   any-destination   {host-destination &lt;dIpAddr&gt;}} [d-port {&lt;dPort&gt;   range &lt;dPortMin&gt; &lt;dPortMax&gt;}]</b>	Creates an extended name-based TCP IP access rule; the no form command deletes this name-based extended IP access rule.

[ack+fin+psh+rst+urg+syn] [precedence <prec>] [tos <tos>][time-range<time-range-name>]	
[no] {deny   permit} udp {{<slpAddr> <sMask>}   any-source   {host-source <slpAddr>}} [s-port {<sPort>   range <sPortMin> <sPortMax>}] {{<dIpAddr> <dMask>}   any-destination   {host-destination <dIpAddr>}} [d-port {<dPort>   range <dPortMin> <dPortMax>}] [precedence <prec>] [tos <tos>][time-range<time-range-name>]	Creates an extended name-based UDP IP access rule; the no form command deletes this name-based extended IP access rule.
[no] {deny   permit} {eigrp   gre   igmp   ipinip   ip   ospf   <protocol-num>} {{<slpAddr> <sMask>}   any-source   {host-source <slpAddr>}} {{<dIpAddr> <dMask>}   any-destination   {host-destination <dIpAddr>}} [precedence <prec>] [tos <tos>][time-range<time-range-name>]	Creates an extended name-based IP access rule for other IP protocols; the no form command deletes this name-based extended IP access rule.

### c. Exit extended IP ACL configuration mode

Command	Explanation
Extended IP ACL Mode	
exit	Exits extended name-based IP ACL configuration mode.

### (5) Configuring a numbered standard MAC access-list

Command	Explanation
Global Mode	
access-list<num>{deny permit}{any-source-mac {host-source-mac<host_smac>}}{<smac><smac-mask>} } no access-list <num>	Creates a numbered standard MAC access-list, if the access-list already exists, then a rule will add to the current access-list; the “no access-list <num>” command deletes a numbered standard MAC access-list.

### (6) Creates a numbered MAC extended access-list

Command	Explanation
Global Mode	

<pre> access-list&lt;num&gt; {deny permit} {any-source-mac  {host-source-mac&lt;host_smac&gt;}{&lt;smac&gt;&lt;smac-ma sk&gt;}}{any-destination-mac {host-destination-mac&lt;h ost_dmac&gt;}{&lt;dmac&gt;&lt;dmac-mask&gt;}}[untagged-eth 2   tagged-eth2   untagged-802-3   tagged-802-3} [ &lt;offset1&gt; &lt;length1&gt; &lt;value1&gt; [ &lt;offset2&gt; &lt;length2&gt; &lt;value2&gt; [ &lt;offset3&gt; &lt;length3&gt; &lt;value3&gt; [ &lt;offset4&gt; &lt;length4&gt; &lt;value4&gt; ]]]]] no access-list &lt;num&gt; </pre>	<p>Creates a numbered MAC extended access-list, if the access-list already exists, then a rule will add to the current access-list; the “no access-list &lt;num&gt;” command deletes a numbered MAC extended access-list.</p>
--	---

**(7) Configuring a extended MAC access-list based on nomenclature**

**a. Create a extensive MAC access-list based on nomenclature**

Command	Explanation
<pre> Global Mode  mac-access-list extended &lt;name&gt; no mac-access-list extended &lt;name&gt; </pre>	<p>Creates an extended name-based MAC access rule for other IP protocols; the “no” form command deletes this name-based extended MAC access rule.</p>

**b. Specify multiple “permit” or “deny” rule entries**

Command	Explanation
<pre> Extended name-based MAC access rule Mode  [no]{deny permit}{any-source-mac {host-source-ma c&lt;host_smac&gt;}{&lt;smac&gt;&lt;smac-mask&gt;}} {any-destination-mac {host-destination-mac &lt;host_dmac&gt;}{&lt;dmac&gt; &lt;dmac-mask&gt;}} [cos &lt;cos-val&gt; [&lt;cos-bitmask&gt;] [vlanId &lt;vid-value&gt; [&lt;vid-mask&gt;][ethertype&lt;protocol&gt;[&lt;protocol-mask&gt;] ]]]  [no]{deny permit} {any-source-mac  {host-source-mac&lt;host_smac&gt;}{&lt;smac&gt;&lt;smac-ma sk&gt;}} {any-destination-mac {host-destination-mac&lt;host_d mac&gt;}{&lt;dmac&gt;&lt;dmac-mask&gt;}} [ethertype &lt;protocol&gt; [&lt;protocol-mask&gt;]] </pre>	<p>Creates an extended name-based MAC access rule matching MAC frame; the no form command deletes this name-based extended MAC access rule.</p>

<pre>[no]{deny permit} {any-source-mac {host-source-mac&lt;host_smac&gt; {&lt;smac&gt;&lt;smac-mask&gt;}} {any-destination-mac  {host-destination-mac&lt;host_dmac&gt; {&lt;dmac&gt;&lt;dmac-mask&gt;}} [vlanid &lt;vid-value&gt; [&lt;vid-mask&gt;][ethertype &lt;protocol&gt; [&lt;protocol-mask&gt;]]]</pre>	
<pre>[no]{deny permit}{any-source-mac {host-source-mac&lt;host_smac&gt; {&lt;smac&gt;&lt;smac-mask&gt;}}{any-destination-mac {host-destination-mac&lt;host_dmac&gt; {&lt;dmac&gt;&lt;dmac-mask&gt;}}[untagged-eth2 [ethertype &lt;protocol&gt; [protocol-mask]]]</pre>	<p>Creates an extended name-based MAC access rule matching untagged ethernet 2 frame; the no form command deletes this name-based extended MAC access rule.</p>
<pre>[no]{deny permit}{any-source-mac {host-source-mac&lt;host_smac&gt; {&lt;smac&gt;&lt;smac-mask&gt;}}{any-destination-mac {host-destination-mac&lt;host_dmac&gt; {&lt;dmac&gt;&lt;dmac-mask&gt;}}[untagged-802-3]</pre>	<p>Creates an MAC access rule matching 802.3 frame; the no form command deletes this MAC access rule.</p>
<pre>[no]{deny permit}{any-source-mac {host-source-mac&lt;host_smac&gt; {&lt;smac&gt;&lt;smac-mask&gt;}}{any-destination-mac {host-destination-mac&lt;host_dmac&gt; {&lt;dmac&gt;&lt;dmac-mask&gt;}}[tagged-eth2 [cos &lt;cos-val&gt; [cos-bitmask]] [vlanid &lt;vid-value&gt; [vid-mask]] [ethertype&lt;protocol&gt; [protocol-mask]]]</pre>	<p>Creates an MAC access rule matching tagged ethernet 2 frame; the no form command deletes this MAC access rule.</p>
<pre>[no]{deny permit}{any-source-mac {host-source-mac&lt;host_smac&gt; {&lt;smac&gt;&lt;smac-mask&gt;}}{any-destination-mac {host-destination-mac&lt;host_dmac&gt; {&lt;dmac&gt;&lt;dmac-mask&gt;}} [tagged-802-3 [cos &lt;cos-val&gt; [cos-bitmask]] [vlanid &lt;vid-value&gt; [vid-mask]]]</pre>	<p>Creates an MAC access rule matching tagged 802.3 frame; the no form command deletes this MAC access rule.</p>

### c. Exit ACL Configuration Mode

Command	Explanation
Extended name-based MAC access configure Mode	
exit	Quit the extended name-based MAC access configure mode.

(8) Configuring a numbered extended MAC-IP access-list

Command	Explanation
Global mode <b>access-list&lt;num&gt;{deny permit} {any-source-mac             {host-source-mac &lt;host_smac&gt;}   {&lt;smac&gt;            &lt;smac-mask&gt;}} {any-destination-mac              {host-destination-mac &lt;host_dmac&gt;}              {&lt;dmac&gt;&lt;dmac-mask&gt;}} icmp {{&lt;source&gt;            &lt;source-wildcard&gt;}  any-source  {host-source            &lt;source-host-ip&gt;}} {{&lt;destination&gt;            &lt;destination-wildcard&gt;}   any-destination              {host-destination &lt;destination-host-ip&gt;}}            [&lt;icmp-type&gt; [&lt;icmp-code&gt;]] [precedence            &lt;precedence&gt;] [tos &lt;tos&gt;] [time-range            &lt;time-range-name&gt;]</b>	Creates a numbered mac-icmp extended mac-ip access rule; if the numbered extended access-list of specified number does not exist, then an access-list will be created using this number.
<b>access-list&lt;num&gt;{deny permit}{any-source-mac             {host-source-mac&lt;host_smac&gt;}}{&lt;smac&gt;&lt;smac-ma            sk&gt;}} {any-destination-mac {host-destination-mac            &lt;host_dmac&gt;}}{&lt;dmac&gt;&lt;dmac-mask&gt;}}igmp            {{&lt;source&gt;&lt;source-wildcard&gt;} any-source             {host-source&lt;source-host-ip&gt;}}            {{&lt;destination&gt;&lt;destination-wildcard&gt;} any-destinati            on  {host-destination&lt;destination-host-ip&gt;}}            [&lt;igmp-type&gt;] [precedence &lt;precedence&gt;] [tos            &lt;tos&gt;][time-range&lt;time-range-name&gt;]</b>	Creates a numbered mac-igmp extended mac-ip access rule; if the numbered extended access-list of specified number does not exist, then an access-list will be created using this number.
<b>access-list&lt;num&gt;{deny permit}{any-source-mac             {host-source-mac&lt;host_smac&gt;}}{&lt;smac&gt;&lt;smac-ma            sk&gt;}}{any-destination-mac {host-destination-mac            &lt;host_dmac&gt;}}{&lt;dmac&gt;&lt;dmac-mask&gt;}}tcp            {{&lt;source&gt;&lt;source-wildcard&gt;} any-source             {host-source&lt;source-host-ip&gt;}} [s-port {&lt;port1&gt;              range &lt;sPortMin&gt; &lt;sPortMax&gt;}]            {{&lt;destination&gt;&lt;destination-wildcard&gt;} any-destinati            on  {host-destination &lt;destination-host-ip&gt;}} [d-port            {&lt;port3&gt;   range &lt;dPortMin&gt; &lt;dPortMax&gt;}]            [ack+fin+psh+rst+urg+syn] [precedence            &lt;precedence&gt;] [tos</b>	Creates a numbered mac-ip extended mac-tcp access rule; if the numbered extended access-list of specified number does not exist, then an access-list will be created using this number.

<pre> &lt;tos&gt;][time-range&lt;time-range-name&gt;] access-list&lt;num&gt;{deny permit}{any-source-mac  {host-source-mac&lt;host_smac&gt;}{&lt;smac&gt;&lt;smac-ma sk&gt;}}{any-destination-mac {host-destination-mac &lt;host_dmac&gt;}{&lt;dmac&gt;&lt;dmac-mask&gt;}}udp {{&lt;source&gt;&lt;source-wildcard&gt;} any-source  {host-source&lt;source-host-ip&gt;}} [s-port {&lt;port1&gt;   range &lt;sPortMin&gt; &lt;sPortMax&gt;}] {{&lt;destination&gt;&lt;destination-wildcard&gt;} any-destinati on  {host-destination&lt;destination-host-ip&gt;}} [d-port {&lt;port3&gt;   range &lt;dPortMin&gt; &lt;dPortMax&gt;}] [precedence &lt;precedence&gt;] [tos &lt;tos&gt;][time-range&lt;time-range-name&gt;] </pre>	<p>Creates a numbered mac-udp extended mac-ip access rule; if the numbered extended access-list of specified number does not exist, then an access-list will be created using this number.</p>
<pre> access-list&lt;num&gt;{deny permit}{any-source-mac  {host-source-mac&lt;host_smac&gt;}{&lt;smac&gt;&lt;smac-ma sk&gt;}} {any-destination-mac {host-destination-mac &lt;host_dmac&gt;}{&lt;dmac&gt;&lt;dmac-mask&gt;}} {eigrp gre igrp ip ipinip ospf {&lt;protocol-num&gt;}} {{&lt;source&gt;&lt;source-wildcard&gt;} any-source  {host-source&lt;source-host-ip&gt;}} {{&lt;destination&gt;&lt;destination-wildcard&gt;} any-destinati on  {host-destination&lt;destination-host-ip&gt;}} [precedence &lt;precedence&gt;] [tos &lt;tos&gt;][time-range&lt;time-range-name&gt;] </pre>	<p>Creates a numbered extended mac-ip access rule for other specific mac-ip protocol or all mac-ip protocols; if the numbered extended access-list of specified number does not exist, then an access-list will be created using this number.</p>
<pre> no access-list &lt;num&gt; </pre>	<p>Deletes this numbered extended MAC-IP access rule.</p>

**(9) Configuring a extended MAC-IP access-list based on nomenclature**

**a. Create a extensive MAC-IP access-list based on nomenclature**

Command	Explanation
Global Mode	
<pre> mac-ip-access-list extended &lt;name&gt; no mac-ip-access-list extended &lt;name&gt; </pre>	<p>Creates an extended name-based MAC-IP access rule; the “no” form command deletes this name-based extended MAC-IP access rule.</p>

b. Specify multiple “permit” or “deny” rule entries

Command	Explanation
<p>Extended name-based MAC-IP access Mode</p> <pre>[no]{deny permit} {any-source-mac {host-source-mac &lt;host_smac&gt; {&lt;smac&gt;&lt;smac-mask&gt;}} {any-destination-mac {host-destination-mac &lt;host_dmac&gt; {&lt;dmac&gt;&lt;dmac-mask&gt;}}icmp {{&lt;source&gt;&lt;source-wildcard&gt;} any-source  {host-source&lt;source-host-ip&gt;}} {{&lt;destination&gt;&lt;destination-wildcard&gt;} any-destinati on  {host-destination &lt;destination-host-ip&gt;}} [&lt;icmp-type&gt; [&lt;icmp-code&gt;]] [precedence &lt;precedence&gt;][tos&lt;tos&gt;][time-range&lt;time-range-na me&gt;]</pre>	<p>Creates an extended name-based MAC-ICMP access rule; the no form command deletes this name-based extended MAC-ICMP access rule.</p>
<pre>[no]{deny permit}{any-source-mac {host-source-ma c &lt;host_smac&gt; {&lt;smac&gt;&lt;smac-mask&gt;}} {any-destination-mac {host-destination-mac &lt;host_dmac&gt; {&lt;dmac&gt;&lt;dmac-mask&gt;}}igmp {{&lt;source&gt;&lt;source-wildcard&gt;} any-source  {host-source&lt;source-host-ip&gt;}} {{&lt;destination&gt;&lt;destination-wildcard&gt;} any-destinati on  {host-destination &lt;destination-host-ip&gt;}} [&lt;igmp-type&gt;] [precedence &lt;precedence&gt;] [tos &lt;tos&gt;][time-range&lt;time-range-name&gt;]</pre>	<p>Creates an extended name-based MAC-IGMP access rule; the no form command deletes this name-based extended MAC-IGMP access rule.</p>
<pre>[no]{deny permit}{any-source-mac {host-source-ma c&lt;host_smac&gt; {&lt;smac&gt;&lt;smac-mask&gt;}} {any-destination-mac {host-destination-mac &lt;host_dmac&gt; {&lt;dmac&gt;&lt;dmac-mask&gt;}}tcp {{&lt;source&gt;&lt;source-wildcard&gt;} any-source  {host-source&lt;source-host-ip&gt;}} [s-port {&lt;port1&gt;   range &lt;sPortMin&gt; &lt;sPortMax&gt;}] {{&lt;destination&gt;&lt;destination-wildcard&gt;} any-destinati on  {host-destination &lt;destination-host-ip&gt;}} [d-port {&lt;port3&gt;   range &lt;dPortMin&gt; &lt;dPortMax&gt;}] [ack+fin+psh+rst+urg+syn] [precedence&lt;precedence&gt;][tos&lt;tos&gt;][time-range&lt;ti me-range-name&gt;]</pre>	<p>Creates an extended name-based MAC-TCP access rule; the no form command deletes this name-based extended MAC-TCP access rule.</p>

<pre>[no]{deny permit}{any-source-mac {host-source-mac&lt;host_smac&gt; {&lt;smac&gt;&lt;smac-mask&gt;}} {any-destination-mac {host-destination-mac&lt;host_dmac&gt; {&lt;dmac&gt;&lt;dmac-mask&gt;}}udp {{&lt;source&gt;&lt;source-wildcard&gt;} any-source  {host-source&lt;source-host-ip&gt;}} [s-port {&lt;port1&gt;   range &lt;sPortMin&gt; &lt;sPortMax&gt;}] {{&lt;destination&gt;&lt;destination-wildcard&gt;} any-destination  {host-destination &lt;destination-host-ip&gt;}} [d-port {&lt;port3&gt;   range &lt;dPortMin&gt; &lt;dPortMax&gt;}] [precedence &lt;precedence&gt;] [tos &lt;tos&gt;][time-range&lt;time-range-name&gt;]</pre>	<p>Creates an extended name-based MAC-UDP access rule; the no form command deletes this name-based extended MAC-UDP access rule.</p>
<pre>[no]{deny permit}{any-source-mac {host-source-mac&lt;host_smac&gt; {&lt;smac&gt;&lt;smac-mask&gt;}} {any-destination-mac {host-destination-mac&lt;host_dmac&gt; {&lt;dmac&gt;&lt;dmac-mask&gt;}} {eigrp gre igrp ip ipinip ospf {&lt;protocol-num&gt;}} {{&lt;source&gt;&lt;source-wildcard&gt;} any-source  {host-source&lt;source-host-ip&gt;}} {{&lt;destination&gt;&lt;destination-wildcard&gt;} any-destination  {host-destination&lt;destination-host-ip&gt;}} [precedence&lt;precedence&gt;][tos&lt;tos&gt;][time-range&lt;time-range-name&gt;]</pre>	<p>Creates an extended name-based access rule for the other IP protocol; the no form command deletes this name-based extended access rule.</p>

### c. Exit MAC-IP Configuration Mode

Command	Explanation
Extended name-based MAC-IP access Mode	
<b>exit</b>	Quit extended name-based MAC-IP access mode.

### (10) Configuring a numbered standard IPV6 access-list

Command	Explanation
Global Mode	
<pre>ipv6 access-list &lt;num&gt; {deny   permit} {{&lt;sIPv6Addr&gt; &lt;sPrefixlen&gt;}   any-source   {host-source &lt;slpv6Addr&gt;}} no ipv6 access-list &lt;num&gt;</pre>	<p>Creates a numbered standard IPV6 access-list, if the access-list already exists, then a rule will add to the current access-list; the "no</p>



	<b>access-list &lt;num&gt;</b> “ command deletes a numbered standard IPv6 access-list.
--	--

(11) Configuring a numbered extensive IPV6 access-list

Command	Explanation
Global Mode	
<b>ipv6 access-list &lt;num-ext&gt; {deny   permit} icmp</b> <b>{{&lt;sIPv6Prefix/sPrefixlen&gt;   any-source  </b> <b>{host-source &lt;sIPv6Addr&gt;}}</b> <b>{&lt;dIPv6Prefix/dPrefixlen&gt;   any-destination  </b> <b>{host-destination &lt;dIPv6Addr&gt;}} [&lt;icmp-type&gt;</b> <b>[&lt;icmp-code&gt;]] [dscp &lt;dscp&gt;] [flow-label</b> <b>&lt;flowlabel&gt;] [time-range &lt;time-range-name&gt;]</b>	Creates a numbered extended IPV6 access-list, if the access-list already exists, then a rule will add to the current access-list; the <b>no ipv6 access-list &lt;num&gt;</b> command deletes a numbered standard IPV6 access-list.
<b>ipv6 access-list &lt;num-ext&gt; {deny   permit} tcp</b> <b>{{&lt;sIPv6Prefix/&lt;sPrefixlen&gt;   any-source  </b> <b>{host-source &lt;sIPv6Addr&gt;}} [s-port { &lt;sPort&gt;   range</b> <b>&lt;sPortMin&gt; &lt;sPortMax&gt; }] {{&lt;</b> <b>dIPv6Prefix/&lt;dPrefixlen&gt;   any-destination  </b> <b>{host-destination &lt;dIPv6Addr&gt;}} [dPort { &lt;dPort&gt;  </b> <b>range &lt;sPortMin&gt; &lt;sPortMax&gt; }] [syn   ack   urg   rst  </b> <b>fin   psh] [dscp &lt;dscp&gt;] [flow-label &lt;flowlabel&gt;]</b> <b>[time-range &lt;time-range-name&gt;]</b>	
<b>ipv6 access-list &lt;num-ext&gt; {deny   permit} udp</b> <b>{{&lt;sIPv6Prefix/&lt;sPrefixlen&gt;   any-source  </b> <b>{host-source &lt;sIPv6Addr&gt;}} [s-port { &lt;sPort&gt;   range</b> <b>&lt;sPortMin&gt; &lt;sPortMax&gt; }]</b> <b>{{&lt;dIPv6Prefix/&lt;dPrefixlen&gt;   any-destination  </b> <b>{host-destination &lt;dIPv6Addr&gt;}} [dPort { &lt;dPort&gt;  </b> <b>range &lt;sPortMin&gt; &lt;sPortMax&gt; }] [dscp &lt;dscp&gt;]</b> <b>[flow-label &lt;flowlabel&gt;] [time-range</b> <b>&lt;time-range-name&gt;]</b>	
<b>ipv6 access-list &lt;num-ext&gt; {deny   permit}</b> <b>&lt;next-header&gt; {&lt;sIPv6Prefix/sPrefixlen&gt;  </b> <b>any-source   {host-source &lt;sIPv6Addr&gt;}}</b> <b>{&lt;dIPv6Prefix/dPrefixlen&gt;   any-destination  </b> <b>{host-destination &lt;dIPv6Addr&gt;}} [dscp &lt;dscp&gt;]</b> <b>[flow-label &lt;flowlabel&gt;] [time-range</b> <b>&lt;time-range-name&gt;]</b>	
<b>no ipv6 access-list &lt;num&gt;</b>	

---

(12) Configuring a standard IPV6 access-list based on nomenclature

a. Create a standard IPV6 access-list based on nomenclature

Command	Explanation
Global Mode	
<b>ipv6 access-list standard &lt;name&gt;</b> <b>no ipv6 access-list standard &lt;name&gt;</b>	Creates a standard IP access-list based on nomenclature; the <b>no</b> command delete the name-based standard IPV6 access-list.

b. Specify multiple permit or deny rules

Command	Explanation
Standard IPV6 ACL Mode	
<b>[no] {deny   permit} {{&lt;sIPv6Prefix/sPrefixlen&gt;}   any-source   {host-source &lt;sIPv6Addr&gt;}}</b>	Creates a standard name-based IPV6 access rule; the <b>no</b> form command deletes the name-based standard IPV6 access rule.

c. Exit name-based standard IP ACL configuration mode

Command	Explanation
Standard IPV6 ACL Mode	
<b>exit</b>	Exits name-based standard IPV6 ACL configuration mode.

(13) Configuring an name-based extended IPV6 access-list

a. Create an extended IPV6 access-list basing on nomenclature

Command	Explanation
Global Mode	
<b>ipv6 access-list extended &lt;name&gt;</b> <b>no ipv6 access-list extended &lt;name&gt;</b>	Creates an extended IPV6 access-list basing on nomenclature; the <b>no</b> command deletes the name-based extended IPV6 access-list.

b. Specify multiple permit or deny rules

Command	Explanation
Extended IPV6 ACL Mode	
[no] {deny   permit} icmp {<sIPv6Prefix/sPrefixlen>   any-source   {host-source <sIPv6Addr>}} {<dIPv6Prefix/dPrefixlen>   any-destination   {host-destination <dIPv6Addr>}} [<icmp-type> [<icmp-code>]] [dscp <dscp>] [flow-label <flowlabel>] [time-range <time-range-name>]	Creates an extended name-based ICMP IPv6 access rule; the no form command deletes this name-based extended IPv6 access rule.
[no] {deny   permit} tcp {<sIPv6Prefix/sPrefixlen>   any-source   {host-source <sIPv6Addr>}} [s-port {<sPort>   range <sPortMin> <sPortMax>}] {<dIPv6Prefix/dPrefixlen>   any-destination   {host-destination <dIPv6Addr>}} [d-port {<dPort>   range <dPortMin> <dPortMax>}] [syn   ack   urg   rst   fin   psh] [dscp <dscp>] [flow-label <fl>] [time-range<time-range-name>]	Creates an extended name-based TCP IPv6 access rule; the no form command deletes this name-based extended IPv6 access rule.
[no] {deny   permit} udp {<sIPv6Prefix/sPrefixlen>   any-source   {host-source <sIPv6Addr>}} [s-port {<sPort>   range <sPortMin> <sPortMax>}] {<dIPv6Prefix/dPrefixlen>   any-destination   {host-destination <dIPv6Addr>}} [d-port {<dPort>   range <dPortMin> <dPortMax>}] [dscp <dscp>] [flow-label <fl>] [time-range<time-range-name>]	Creates an extended name-based UDP IPv6 access rule; the no form command deletes this name-based extended IPv6 access rule.
[no] {deny   permit} <proto> {<sIPv6Prefix/sPrefixlen>   any-source   {host-source <sIPv6Addr>}} {<dIPv6Prefix/dPrefixlen>   any-destination   {host-destination <dIPv6Addr>}} [dscp <dscp>] [flow-label <flowlabel>] [time-range <time-range-name>]	Creates an extended name-based IPv6 access rule for other IPv6 protocols; the no form command deletes this name-based extended IPv6 access rule.
[no] {deny   permit} {<sIPv6Prefix/sPrefixlen>   any-source   {host-source <sIPv6Addr>}} {<dIPv6Prefix/dPrefixlen>   any-destination   {host-destination <dIPv6Addr>}} [dscp <dscp>] [flow-label <flowlabel>] [time-range <time-range-name>]	Creates an extended name-based IPv6 access rule; the no form command deletes this name-based extended IPv6 access rule.

### c. Exit extended IPv6 ACL configuration mode

Command	Explanation
Extended IPV6 ACL Mode	
<b>exit</b>	Exits extended name-based IPV6 ACL configuration mode.

## 2. Configuring packet filtering function

### (1) Enable global packet filtering function

Command	Explanation
Global Mode	
<b>firewall enable</b>	Enables global packet filtering function.
<b>firewall disable</b>	Disables global packet filtering function.

## 3. Configuring time range function

### (1) Create the name of the time range

Command	Explanation
Global Mode	
<b>time-range &lt;time_range_name&gt;</b>	Create a time range named time_range_name.
<b>no time-range &lt;time_range_name&gt;</b>	Stop the time range function named time_range_name.

### (2) Configure periodic time range

Command	Explanation
Time range Mode	
<b>absolute-periodic {Monday   Tuesday   Wednesday   Thursday   Friday   Saturday   Sunday} &lt;start_time&gt; to {Monday   Tuesday   Wednesday   Thursday   Friday   Saturday   Sunday} &lt;end_time&gt;</b>	Configure the time range for the request of the week, and every week will run by the time range.
<b>periodic {{Monday+Tuesday+Wednesday+Thursday+Friday+Saturday+Sunday}   daily   weekdays   weekend} &lt;start_time&gt; to &lt;end_time&gt;</b>	

[no] absolute-periodic {Monday   Tuesday   Wednesday   Thursday   Friday   Saturday   Sunday} <start_time> to {Monday   Tuesday   Wednesday   Thursday   Friday   Saturday   Sunday} <end_time>	Stop the function of the time range in the week.
[no] periodic {{Monday+Tuesday+Wednesday+Thursday+Friday+Saturday+Sunday}   daily   weekdays   weekend} <start_time> to <end_time>	

### (3) Configure absolute time range

Command	Explanation
Global Mode	
absolute start <start_time> <start_data> [end <end_time> <end_data>]	Configure absolute time range.
[no] absolute start <start_time> <start_data> [end <end_time> <end_data>]	Stop the function of the time range.

### 4. Bind access-list to a specific direction of the specified port.

Command	Explanation
Physical Port Mode, VLAN Port Mode	
{ip ipv6 mac mac-ip} access-group <acl-name> {in out} [traffic-statistic] no {ip ipv6 mac mac-ip} access-group <acl-name> {in out}	Apply an access-list to the ingress or egress direction on the port; the no command deletes the access-list bound to the port.

### 5. Clear the filtering information of the specified port

Command	Explanation
Admin Mode	
clear access-group statistic interface { <interface-name>   ethernet <interface-name> }	Clear the filtering information of the specified port.

---

## 51.3 ACL Example

### Scenario 1:

The user has the following configuration requirement: port 1/0/10 of the switch connects to 10.0.0.0/24 segment, ftp is not desired for the user.

### Configuration description:

- 1 · Create a proper ACL
- 2 · Configuring packet filtering function
- 3 · Bind the ACL to the port

### The configuration steps are listed below:

```
Switch(config)#access-list 110 deny tcp 10.0.0.0 0.0.0.255 any-destination d-port 21
Switch(config)#firewall enable
Switch(config)#firewall default permit
Switch(config)#interface ethernet 1/0/10
Switch(Config-If-Ethernet1/0/10)#ip access-group 110 in
Switch(Config-If-Ethernet1/0/10)#exit
Switch(config)#exit
```

### Configuration result:

```
Switch#show firewall
Firewall status: enable.
Firewall default rule: permit.
Switch#show access-lists
access-list 110(used 1 time(s)) 1 rule(s)
access-list 110 deny tcp 10.0.0.0 0.0.0.255 any-destination d-port 21

Switch#show access-group interface ethernet 1/0/10
interface name:Ethernet1/0/10
the ingress acl use in firewall is 110, traffic-statistics Disable.
```

### Scenario 2:

The configuration requirement is stated as below: The switch should drop all the 802.3 datagram with 00-12-11-23-xx-xx as the source MAC address coming from interface 10.

### Configuration description:

- 1 · Create the corresponding access list.
- 2 · Configure datagram filtering.
- 3 · Bind the ACL to the related interface.

**The configuration steps are listed as below.**

```
Switch(config)#access-list 1100 deny 00-12-11-23-00-00 00-00-00-00-ff-ff any-destination-mac
untagged-802-3
Switch(config)#access-list 1100 deny 00-12-11-23-00-00 00-00-00-00-ff-ff any tagged-802
Switch(config)#firewall enable
Switch(config)#firewall default permit
Switch(config)#interface ethernet 1/0/10
Switch(Config-If-Ethernet1/0/10)#mac access-group 1100 in
Switch(Config-If-Ethernet1/0/10)#exit
Switch(config)#exit
```

**Configuration result:**

```
Switch#show firewall
    Firewall Status: Enable.

Switch #show access-lists
access-list 1100(used 1 time(s))
    access-list 1100 deny 00-12-11-23-00-00 00-00-00-00-ff-ff
any-destination-mac
    untagged-802-3
    access-list 1100 deny 00-12-11-23-00-00 00-00-00-00-ff-ff
any-destination-mac
Switch #show access-group interface ethernet 1/0/10
interface name:Ethernet1/0/10
    MAC Ingress access-list used is 1100,traffic-statistics Disable.
```

### **Scenario 3:**

The configuration requirement is stated as below: The MAC address range of the network connected to the interface 10 of the switch is 00-12-11-23-xx-xx, and IP network is 10.0.0.0/24. FTP should be disabled and ping requests from outside network should be disabled.

**Configuration description:**

- 1 · Create the corresponding access list.
- 2 · Configure datagram filtering.
- 3 · Bind the ACL to the related interface.

**The configuration steps are listed as below.**

```
Switch(config)#access-list 3110 deny 00-12-11-23-00-00 00-00-00-00-ff-ff any-destination-mac tcp 10.0.0.0
0.0.0.255 any-destination d-port 21
Switch(config)#access-list 3110 deny any-source-mac 00-12-11-23-00-00 00-00-00-00-ff-ff icmp any-source
10.0.0.0 0.0.0.255

Switch(config)#firewall enable
```

```
Switch(config)#firewall default permit
Switch(config)#interface ethernet 1/0/10
Switch(Config-If-Ethernet1/0/10)#mac-ip access-group 3110 in
Switch(Config-Ethernet1/0/10)#exit
Switch(config)#exit
```

#### Configuration result:

```
Switch#show firewall
  Firewall Status: Enable.

Switch#show access-lists
  access-list 3110(used 1 time(s))
access-list 3110 deny 00-12-11-23-00-00 00-00-00-00-ff-ff
  any-destination-mac
tcp 10.0.0.0 0.0.0.255 any-destination d-port 21
  access-list 3110 deny any-source-mac 00-12-11-23-00-00 00-00-00-00-ff-ff icmp any-source 10.0.0.0
0.0.0.255

Switch #show access-group interface ethernet 1/0/10
interface name:Ethernet1/0/10
  MAC-IP Ingress access-list used is 3110, traffic-statistics Disable.
```

#### Scenario 4:

The configuration requirement is stated as below: IPv6 protocol runs on the interface 600 of the switch. And the IPv6 network address is 2003:1:1:1::0/64. Users in the 2003:1:1:1:66::0/80 subnet should be disabled from accessing the outside network.

#### Configuration description:

- 1 · Create the corresponding access list.
- 2 · Configure datagram filtering.
- 3 · Bind the ACL to the related interface.

The configuration steps are listed as below.

```
Switch(config)#ipv6 access-list 600 permit 2003:1:1:1:66::0/80 any-destination
Switch(config)#ipv6 access-list 600 deny 2003:1:1:1::0/64 any-destination

Switch(config)#firewall enable
Switch(config)#firewall default permit
Switch(config)#interface ethernet 1/0/10
Switch(Config-If-Ethernet1/0/10)#ipv6 access-group 600 in
Switch(Config-If-Ethernet1/0/10)#exit
Switch(config)#exit
```



---

**Configuration result:**

```
Switch#show firewall
Firewall Status: Enable.

Switch#show ipv6 access-lists
IPv6 access-list 600(used 1 time(s))
  IPv6 access-list 600 deny 2003:1:1:1::0/64 any-source
  IPv6 access-list 600 permit 2003:1:1:1:66::0/80 any-source

Switch #show access-group interface ethernet 1/0/10
interface name:Ethernet1/0/10
  IPv6 Ingress access-list used is 600, traffic-statistics Disable.
```

**Scenario 5:**

The configuration requirement is stated as below: The interface 1, 2, 5, 7 belongs to vlan100, Hosts with 192.168.0.1 as its IP address should be disabled from accessing the listed interfaces.

**Configuration description:**

- 1 · Create the corresponding access list.
- 2 · Configure datagram filtering.
- 3 · Bind the ACL to the related interface.

**The configuration steps are listed as below.**

```
Switch (config)#firewall enable
Switch (config)#vlan 100
Switch (Config-Vlan100)#switchport interface ethernet 1/0/1;2;5;7
Switch (Config-Vlan100)#exit
Switch (config)#access-list 1 deny host-source 192.168.0.1
Switch (config)#interface ethernet1/0/1;2;5;7
Switch (config-if-port-range)#ip access-group 1 in
Switch (Config-if-Vlan100)#exit
```

**Configuration result:**

```
Switch (config)#show access-group interface vlan 100
Interface VLAN 100:
Ethernet1/0/1: IP Ingress access-list used is 1, traffic-statistics Disable.
Ethernet1/0/2: IP Ingress access-list used is 1, traffic-statistics Disable.
Ethernet1/0/5: IP Ingress access-list used is 1, traffic-statistics Disable.
Ethernet1/0/7: IP Ingress access-list used is 1, traffic-statistics Disable
```

---

## 51.4 ACL Troubleshooting

- Checking for entries in the ACL is done in a top-down order and ends whenever an entry is matched.
- Each ingress port can bind one MAC-IP ACL, one IP ACL, one MAC ACL, one IPv6 ACL (via the physical interface mode or Vlan interface mode).
- When binding four ACL and packet matching several ACL at the same time, the priority relations are as follows in a top-down order. If the priority is same, then the priority of configuration at first is higher.
  - ◆ Ingress IPv6 ACL
  - ◆ Ingress MAC-IP ACL
  - ◆ Ingress IP ACL
  - ◆ Ingress MAC ACL
- The number of ACLs that can be successfully bound depends on the content of the ACL bound and the hardware resource limit. Users will be prompted if an ACL cannot be bound due to hardware resource limitation.
- If an access-list contains same filtering information but conflicting action rules, binding to the port will fail with an error message. For instance, configuring “permit tcp any any-destination” and “deny tcp any any-destination” at the same time is not permitted.
- Viruses such as “worm.blastar” can be blocked by configuring ACL to block specific ICMP packets or specific TCP or UDP port packet.

# Chapter 52 802.1x Configuration

## 52.1 Introduction to 802.1x

The 802.1x protocol originates from 802.11 protocol, the wireless LAN protocol of IEEE, which is designed to provide a solution to doing authentication when users access a wireless LAN. The LAN defined in IEEE 802 LAN protocol does not provide access authentication, which means as long as the users can access a LAN controlling device (such as a LAN Switch), they will be able to get all the devices or resources in the LAN. There was no looming danger in the environment of LAN in those primary enterprise networks.

However, along with the boom of applications like mobile office and service operating networks, the service providers should control and configure the access from user. The prevailing application of WLAN and LAN access in telecommunication networks, in particular, make it necessary to control ports in order to implement the user-level access control. And as a result, IEEE LAN/WAN committee defined a standard, which is 802.1x, to do Port-Based Network Access Control. This standard has been widely used in wireless LAN and ethernet.

“Port-Based Network Access Control” means to authenticate and control the user devices on the level of ports of LAN access devices. Only when the user devices connected to the ports pass the authentication, can they access the resources in the LAN, otherwise, the resources in the LAN won't be available.

### 52.1.1 The Authentication Structure of 802.1x

The system using 802.1x has a typical Client/Server structure, which contains three entities (as illustrated in the next figure): Supplicant system, Authenticator system, and Authentication server system.

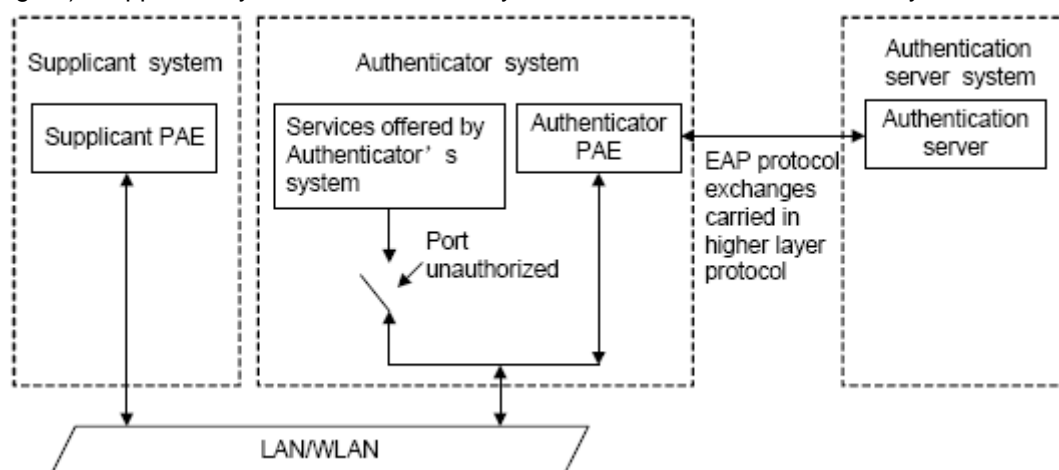

Figure 52-1 The Authentication Structure of 802.1x

- The supplicant system is an entity on one end of the LAN segment, should be authenticated by the access controlling unit on the other end of the link. A Supplicant system usually is a user terminal device. Users start 802.1x authentication by starting supplicant system software. A supplicant

---

system should support EAPOL (Extensible Authentication Protocol over LAN).

- The authenticator system is another entity on one end of the LAN segment to authenticate the supplicant systems connected. An authenticator system usually is a network device supporting 802.1x protocol, providing ports to access the LAN for supplicant systems. The ports provided can either be physical or logical.
- The authentication server system is an entity to provide authentication service for authenticator systems. The authentication server system is used to authenticate and authorize users, as well as does fee-counting, and usually is a RADIUS (Remote Authentication Dial-In User Service) server, which can store the relative user information, including username, password and other parameters such as the VLAN and ports which the user belongs to.

The three entities above concerns the following basic concepts: PAE of the port, the controlled ports and the controlled direction.

### 1. PAE

PAE (Port Access Entity) is the entity to implement the operation of algorithms and protocols.

- The PAE of the supplicant system is supposed to respond the authentication request from the authenticator systems and submit user's authentication information to the authenticator system. It can also send authentication request and off-line request to authenticator.
- The PAE of the authenticator system authenticates the supplicant systems needing to access the LAN via the authentication server system, and deal with the authenticated/unauthenticated state of the controlled port according to the result of the authentication. The authenticated state means the user is allowed to access the network resources, the unauthenticated state means only the EAPOL messages are allowed to be received and sent while the user is forbidden to access network resources.

### 2. controlled/uncontrolled ports

The authenticator system provides ports to access the LAN for the supplicant systems. These ports can be divided into two kinds of logical ports: controlled ports and uncontrolled ports.

- The uncontrolled port is always in bi-directionally connected status, and mainly used to transmit EAPOL protocol frames, to guarantee that the supplicant systems can always send or receive authentication messages.
- The controlled port is in connected status authenticated to transmit service messages. When unauthenticated, no message from supplicant systems is allowed to be received.
- The controlled and uncontrolled ports are two parts of one port, which means each frame reaching this port is visible on both the controlled and uncontrolled ports.

### 3. Controlled direction

In unauthenticated status, controlled ports can be set as unidirectional controlled or bi-directionally controlled.

- When the port is bi-directionally controlled, the sending and receiving of all frames is forbidden.
- When the port is unidirectional controlled, no frames can be received from the supplicant systems while sending frames to the supplicant systems is allowed.

**Notes:** At present, this kind of switch only supports unidirectional control.

## 52.1.2 The Work Mechanism of 802.1x

IEEE 802.1x authentication system uses EAP (Extensible Authentication Protocol) to implement exchange of authentication information between the supplicant system, authenticator system and authentication server system.

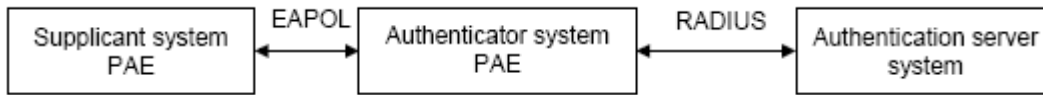

Figure 52-2 the Work Mechanism of 802.1x

- EAP messages adopt EAPOL encapsulation format between the PAE of the supplicant system and the PAE of the authenticator system in the environment of LAN.
- Between the PAE of the authenticator system and the RADIUS server, there are two methods to exchange information: one method is that EAP messages adopt EAPOR (EAP over RADIUS) encapsulation format in RADIUS protocol; the other is that EAP messages terminate with the PAE of the authenticator system, and adopt the messages containing PAP (Password Authentication Protocol) or CHAP (Challenge Handshake Authentication Protocol) attributes to do the authentication interaction with the RADIUS server.
- When the user pass the authentication, the authentication server system will send the relative information of the user to authenticator system, the PAE of the authenticator system will decide the authenticated/unauthenticated status of the controlled port according to the authentication result of the RADIUS server.

## 52.1.3 The Encapsulation of EAPOL Messages

### 1. The Format of EAPOL Data Packets

EAPOL is a kind of message encapsulation format defined in 802.1x protocol, and is mainly used to transmit EAP messages between the supplicant system and the authenticator system in order to allow the transmission of EAP messages through the LAN. In IEEE 802/Ethernet LAN environment, the format of EAPOL packet is illustrated in the next figure. The beginning of the EAPOL packet is the Type/Length domain in MAC frames.

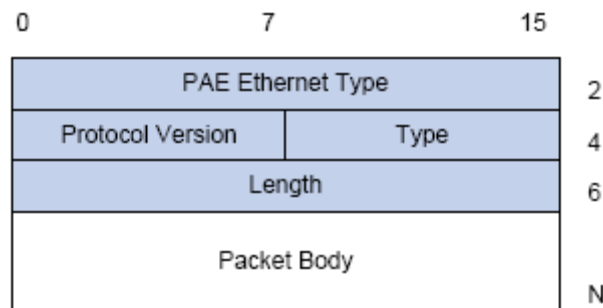

Figure 52-3 the Format of EAPOL Data Packet

PAE Ethernet Type: Represents the type of the protocol whose value is 0x888E.

Protocol Version: Represents the version of the protocol supported by the sender of EAPOL data packets.

Type: represents the type of the EAPOL data packets, including:

- EAP-Packet (whose value is 0x00): the authentication information frame, used to carry EAP messages. This kind of frame can pass through the authenticator system to transmit EAP messages between the supplicant system and the authentication server system.
- EAPOL-Start (whose value is 0x01): the frame to start authentication.
- EAPOL-Logoff (whose value is 0x02): the frame requesting to quit.
- EAPOL-Key (whose value is 0x03): the key information frame.
- EAPOL-Encapsulated-ASF-Alert (whose value is 0x04): used to support the Alerting messages of ASF (Alert Standard Forum). This kind of frame is used to encapsulate the relative information of network management such as all kinds of alerting information, terminated by terminal devices.

Length: represents the length of the data, that is, the length of the "Packet Body", in byte. There will be no following data domain when its value is 0.

Packet Body: represents the content of the data, which will be in different formats according to different types.

## 2. The Format of EAP Data Packets

When the value of Type domain in EAPOL packet is EAP-Packet, the Packet Body is in EAP format (illustrated in the next figure).

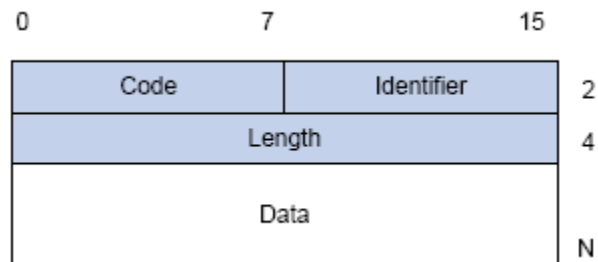

Figure 52-4 the Format of EAP Data Packets

Code: specifies the type of the EAP packet. There are four of them in total: Request (1), Response (2), Success (3), Failure (4).

- There is no Data domain in the packets of which the type is Success or Failure, and the value of the Length domains in such packets is 4.
- The format of Data domains in the packets of which the type is Request and Response is illustrated in the next figure. Type is the authentication type of EAP, the content of Type data depends on the type. For example, when the value of the type is 1, it means Identity, and is used to query the identity of the other side. When the type is 4, it means MD5-Challenge, like PPP CHAP protocol, contains query messages.

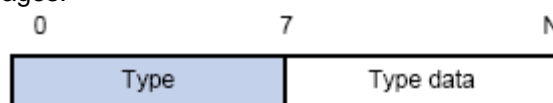

Figure 52-5 the Format of Data Domain in Request and Response Packets

Identifier: to assist matching the Request and Response messages.

Length: the length of the EAP packet, covering the domains of Code, Identifier, Length and Data, in byte.

Data: the content of the EAP packet, depending on the Code type.

### 52.1.4 The Encapsulation of EAP Attributes

RADIUS adds two attribute to support EAP authentication: EAP-Message and Message-Authenticator. Please refer to the Introduction of RADIUS protocol in “AAA-RADIUS-HWTACACS operation” to check the format of RADIUS messages.

#### 1. EAP-Message

As illustrated in the next figure, this attribute is used to encapsulate EAP packet, the type code is 79, String domain should be no longer than 253 bytes. If the data length in an EAP packet is larger than 253 bytes, the packet can be divided into fragments, which then will be encapsulated in several EAP-Messages attributes in their original order.

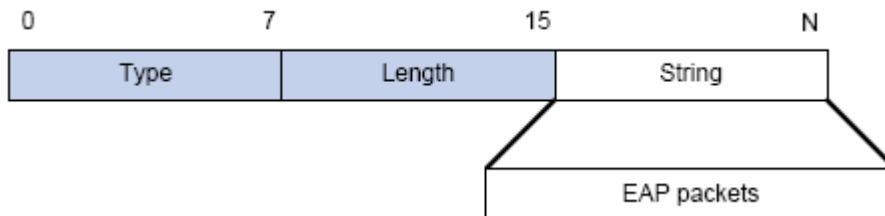

Figure 52-6 the Encapsulation of EAP-Message Attribute

#### 2. Message-Authenticator

As illustrated in the next figure, this attribute is used in the process of using authentication methods like EAP and CHAP to prevent the access request packets from being eavesdropped. Message-Authenticator should be included in the packets containing the EAP-Message attribute, or the packet will be dropped as an invalid one.

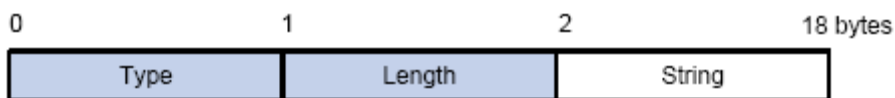

Figure 52-7 Message-Authenticator Attribute

### 52.1.5 Web Authentication Proxy based on 802.1x

The authentication can either be started by supplicant system initiatively or by devices. When the device detects unauthenticated users to access the network, it will send supplicant system EAP-Request/Identity messages to start authentication. On the other hand, the supplicant system can send EAPOL-Start message to the device via supplicant software.

802.1 x systems supports EAP relay method and EAP termination method to implement authentication with

the remote RADIUS server. The following is the description of the process of these two authentication methods, both started by the supplicant system.

### 52.1.5.1 EAP Relay Mode

EAP relay is specified in IEEE 802.1x standard to carry EAP in other high-level protocols, such as EAP over RADIUS, making sure that extended authentication protocol messages can reach the authentication server through complicated networks. In general, EAP relay requires the RADIUS server to support EAP attributes: EAP-Message and Message-Authenticator.

EAP is a widely-used authentication frame to transmit the actual authentication protocol rather than a special authentication mechanism. EAP provides some common function and allows the authentication mechanisms expected in the negotiation, which are called EAP Method. The advantage of EAP lies in that EAP mechanism working as a base needs no adjustment when a new authentication protocol appears. The following figure illustrates the protocol stack of EAP authentication method.

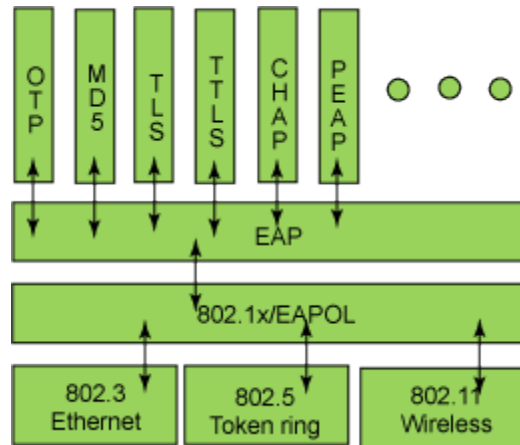

**Figure 52-8** the Protocol Stack of EAP Authentication Method

By now, there are more than 50 EAP authentication methods has been developed, the differences among which are those in the authentication mechanism and the management of keys. The 4 most common EAP authentication methods are listed as follows:

- **EAP-MD5**
- **EAP-TLS** (Transport Layer Security)
- **EAP-TTLS** (Tunneled Transport Layer Security)
- **PEAP** (Protected Extensible Authentication Protocol)

They will be described in detail in the following part.

**Attention:**

- The switch, as the access controlling unit of Pass-through, will not check the content of a particular EAP method, so can support all the EAP methods above and all the EAP authentication methods that may be extended in the future.
- In EAP relay, if any authentication method in EAP-MD5, EAP-TLS, EAP-TTLS and PEAP is adopted, the authentication methods of the supplicant system and the RADIUS server should be the same.



## 1. EAP-MD5 Authentication Method

EAP-MD5 is an IETF open standard which providing the least security, since MD5 Hash function is vulnerable to dictionary attacks.

The following figure illustrated the basic operation flow of the EAP-MD5 authentication method.

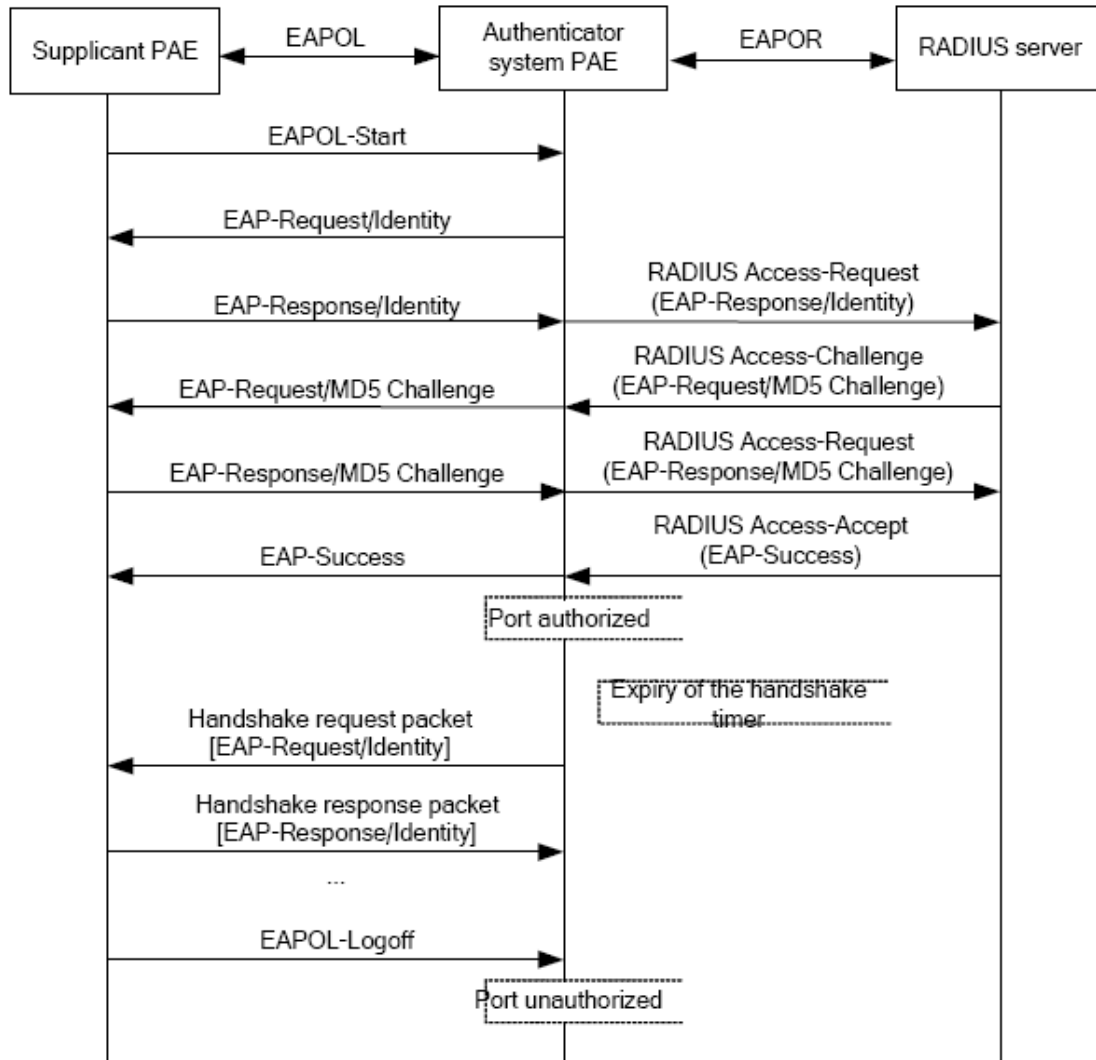
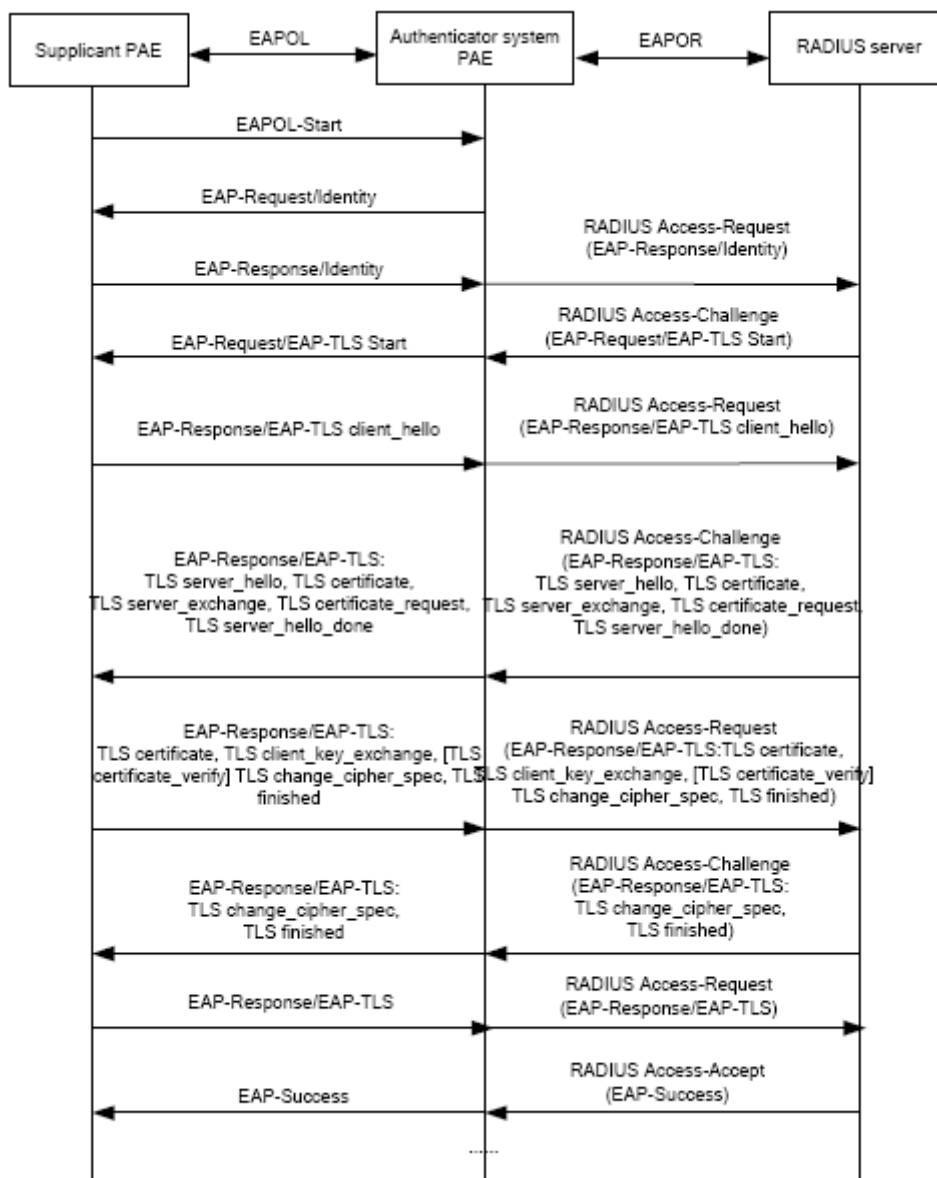

Figure 52-9 the Authentication Flow of 802.1x EAP-MD5

## 2. EAP-TLS Authentication Method

EAP-TLS is brought up by Microsoft based on EAP and TLS protocols. It uses PKI to protect the id authentication between the supplicant system and the RADIUS server and the dynamically generated session keys, requiring both the supplicant system and the Radius authentication server to possess digital certificate to implement bidirectional authentication. It is the earliest EAP authentication method used in wireless LAN. Since every user should have a digital certificate, this method is rarely used practically considering the difficult maintenance. However it is still one of the safest EAP standards, and enjoys prevailing supports from the vendors of wireless LAN hardware and software.

The following figure illustrates the basic operation flow of the EAP-TLS authentication method.



**Figure 52-10** the Authentication Flow of 802.1x EAP-TLS

### 3. EAP-TTLS Authentication Method

EAP-TTLS is a product of the cooperation of Funk Software and Certicom. It can provide an authentication as strong as that provided by EAP-TLS, but without requiring users to have their own digital certificate. The only request is that the Radius server should have a digital certificate. The authentication of users' identity is implemented with passwords transmitted in a safely encrypted tunnel established via the certificate of the authentication server. Any kind of authentication request including EAP, PAP and MS-CHAPV2 can be transmitted within TTLS tunnels.

### 4. PEAP Authentication Method

EAP-PEAP is brought up by Cisco, Microsoft and RAS Security as a recommended open standard. It has long been utilized in products and provides very good security. Its design of protocol and security is similar to that of EAP-TTLS, using a server's PKI certificate to establish a safe TLS tunnel in order to protect user authentication.

The following figure illustrates the basic operation flow of PEAP authentication method.

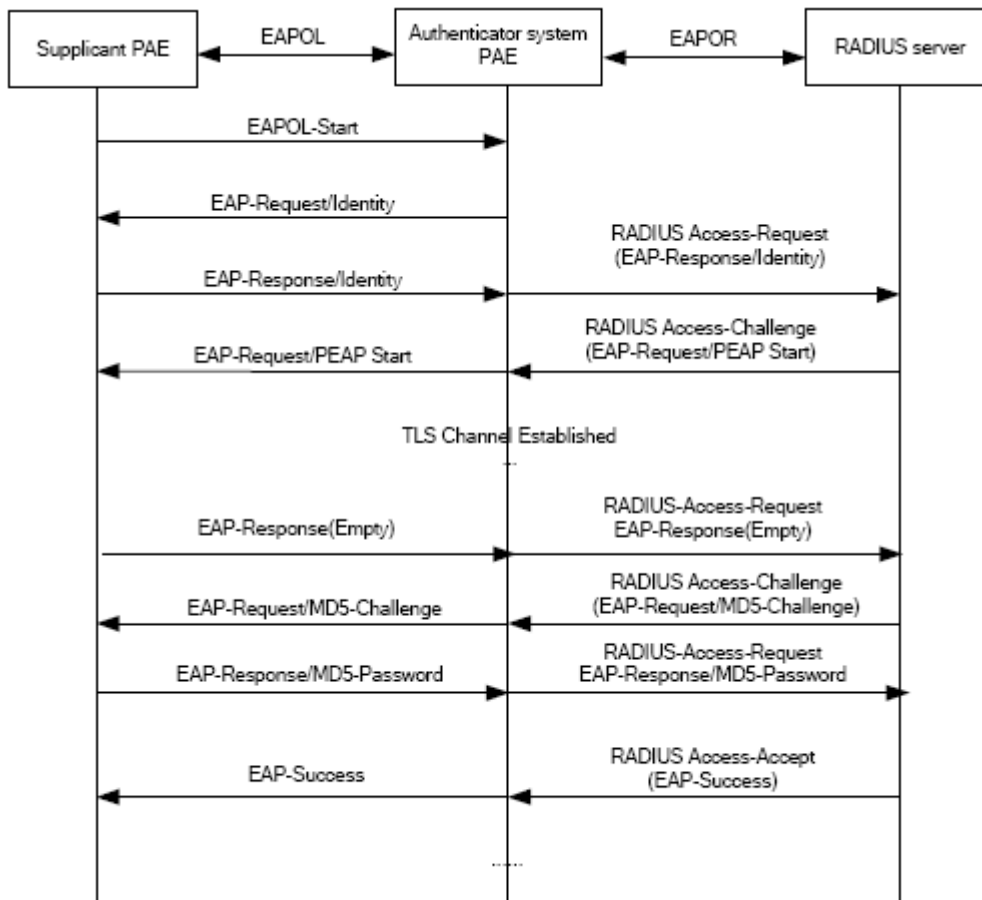

Figure 52-11 the Authentication Flow of 802.1x PEAP

### 52.1.5.2 EAP Termination Mode

In this mode, EAP messages will be terminated in the access control unit and mapped into RADIUS messages, which is used to implement the authentication, authorization and fee-counting. The basic operation flow is illustrated in the next figure.

In EAP termination mode, the access control unit and the RADIUS server can use PAP or CHAP authentication method. The following figure will demonstrate the basic operation flow using CHAP authentication method.

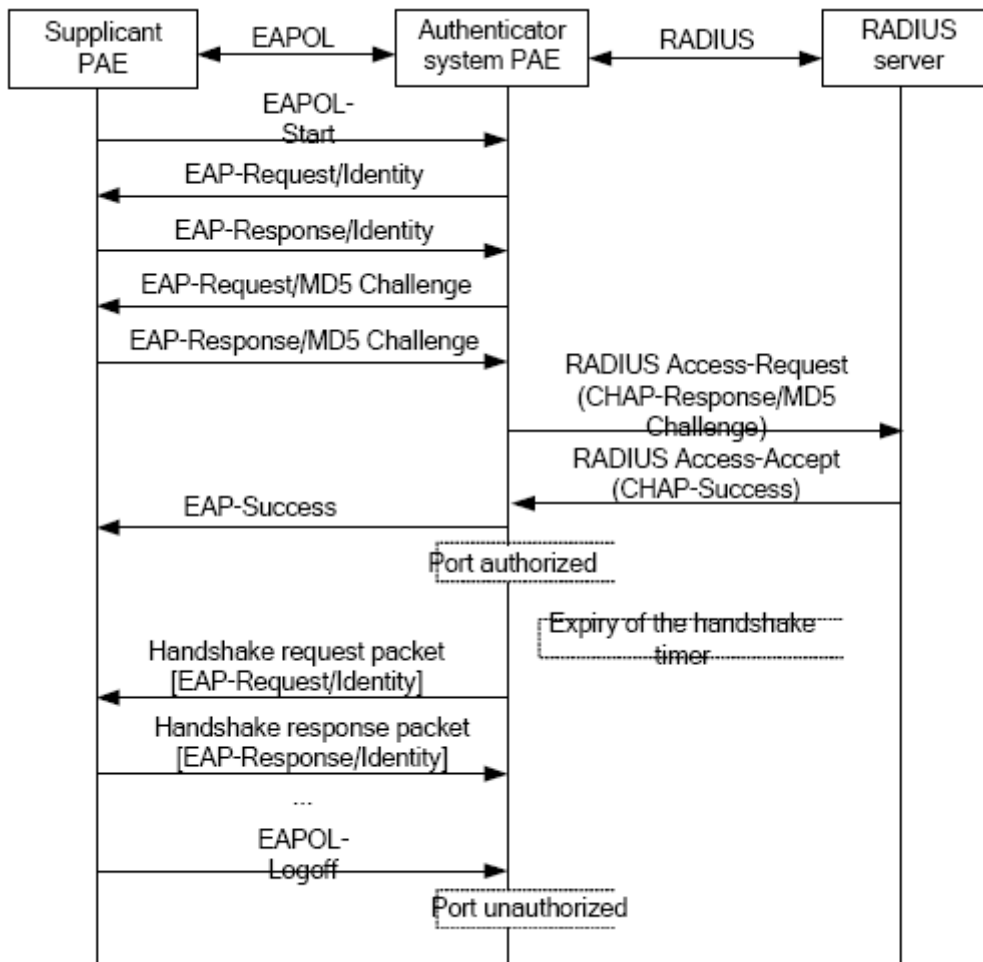

Figure 52-12 the Authentication Flow of 802.1x EAP Termination Mode

### 52.1.6 The Extension and Optimization of 802.1x

Besides supporting the port-based access authentication method specified by the protocol, devices also extend and optimize it when implementing the EAP relay mode and EAP termination mode of 802.1x.

- ◆ Supports some applications in the case of which one physical port can have more than one users
- ◆ There are three access control methods (the methods to authenticate users): port-based, MAC-based and user-based (IP address+ MAC address+ port).
  - When the port-based method is used, as long as the first user of this port passes the authentication, all the other users can access the network resources without being authenticated. However, once the first user is offline, the network won't be available to all the other users.
  - When the MAC-based method is used, all the users accessing a port should be authenticated separately, only those pass the authentication can access the network, while the others can not. When one user becomes offline, the other users will not be affected.
  - When the user-based (IP address+ MAC address+ port) method is used, all users can access limited resources before being authenticated. There are two kinds of control in this method: standard control and advanced control. The user-based standard control will not restrict the access to limited

---

resources, which means all users of this port can access limited resources before being authenticated. The user-based advanced control will restrict the access to limited resources, only some particular users of the port can access limited resources before being authenticated. Once those users pass the authentication, they can access all resources.

Attention: when using private supplicant systems, user-based advanced control is recommended to effectively prevent ARP cheat.

The maximum number of the authenticated users can be 4000, but less than 2000 will be preferred.

## 52.1.7 The Features of VLAN Allocation

### 1. Auto VLAN

Auto VLAN feature enables RADIUS server to change the VLAN to which the access port belongs, based on the user information and the user access device information. When an 802.1x user passes authentication on the server, the RADIUS server will send the authorization information to the device, if the RADIUS server has enabled the VLAN-assigning function, then the following attributes should be included in the Access-Accept messages:

- Tunnel-Type = VLAN (13)
- Tunnel-Medium-Type = 802 (6)
- Tunnel-Private-Group-ID = VLANID

The VLANID here means the VID of VLAN, ranging from 1 to 4094. For example, Tunnel-Private-Group-ID = 30 means VLAN 30.

When the switch receives the assigned Auto VLAN information, the current Access port will leave the VLAN set by the user and join Auto VLAN.

Auto VLAN won't change or affect the port's configuration. But the priority of Auto VLAN is higher than that of the user-set VLAN, that is Auto VLAN is the one takes effect when the authentication is finished, while the user-set VLAN do not work until the user become offline.

Notes: At present, Auto VLAN can only be used in the port-based access control mode, and on the ports whose link type is Access.

### 2. Guest VLAN

Guest VLAN feature is used to allow the unauthenticated user to access some specified resources.

The user authentication port belongs to a default VLAN (Guest VLAN) before passing the 802.1x authentication, with the right to access the resources within this VLAN without authentication. But the resources in other networks are beyond reach. Once authenticated, the port will leave Guest VLAN, and the user can access the resources of other networks.

In Guest VLAN, users can get 802.1x supplicant system software, update supplicant system or update some other applications (such as anti-virus software, the patches of operating system). The access device will add

the port into Guest VLAN if there is no supplicant getting authenticated successfully in a certain stretch of time because of lacking exclusive authentication supplicant system or the version of the supplicant system being too low.

Once the 802.1x feature is enabled and the Guest VLAN is configured properly, a port will be added into Guest VLAN, just like Auto VLAN, if there is no response message from the supplicant system after the device sends more authentication-triggering messages than the upper limit (EAP-Request/Identity) from the port.

- The authentication server assigns an Auto VLAN, and then the port leaves Guest VLAN and joins the assigned Auto VLAN. When the user becomes offline, the port will be allocated to the specified Guest VLAN again.
- The authentication server assigns an Auto VLAN, and then the port leaves Guest VLAN and joins the specified VLAN. When the user becomes offline, the port will be allocated to the specified Guest VLAN again.

## 52.2 802.1x Configuration Task List

802.1x Configuration Task List:

1. Enable IEEE 802.1x function
2. Access management unit property configuration
  - 1) Configure port authentication status
  - 2) Configure access management method for the port: MAC-based or port-based
  - 3) Configure expanded 802.1x function
3. User access devices related property configuration (optional)

### 1. Enable 802.1x function

Command	Explanation
Global Mode	
<b>dot1x enable</b> <b>no dot1x enable</b>	Enables the 802.1x function in the switch and ports; the no command disables the 802.1x function.
<b>dot1x privateclient enable</b> <b>no dot1x privateclient enable</b>	Enables the switch force client software using private 802.1x authentication packet format. The no command will disable this function.
<b>dot1x user free-resource</b> <b>&lt;prefix&gt; &lt;mask&gt;</b> <b>no dot1x user free-resource</b>	Sets free access network resource for unauthorized dot1x user. The no command close the resource.
<b>dot1x unicast enable</b> <b>no dot1x unicast enable</b>	Enable the 802.1x unicast passthrough function of switch; the no operation of this command will disable this function.

### 2. Access management unit property configuration

- 1) Configure port authentication status

Command	Explanation
Port Mode	
<b>dot1x port-control</b> <b>{auto force-authorized force-unauthorized }</b> <b>no dot1x port-control</b>	Sets the 802.1x authentication mode; the no command restores the default setting.

2) Configure port access management method

Command	Explanation
Port Mode	
<b>dot1x port-method</b> <b>{macbased   portbased</b> <b> webbased userbased</b> <b>advanced}</b> <b>no dot1x port-method</b>	Sets the port access management method; the no command restores MAC-based access management.
<b>dot1x max-user macbased</b> <b>&lt;number&gt;</b> <b>no dot1x max-user</b> <b>macbased</b>	Sets the maximum number of access users for the specified port; the no command restores the default setting of allowing 1 user.
<b>dot1x max-user userbased</b> <b>&lt;number&gt;</b> <b>no dot1x max-user</b> <b>userbased</b>	Set the upper limit of the number of users allowed accessing the specified port, only used when the access control mode of the port is userbased; the no command is used to reset the limit to 10 by default.
<b>dot1x guest-vlan &lt;vlanID&gt;</b> <b>no dot1x guest-vlan</b>	Set the guest vlan of the specified port; the no command is used to delete the guest vlan.

3) Configure expanded 802.1x function

Command	Explanation
Global Mode	
<b>dot1x macfilter enable</b> <b>no dot1x macfilter enable</b>	Enables the 802.1x address filter function in the switch; the no command disables the 802.1x address filter function.
<b>dot1x accept-mac</b> <b>&lt;mac-address&gt; [interface</b> <b>&lt;interface-name&gt; ]</b> <b>no dot1x accept-mac</b> <b>&lt;mac-address&gt; [interface</b> <b>&lt;interface-name&gt; ]</b>	Adds 802.1x address filter table entry, the no command deletes 802.1x filter address table entries.

<b>dot1x eapor enable</b> <b>no dot1x eapor enable</b>	Enables the EAP relay authentication function in the switch; the no command sets EAP local end authentication.
---	--

### 3. Supplicant related property configuration

Command	Explanation
Global Mode	
<b>dot1x max-req &lt;count&gt;</b> <b>no dot1x max-req</b>	Sets the number of EAP request/MD5 frame to be sent before the switch re-initials authentication on no supplicant response, the no command restores the default setting.
<b>dot1x re-authentication</b> <b>no dot1x re-authentication</b>	Enables periodical supplicant authentication; the no command disables this function.
<b>dot1x timeout quiet-period</b> <b>&lt;seconds&gt;</b> <b>no dot1x timeout</b> <b>quiet-period</b>	Sets time to keep silent on port authentication failure; the no command restores the default value.
<b>dot1x timeout re-authperiod</b> <b>&lt;seconds&gt;</b> <b>no dot1x timeout</b> <b>re-authperiod</b>	Sets the supplicant re-authentication interval; the no command restores the default setting.
<b>dot1x timeout tx-period</b> <b>&lt;seconds&gt;</b> <b>no dot1x timeout tx-period</b>	Sets the interval for the supplicant to re-transmit EAP request/identity frame; the no command restores the default setting.
<b>dot1x re-authenticate</b> <b>[interface &lt;interface-name&gt; ]</b>	Enables IEEE 802.1x re-authentication (no wait timeout requires) for all ports or a specified port.



## 52.3 802.1x Application Example

### 52.3.1 Examples of Guest Vlan Applications

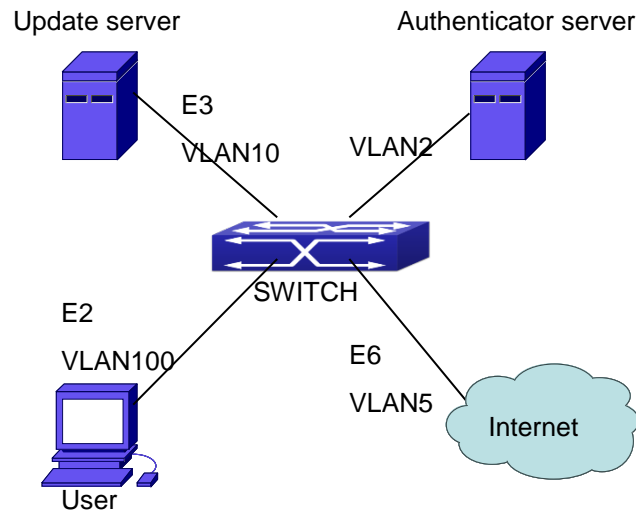

Figure 52-13 The Network Topology of Guest VLAN

Notes: in the figures in this session, E2 means Ethernet 1/0/2, E3 means Ethernet 1/0/3 and E6 means Ethernet 1/0/6.

As showed in the next figure, a switch accesses the network using 802.1x authentication, with a RADIUS server as its authentication server. Ethernet1/0/2, the port through which the user accesses the switch belongs to VLAN100; the authentication server is in VLAN2; Update Server, being in VLAN10, is for the user to download and update supplicant system software; Ethernet1/6, the port used by the switch to access the Internet is in VLAN5.

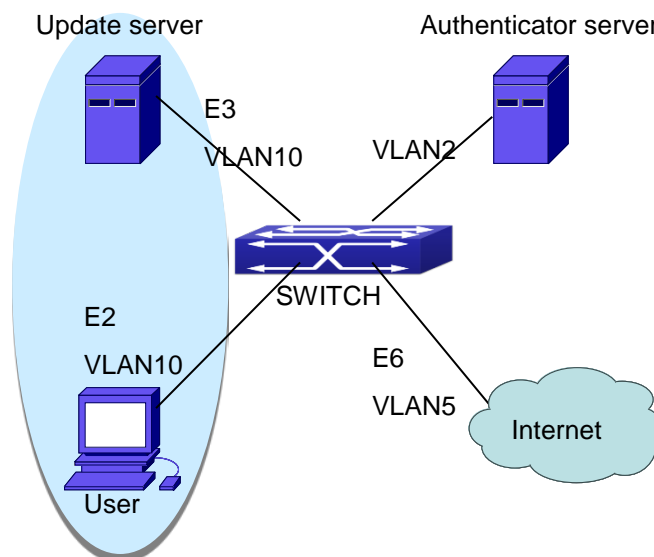
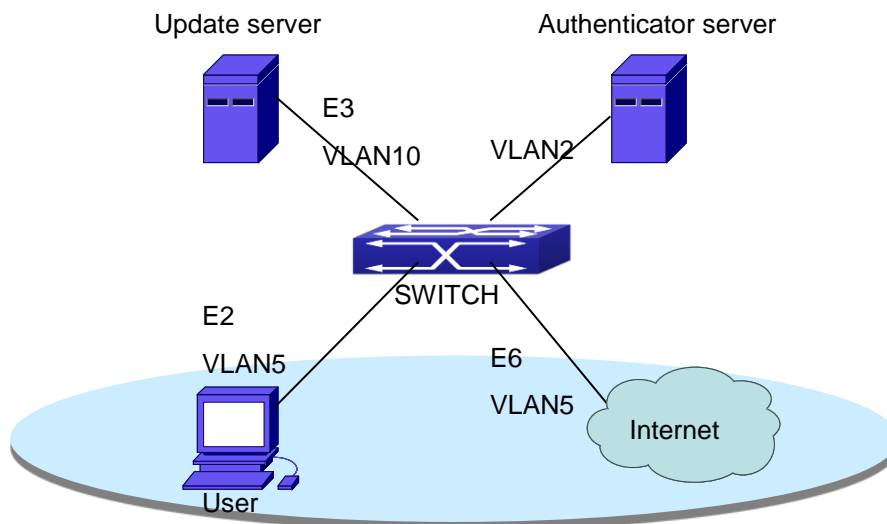

Figure 52-14 User Joining Guest VLAN

As illustrated in the up figure, on the switch port Ethernet1/0/2, the 802.1x feature is enabled, and the VLAN10 is set as the port's Guest VLAN. Before the user gets authenticated or when the user fails to do so, port Ethernet1/0/2 is added into VLAN10, allowing the user to access the Update Server.



**Figure 52-15** User Being Online, VLAN Being Offline

As illustrated in the up figure, when the users become online after a successful authentication, the authentication server will assign VLAN5, which makes the user and Ethernet1/6 both in VLAN5, allowing the user to access the Internet.

The following are configuration steps:

```
# Configure RADIUS server.
Switch(config)#radius-server authentication host 10.1.1.3
Switch(config)#radius-server accounting host 10.1.1.3
Switch(config)#radius-server key test
Switch(config)#aaa enable
Switch(config)#aaa-accounting enable

# Create VLAN100.
Switch(config)#vlan 100

# Enable the global 802.1x function
Switch(config)#dot1x enable

# Enable the 802.1x function on port Ethernet1/0/2
Switch(config)#interface ethernet1/0/2
Switch(Config-If-Ethernet1/0/2)#dot1x enable
```

```
# Set the link type of the port as access mode.
Switch(Config-If-Ethernet1/0/2)#switch-port mode access

# Set the access control mode on the port as portbased.
Switch(Config-If-Ethernet1/0/2)#dot1x port-method portbased

# Set the access control mode on the port as auto.
Switch(Config-If-Ethernet1/0/2)#dot1x port-control auto

# Set the port's Guest VLAN as 100.
Switch(Config-If-Ethernet1/0/2)#dot1x guest-vlan 100
Switch(Config-If-Ethernet1/0/2)#exit
```

Using the command of **show running-config** or **show interface ethernet 1/2**, users can check the configuration of Guest VLAN. When there is no online user, no failed user authentication or no user gets offline successfully, and more authentication-triggering messages (EAP-Request/Identity) are sent than the upper limit defined, users can check whether the Guest VLAN configured on the port takes effect with the command **show vlan id 100**.

### 52.3.2 Examples of IPv4 Radius Applications

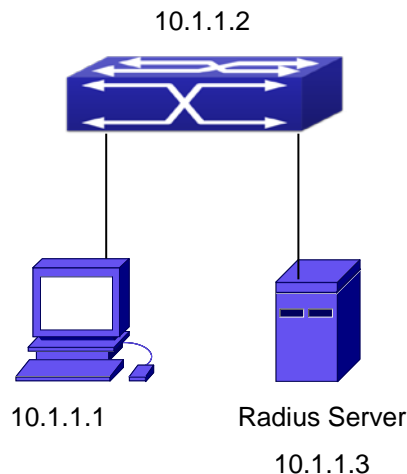

**Figure 52-16** IEEE 802.1x Configuration Example Topology

The PC is connecting to port 1/0/2 of the switch; IEEE 802.1x authentication is enabled on port1/0/2; the access mode is the default MAC-based authentication. The switch IP address is 10.1.1.2. Any port other than port 1/0/2 is used to connect to RADIUS authentication server, which has an IP address of 10.1.1.3, and use the default port 1812 for authentication and port 1813 for accounting. IEEE 802.1x authentication client

software is installed on the PC and is used in IEEE 802.1x authentication.

```
Switch(config)#interface vlan 1
Switch(Config-if-vlan1)#ip address 10.1.1.2 255.255.255.0
Switch(Config-if-vlan1)#exit
Switch(config)#radius-server authentication host 10.1.1.3
Switch(config)#radius-server accounting host 10.1.1.3
Switch(config)#radius-server key test
Switch(config)#aaa enable
Switch(config)#aaa-accounting enable
Switch(config)#dot1x enable
Switch(config)#interface ethernet 1/0/2
Switch(Config-If-Ethernet1/0/2)#dot1x enable
Switch(Config-If-Ethernet1/0/2)#dot1x port-control auto
Switch(Config-If-Ethernet1/0/2)#exit
```

### 52.3.3 Examples of IPv6 Radius Application

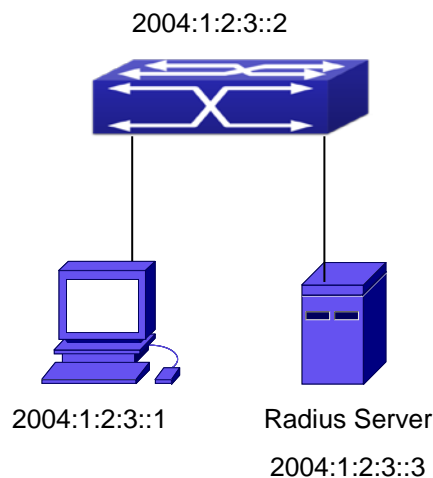

**Figure 52-17 IPv6 Radius**

Connect the computer to the interface 1/0/2 of the switch, and enable IEEE802.1x on interface1/0/2. Use MAC based authentication. Configure the IP address of the switch as 2004:1:2:3::2, and connect the switch with any interface except interface 1/0/2 to the RADIUS authentication server. Configure the IP address of the RADIUS server to be 2004:1:2:3::3. Use the default ports 1812 and 1813 for authentication and accounting respectively. Install the IEEE802.1x authentication client software on the computer, and use the client for IEEE802.1x authentication.

---

The detailed configurations are listed as below:

```
Switch(config)#interface vlan 1
Switch(Config-if-vlan1)#ipv6 address 2004:1:2:3::2/64
Switch(Config-if-vlan1)#exit
Switch(config)#radius-server authentication host 2004:1:2:3::3
Switch(config)#radius-server accounting host 2004:1:2:3::3
Switch(config)#radius-server key test
Switch(config)#aaa enable
Switch(config)#aaa-accounting enable
Switch(config)#dot1x enable
Switch(config)#interface ethernet 1/0/2
Switch(Config-If-Ethernet1/0/2)#dot1x enable
Switch(Config-If-Ethernet1/0/2)#dot1x port-control auto
Switch(Config-If-Ethernet1/0/2)#exit
```

## 52.4 802.1x Troubleshooting

It is possible that 802.1x be configured on ports and 802.1x authentication be set to auto, t switch can't be to authenticated state after the user runs 802.1x supplicant software. Here are some possible causes and solutions:

- If 802.1x cannot be enabled for a port, make sure the port is not executing MAC binding, or configured as a port aggregation. To enable the 802.1x authentication, the above functions must be disabled.
- If the switch is configured properly but still cannot pass through authentication, connectivity between the switch and RADIUS server, the switch and 802.1x client should be verified, and the port and VLAN configuration for the switch should be checked, too.
- Check the event log in the RADIUS server for possible causes. In the event log, not only unsuccessful logins are recorded, but prompts for the causes of unsuccessful login. If the event log indicates wrong authenticator password, radius-server key parameter shall be modified; if the event log indicates no such authenticator, the authenticator needs to be added to the RADIUS server; if the event log indicates no such login user, the user login ID and password may be wrong and should be verified and input again.

---

# Chapter 53 The Number Limitation Function of Port, MAC in VLAN and IP Configuration

## 53.1 Introduction to the Number Limitation Function of Port, MAC in VLAN and IP

MAC address list is used to identify the mapping relationship between the destination MAC addresses and the ports of switch. There are two kinds of MAC addresses in the list: static MAC address and dynamic MAC address. The static MAC address is set by users, having the highest priority (will not be overwritten by dynamic MAC address), and will always be effective; dynamic MAC address is learnt by the switch through transmitting data frames, and will only be effective in a specific time range. When the switch receives a data framed waiting to be transmitted, it will study the source MAC address of the data frame, build a mapping relationship with the receiving port, and then look up the MAC address list for the destination MAC address. If any matching list entry is found, the switch will transmit the data frame via the corresponding port, or, the switch will broadcast the data frame over the VLAN it belongs to. If the dynamically learnt MAC address matches no transmitted data in a long time, the switch will delete it from the MAC address list.

Usually the switch supports both the static configuration and dynamic study of MAC address, which means each port can have more than one static set MAC addresses and dynamically learnt MAC addresses, and thus can implement the transmission of data traffic between port and known MAC addresses. When a MAC address becomes out of date, it will be dealt with broadcast. No number limitation is put on MAC address of the ports of our current switches; every port can have several MAC addressed either by configuration or study, until the hardware list entries are exhausted. To avoid too many MAC addresses of a port, we should limit the number of MAC addresses a port can have.

For each INTERFACE VLAN, there is no number limitation of IP; the upper limit of the number of IP is the upper limit of the number of user on an interface, which is, at the same time, the upper limit of ARP and ND list entry. There is no relative configuration command can be used to control the sent number of these list entries. To enhance the security and the controllability of our products, we need to control the number of MAC address on each port and the number of ARP, ND on each INTERFACE VLAN. The number of static or dynamic MAC address on a port should not exceed the configuration. The number of user on each VLAN should not exceed the configuration, either.

Limiting the number of MAC and ARP list entry can avoid DOS attack to a certain extent. When malicious users frequently do MAC or ARP cheating, it will be easy for them to fill the MAC and ARP list entries of the switch, causing successful DOS attacks.

To summer up, it is very meaningful to develop the number limitation function of port, MAC in VLAN and IP. Switch can control the number of MAC address of ports and the number ARP, ND list entry of ports and VLAN

---

through configuration commands.

Limiting the number of dynamic MAC and IP of ports:

1. Limiting the number of dynamic MAC. If the number of dynamically learnt MAC address by the switch is already larger than or equal with the max number of dynamic MAC address, then shutdown the MAC study function on this port, otherwise, the port can continue its study.
2. Limiting the number of dynamic IP. If the number of dynamically learnt ARP and ND by the switch is already larger than or equal with the max number of dynamic ARP and ND, then shutdown the ARP and ND study function of this port, otherwise, the port can continue its study.

Limiting the number of MAC, ARP and ND of interfaces:

1. Limiting the number of dynamic MAC. If the number of dynamically learnt MAC address by the VLAN of the switch is already larger than or equal with the max number of dynamic MAC address, then shutdown the MAC study function of all the ports in this VLAN, otherwise, all the ports in this VLAN can continue their study (except special ports).
2. Limiting the number of dynamic IP. If the number of dynamically learnt ARP and ND by the switch is already larger than or equal with the max number of dynamic ARP and ND, then the VLAN will not study any new ARP or ND, otherwise, the study can be continued.

## 53.2 The Number Limitation Function of Port, MAC in VLAN and IP Configuration Task Sequence

1. Enable the number limitation function of MAC and IP on ports
2. Enable the number limitation function of MAC and IP in VLAN
3. Configure the timeout value of querying dynamic MAC
4. Configure the violation mode of ports
5. Display and debug the relative information of number limitation of MAC and IP on ports

### 1 · Enable the number limitation function of MAC 、IP on ports

Command	Explanation
Port configuration mode	
<b>switchport mac-address dynamic maximum &lt;value&gt;</b> <b>no switchport mac-address dynamic maximum</b>	Enable and disable the number limitation function of MAC on the ports.
<b>switchport arp dynamic maximum &lt;value&gt;</b> <b>no switchport arp dynamic maximum</b>	Enable and disable the number limitation function of ARP on the ports.
<b>switchport nd dynamic maximum &lt;value&gt;</b> <b>no switchport nd dynamic maximum</b>	Enable and disable the number limitation function of ND on the ports.

## 2 · Enable the number limitation function of MAC · IP in VLAN

Command	Explanation
VLAN configuration mode	
<b>vlan mac-address dynamic maximum &lt;value&gt;</b> <b>no vlan mac-address dynamic maximum</b>	Enable and disable the number limitation function of MAC in the VLAN.
Interface configuration mode	
<b>ip arp dynamic maximum &lt;value&gt;</b> <b>no ip arp dynamic maximum</b>	Enable and disable the number limitation function of ARP in the VLAN.
<b>ipv6 nd dynamic maximum &lt;value&gt;</b> <b>no ipv6 nd dynamic maximum</b>	Enable and disable the number limitation function of NEIGHBOR in the VLAN.

## 3 · Configure the timeout value of querying dynamic MAC.

Command	Explanation
Global configuration mode	
<b>mac-address query timeout &lt;seconds&gt;</b>	Configure the timeout value of querying dynamic MAC.

## 4 · Configure the violation mode of ports

Command	Explanation
Port mode	
<b>switchport mac-address violation {protect / shutdown} [recovery &lt;5-3600&gt;]</b> <b>no switchport mac-address violation</b>	Set the violation mode of the port, the no command restores the violation mode to <b>protect</b> .

## 5 · Display and debug the relative information of number limitation of MAC and IP on ports

Command	Explanation
Admin mode	
<b>show mac-address dynamic count {vlan &lt;vlan-id&gt;   interface ethernet &lt;portName&gt; }</b>	Display the number of dynamic MAC in corresponding ports and VLAN.
<b>show arp-dynamic count {vlan &lt;vlan-id&gt;   interface ethernet &lt;portName&gt; }</b>	Display the number of dynamic ARP in corresponding ports and VLAN.



<code>show nd-dynamic count {vlan &lt;vlan-id&gt;   interface ethernet &lt;portName&gt; }</code>	Display the number of dynamic NEIGHBOUR in corresponding ports and VLAN.
<code>debug switchport mac count</code> <code>no debug switchport mac count</code>	All kinds of debug information when limiting the number of MAC on ports.
<code>debug switchport arp count</code> <code>no debug switchport arp count</code>	All kinds of debug information when limiting the number of ARP on ports.
<code>debug switchport nd count</code> <code>no debug switchport nd count</code>	All kinds of debug information when limiting the number of NEIGHBOUR on ports.
<code>debug vlan mac count</code> <code>no debug vlan mac count</code>	All kinds of debug information when limiting the number of MAC in VLAN.
<code>debug ip arp count</code> <code>no debug ip arp count</code>	All kinds of debug information when limiting the number of ARP in VLAN.
<code>debug ipv6 nd count</code> <code>no debug ipv6 nd count</code>	All kinds of debug information when limiting the number of MAC in VLAN.

### 53.3 The Number Limitation Function of Port, MAC in VLAN and IP Typical Examples

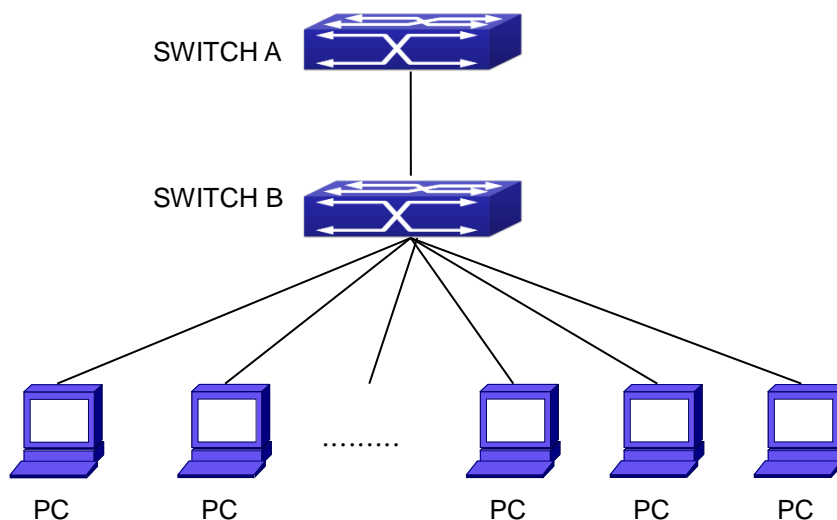

**Figure 53-1** The Number Limitation of Port, MAC in VLAN and IP Typical Configuration Example

In the network topology above, SWITCH B connects to many PC users, before enabling the number limitation function of MAC and IP in Port, VLAN, if the system hardware has no other limitation, SWITCH A and

---

SWITCH B can get the MAC, ARP, ND list entries of all the PC, so limiting the MAC, ARP list entry can avoid DOS attack to a certain extent. When malicious users frequently do MAC, ARP cheating, it will be easy for them to fill the MAC, ARP list entries of the switch, causing successful DOS attacks. Limiting the MAC, ARP, ND list entry can prevent DOS attack.

On port 1/0/1 of SWITCH A, set the max number can be learnt of dynamic MAC address as 20, dynamic ARP address as 20, NEIGHBOR list entry as 10. In VLAN 1, set the max number of dynamic MAC address as 30, of dynamic ARP address as 30, NEIGHBOR list entry as 20.

SWITCH A configuration task sequence:

```
Switch (config)#interface ethernet 1/0/1
Switch (Config-If-Ethernet1/0/1)#switchport mac-address dynamic maximum 20
Switch (Config-If-Ethernet1/0/1)#switchport arp dynamic maximum 20
Switch (Config-If-Ethernet1/0/1)#switchport nd dynamic maximum 10
Switch (Config-if-Vlan1)#vlan mac-address dynamic maximum 30
```

## 53.4 The Number Limitation Function of Port, MAC in VLAN and IP Troubleshooting Help

The number limitation function of MAC and IP in Port, VLAN is disabled by default, if users need to limit the number of user accessing the network, they can enable it. If the number limitation function of MAC address can not be configured, please check whether Spanning-tree, dot1x, TRUNK is running on the switch and whether the port is configured as a MAC-binding port. The number limitation function of MAC address is mutually exclusive to these configurations, so if the users need to enable the number limitation function of MAC address on the port, they should check these functions mentioned above on this port are disabled.

If all the configurations are normal, after enabling the number limitation function of MAC and IP in Port, VLAN, users can use debug commands to debug every limitation, check the details of number limitations and judge whether the number limitation function is correct. If there is any problem, please sent result to technical service center.

# Chapter 54 Operational Configuration of AM Function

## 54.1 Introduction to AM Function

AM (Access Management) means that when a switch receives an IP or ARP message, it will compare the information extracted from the message (such as source IP address or source MAC-IP address) with the configured hardware address pool. If there is an entry in the address pool matching the information (source IP address or source MAC-IP address), the message will be forwarded, otherwise, dumped. The reason why source-IP-based AM should be supplemented by source-MAC-IP-based AM is that IP address of a host might change. Only with a bound IP, can users change the IP of the host into forwarding IP, and hence enable the messages from the host to be forwarded by the switch. Given the fact that MAC-IP can be exclusively bound with a host, it is necessary to make MAC-IP bound with a host for the purpose of preventing users from maliciously modifying host IP to forward the messages from their hosts via the switch.

With the interface-bound attribute of AM, network managers can bind the IP (MAC-IP) address of a legal user to a specified interface. After that, only the messages sending by users with specified IP (MAC-IP) addresses can be forwarded via the interface, and thus strengthen the monitoring of the network security.

## 54.2 AM Function Configuration Task List

- 1 · Enable AM function
- 2 · Enable AM function on an interface
- 3 · Configure the forwarding IP
- 4 · Configure the forwarding MAC-IP
- 5 · Delete all of the configured IP or MAC-IP or both
- 6 · Display relative configuration information of AM

### 1. Enable AM function

Command	Explanation
Global Mode	
<b>am enable</b> <b>no am enable</b>	Globally enable or disable AM function.

### 2. Enable AM function on an interface

Command	Explanation
Port Mode	

<b>am port</b> <b>no am port</b>	Enable/disable AM function on the port. When the AM function is enabled on the port, no IP or ARP message will be forwarded by default.
-------------------------------------	---

### 3. Configure the forwarding IP

Command	Explanation
Port Mode	
<b>am ip-pool &lt;ip-address&gt; &lt;num&gt;</b> <b>no am ip-pool &lt;ip-address&gt; &lt;num&gt;</b>	Configure the forwarding IP of the port.

### 4. Configure the forwarding MAC-IP

Command	Explanation
Port Mode	
<b>am mac-ip-pool &lt;mac-address&gt;</b> <b>&lt;ip-address&gt;</b> <b>no am mac-ip-pool &lt;mac-address&gt;</b> <b>&lt;ip-address&gt;</b>	Configure the forwarding MAC-IP of the port.

### 5. Delete all of the configured IP or MAC-IP or both

Command	Explanation
Global Mode	
<b>no am all [ip-pool mac-ip-pool]</b>	Delete MAC-IP address pool or IP address pool or both pools configured by all users.

### 6. Display relative configuration information of AM

Command	Explanation
Global Configuration Mode	
<b>show am [interface &lt;interface-name&gt;]</b>	Display the AM configuration information of one port or all ports.

## 54.3 AM Function Example

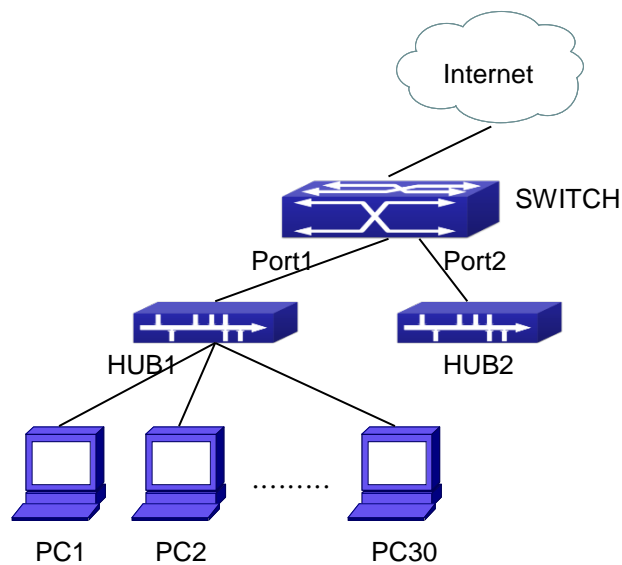

**Figure 54-1** a typical configuration example of AM function

In the topology above, 30 PCs, after converged by HUB1, connect with interface1 on the switch. The IP addresses of these 30 PCs range from 100.10.10.1 to 100.10.10.30. Considering security, the system manager will only take user with an IP address within that range as legal ones. And the switch will only forward data packets from legal users while dumping packets from other users.

According to the requirements mentioned above, the switch can be configured as follows:

```
Switch(config)#am enable
Switch(config)#interface ethernet1/0/1
Switch(Config-If-Ethernet1/0/1)#am port
Switch(Config-If-Ethernet1/0/1)#am ip-pool 10.10.10.1 10
```

## 54.4 AM Function Troubleshooting

AM function is disabled by default, and after it is enabled, relative configuration of AM can be made. Users can view the current AM configuration with “show am” command, such as whether the AM is enabled or not, and AM information on each interface, they can also use “show am [interface <interface-name>]” command to check the AM configuration information on a specific interface.

If any operational error happens, the system will display detailed corresponding prompt.

# Chapter 55 TACACS+ Configuration

## 55.1 Introduction to TACACS+

TACACS+ terminal access controller access control protocol is a protocol similar to the RADIUS protocol for controlling the terminal access to the network. Three independent functions of Authentication, Authorization, Accounting are also available in this protocol. Compared with RADIUS, the transmission layer of TACACS+ protocol is adopted with TCP protocol, further with the packet head (except for standard packet head) encryption, this protocol is of a more reliable transmission and encryption characteristics, and is more adapted to security control.

According to the characteristics of the TACACS+ (Version 1.78), we provide TACACS+ authentication function on the switch, when the user logs, such as telnet, the authentication of user name and password can be carried out with TACACS+.

## 55.2 TACACS+ Configuration Task List

1. Configure the TACACS+ authentication key
2. Configure the TACACS+ server
3. Configure the TACACS+ authentication timeout time
4. Configure the IP address of the RADIUS NAS

### 1. Configure the TACACS+ authentication key

Command	Explanation
Global Mode	
<b>tacacs-server key &lt;string&gt;</b> <b>no tacacs-server key</b>	Configure the TACACS+ server key; the "no tacacs-server key" command deletes the key.

### 2. Configure TACACS+ server

Command	Explanation
Global Mode	
<b>tacacs-server authentication host</b> <b>&lt;IPaddress&gt; [[port {&lt;portNum&gt;}]</b> <b>[timeout &lt;seconds&gt;] [key &lt;string&gt;]</b> <b>[primary]]</b> <b>no tacacs-server authentication host</b> <b>&lt;IPaddress&gt;</b>	Configure the IP address, listening port number, the value of timeout timer and the key string of the TACACS+ server; the no form of this command deletes the TACACS+ authentication server.

## 3. Configure the TACACS+ authentication timeout time

Command	Explanation
Global Mode	
<b>tacacs-server timeout &lt;seconds&gt;</b> <b>no tacacs-server timeout</b>	Configure the authentication timeout for the TACACS+ server, the “ <b>no tacacs-server timeout</b> ” command restores the default configuration.

## 4. Configure the IP address of the TACACS+ NAS

Command	Explanation
Global Mode	
<b>tacacs-server nas-ipv4 &lt;ip-address&gt;</b> <b>no tacacs-server nas-ipv4</b>	To configure the source IP address for the TACACS+ packets for the switch.

## 55.3 TACACS+ Scenarios Typical Examples

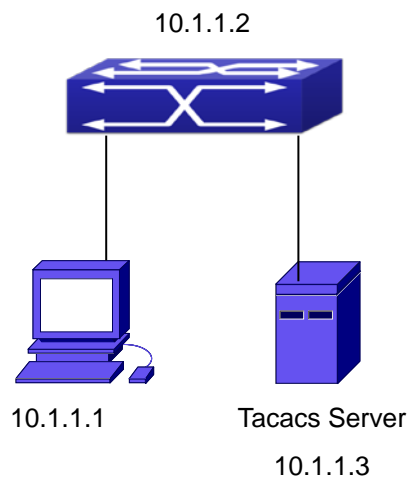

Figure 55-1 TACACS Configuration

A computer connects to a switch, of which the IP address is 10.1.1.2 and connected with a TACACS+ authentication server; IP address of the server is 10.1.1.3 and the authentication port is defaulted at 49, set telnet log on authentication of the switch as tacacs local, via using TACACS+ authentication server to achieve telnet user authentication.

```
Switch(config)#interface vlan 1
Switch(Config-if-vlan1)#ip address 10.1.1.2 255.255.255.0
Switch(Config-if-vlan1)#exit
Switch(config)#tacacs-server authentication host 10.1.1.3
Switch(config)#tacacs-server key test
```

```
Switch(config)#authentication line vty login tacacs
```

## 55.4 TACACS+ Troubleshooting

In configuring and using TACACS+, the TACACS+ may fail to authentication due to reasons such as physical connection failure or wrong configurations. The user should ensure the following:

- First good condition of the TACACS+ server physical connection.
- Second all interface and link protocols are in the UP state (use “**show interface**” command).
- Then ensure the TACACS+ key configured on the switch is in accordance with the one configured on TACACS+ server.
- Finally ensure to connect to the correct TACACS+ server.



---

# Chapter 56 RADIUS Configuration

## 56.1 Introduction to RADIUS

### 56.1.1 AAA and RADIUS Introduction

AAA is short for Authentication, Authorization and Accounting, it provide a consistency framework for the network management safely. According to the three functions of Authentication, Authorization, Accounting, the framework can meet the access control for the security network: which one can visit the network device, which access-level the user can have and the accounting for the network resource.

RADIUS (Remote Authentication Dial In User Service) is a kind of distributed and client/server protocol for information exchange. The RADIUS client is usually used on network appliance to implement AAA in cooperation with 802.1x protocol. The RADIUS server maintains the database for AAA, and communicates with the RADIUS client through RADIUS protocol. The RADIUS protocol is the most common used protocol in the AAA framework.

### 56.1.2 Message structure for RADIUS

The RADIUS protocol uses UDP to deliver protocol packets. The packet format is shown below.

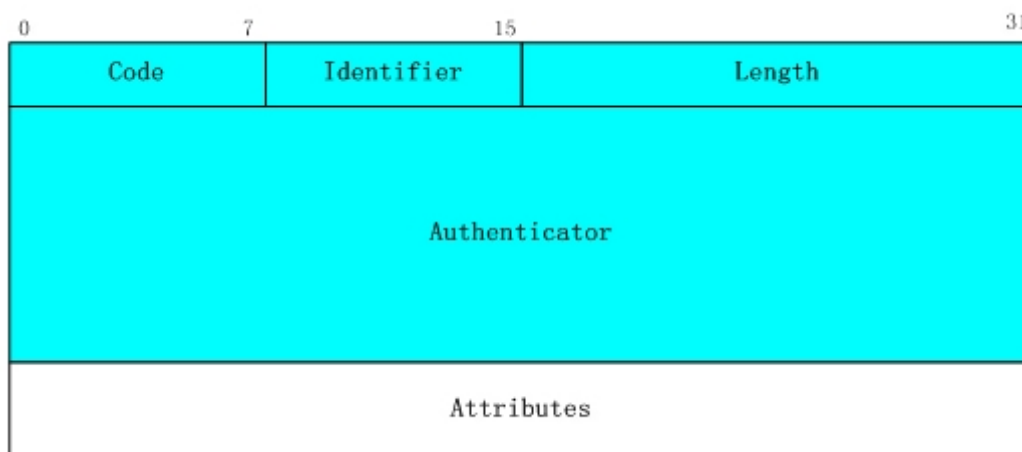

**Figure 56-1** Message structure for RADIUS

Code field(1octets): is the type of the RADIUS packet. Available value for the Code field is shown below:

- 1 · Access-Request
- 2 · Access-Accept
- 3 · Access-Reject
- 4 · Accounting-Request
- 5 · Accounting-Response
- 6 · Access-Challenge

---

Identifier field (1 octet): Identifier for the request and answer packets.

Length field (2 octets): The length of the overall RADIUS packet, including Code, Identifier, Length, Authenticator and Attributes

Authenticator field (16 octets): used for validation of the packets received from the RADIUS server. Or it can be used to carry encrypted passwords. This field falls into two kinds: the Request Authenticator and the Response Authenticator.

Attribute field: used to carry detailed information about AAA. An Attribute value is formed by Type, Length, and Value fields.

- Type field (1 octet), the type of the attribute value, which is shown as below:

Property	Type of property	Property	Type of property
1	User-Name	23	Framed-IPX-Network
2	User-Password	24	State
3	CHAP-Password	25	Class
4	NAS-IP-Address	26	Vendor-Specific
5	NAS-Port	27	Session-Timeout
6	Service-Type	28	Idle-Timeout
7	Framed-Protocol	29	Termination-Action
8	Framed-IP-Address	30	Called-Station-Id
9	Framed-IP-Netmask	31	Calling-Station-Id
10	Framed-Routing	32	NAS-Identifier
11	Filter-Id	33	Proxy-State
12	Framed-MTU	34	Login-LAT-Service
13	Framed-Compression	35	Login-LAT-Node
14	Login-IP-Host	36	Login-LAT-Group
15	Login-Service	37	Framed-AppleTalk-Link
16	Login-TCP-Port	38	Framed-AppleTalk-Network
17	(unassigned)	39	Framed-AppleTalk-Zone
18	Reply-Message	40-59	(reserved for accounting)
19	Callback-Number	60	CHAP-Challenge
20	Callback-Id	61	NAS-Port-Type
21	(unassigned)	62	Port-Limit
22	Framed-Route	63	Login-LAT-Port

- Length field (1 octet), the length in octets of the attribute including Type, Length and Value fields.
- Value field, value of the attribute whose content and format is determined by the type and length of the attribute.

---

## 56.2 RADIUS Configuration Task List

- 1 · Enable the authentication and accounting function.
- 2 · Configure the RADIUS authentication key.
- 3 · Configure the RADIUS server.
- 4 · Configure the parameter of the RADIUS service.
- 5 · Configure the IP address of the RADIUS NAS.

### 1. Enable the authentication and accounting function.

Command	Explanation
Global Mode	
<b>aaa enable</b> <b>no aaa enable</b>	To enable the AAA authentication function. The no form of this command will disable the AAA authentication function.
<b>aaa-accounting enable</b> <b>no aaa-accounting enable</b>	To enable AAA accounting. The no form of this command will disable AAA accounting.
<b>aaa-accounting update {enable/disable}</b>	Enable or disable the update accounting function.

### 2. Configure the RADIUS authentication key.

Command	Explanation
Global Mode	
<b>radius-server key &lt;string&gt;</b> <b>no radius-server key</b>	To configure the encryption key for the RADIUS server. The no form of this command will remove the configured key.

### 3. Configure the RADIUS server.

Command	Explanation
Global Mode	
<b>radius-server authentication host</b> <b>{ &lt;IPaddress&gt;   &lt;IPv6address&gt; } [[port</b> <b>{&lt;portNum&gt;}] [key &lt;string&gt;] [primary]</b> <b>[access-mode {dot1x telnet}]</b> <b>no radius-server authentication host</b> <b>&lt;IPaddress&gt;</b>	Specifies the IP address and listening port number, cipher key, whether be primary server or not and access mode for the RADIUS server; the no command deletes the RADIUS authentication server.

<b>radius-server accounting host</b> {<ipv4-address>   <ipv6-address>} [port <port-number>] [key <string>] [primary] <b>no radius-server accounting host</b> {<ipv4-address> / <ipv6-address>}	Specifies the IPv4/IPv6 address and the port number, whether be primary server for RADIUS accounting server; the no command deletes the RADIUS accounting server.
--	---

#### 4. Configure the parameter of the RADIUS service

Command	Explanation
Global Mode	
<b>radius-server dead-time &lt;minutes&gt;</b> <b>no radius-server dead-time</b>	To configure the interval that the RADIUS becomes available after it is down. The no form of this command will restore the default configuration.
<b>radius-server retransmit &lt;retries&gt;</b> <b>no radius-server retransmit</b>	To configure retry times for the RADIUS packets. The no form of this command restores the default configuration.
<b>radius-server timeout &lt;seconds&gt;</b> <b>no radius-server timeout</b>	To configure the timeout value for the RADIUS server. The no form of this command will restore the default configuration.
<b>radius-server accounting-interim-update timeout &lt;seconds&gt;</b> <b>no radius-server accounting-interim-update timeout</b>	To configure the update interval for accounting. The no form of this command will restore the default configuration.

#### 5. Configure the IP address of the RADIUS NAS

Command	Explanation
Global Mode	
<b>radius nas-ipv4 &lt;ip-address&gt;</b> <b>no radius nas-ipv4</b>	To configure the source IP address for the RADIUS packets for the switch.
<b>radius nas-ipv6 &lt;ipv6-address&gt;</b> <b>no radius nas-ipv6</b>	To configure the source IPv6 address for the RADIUS packets for the switch.

---

## 56.3 RADIUS Typical Examples

### 56.3.1 IPv4 Radius Example

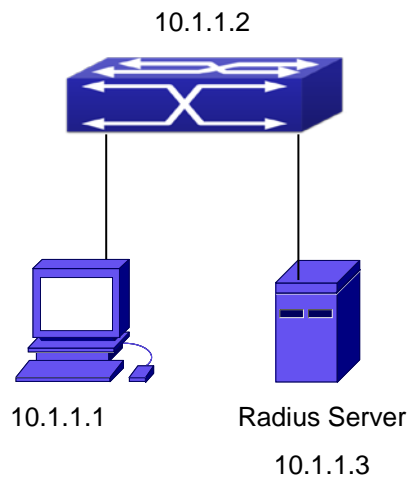

**Figure 56-2** The Topology of IEEE802.1x configuration

A computer connects to a switch, of which the IP address is 10.1.1.2 and connected with a RADIUS authentication server without Ethernet1/0/2; IP address of the server is 10.1.1.3 and the authentication port is defaulted at 1812, accounting port is defaulted at 1813.

Configure steps as below:

```
Switch(config)#interface vlan 1
Switch(Config-if-vlan1)#ip address 10.1.1.2 255.255.255.0
Switch(Config-if-vlan1)#exit
Switch(config)#radius-server authentication host 10.1.1.3
Switch(config)#radius-server accounting host 10.1.1.3
Switch(config)#radius-server key test
Switch(config)#aaa enable
Switch(config)#aaa-accounting enable
```

---

## 56.3.2 IPv6 RADIUS Example

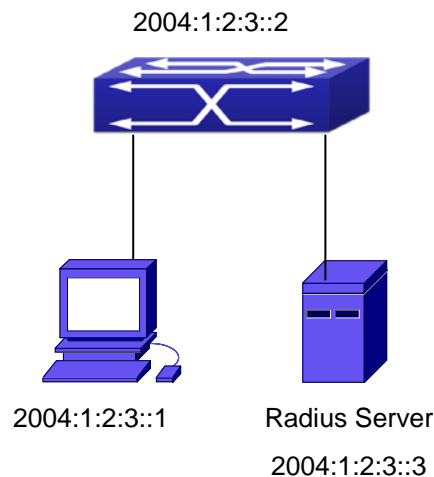

**Figure 56-3** The Topology of IPv6 Radius configuration

A computer connects to a switch, of which the IP address is 2004:1:2:3::2 and connected with a RADIUS authentication server without Ethernet1/2; IP address of the server is 2004:1:2:3::3 and the authentication port is defaulted at 1812, accounting port is defaulted at 1813.

Configure steps as below:

```
Switch(config)#interface vlan 1
Switch(Config-if-vlan1)#ipv6 address 2004:1:2:3::2/64
Switch(Config-if-vlan1)#exit
Switch(config)#radius-server authentication host 2004:1:2:3::3
Switch(config)#radius-server accounting host 2004:1:2:3::3
Switch(config)#radius-server key test
Switch(config)#aaa enable
Switch(config)#aaa-accounting enable
```

## 56.4 RADIUS Troubleshooting

In configuring and using RADIUS, the RADIUS may fail to authentication due to reasons such as physical connection failure or wrong configurations. The user should ensure the following:

- First make sure good condition of the RADIUS server physical connection;
- Second all interface and link protocols are in the UP state (use “**show interface**” command)
- Then ensure the RADIUS key configured on the switch is in accordance with the one configured on RADIUS server;
- Finally ensure to connect to the correct RADIUS server

If the RADIUS authentication problem remains unsolved, please use **debug aaa** and other debugging command and copy the DEBUG message within 3 minutes, send the recorded message to the technical server center of our company.

---

# Chapter 57 SSL Configuration

## 57.1 Introduction to SSL

As the computer networking technology spreads, the security of the network has been taking more and more important impact on the availability and the usability of the networking application. The network security has become one of the greatest barriers of modern networking applications.

To protect sensitive data transferred through Web, Netscape introduced the Secure Socket Layer – SSL protocol, for its Web browser. Up till now, SSL 2.0 and 3.0 has been released. SSL 2.0 is obsolete because of security problems, and it is not supported on the switches of Network. The SSL protocol uses the public-key encryption, and has become the industry standard for secure communication on internet for Web browsing. The Web browser integrates HTTP and SSL to realize secure communication.

SSL is a safety protocol to protect private data transmission on the Internet. SSL protocols are designed for secure transmission between the client and the server, and authentication both at the server sides and optional client. SSL protocols must build on reliable transport layer (such as TCP). SSL protocols are independent for application layer. Some protocols such as HTTP, FTP, TELNET and so on, can build on SSL protocols transparently. The SSL protocol negotiates for the encryption algorithm, the encryption key and the server authentication before data is transmitted. Ever since the negotiation is done, all the data being transferred will be encrypted.

Via above introduction, the security channel is provided by SSL protocols have below three characteristics:

- Privacy. First they encrypt the suite through negotiation, then all the messages be encrypted.
- Affirmation. Though the client authentication of the conversational is optional, but the server is always authenticated.
- Reliability. The message integrity inspect is included in the sending message (use MAC).

### 57.1.1 Basic Element of SSL

The basic strategy of SSL provides a safety channel for random application data forwarding between two communication programs. In theory, SSL connect is similar with encrypt TCP connect. The position of SSL protocol is under application layer and on the TCP. If the mechanism of the data forwarding in the lower layer is reliable, the data read-in the network will be forwarded to the other program in sequence, lose packet and re-forwarding will not appear. A lot of transmission protocols can provide such kind of service in theory, but in actual application, SSL is almost running on TCP, and not running on UDP and IP directly.

When web function is running on the switch and client visit our web site through the internet browser, we can use SSL function. The communication between client and switch through SSL connect can improve the security.

Firstly, SSL should be enabled on the switch. When the client tries to access the switch through https method, a SSL session will be set up between the switch and the client. When the SSL session has been set up, all the data transmission in the application layer will be encrypted.

SSL handshake is done when the SSL session is being set up. The switch should be able to provide certification keys. Currently the keys provided by the switch are not the formal certification keys issued by official authentic, but the private certification keys generated by SSL software under Linux which may not be recognized by the web browser. With regard to the switch application, it is not necessary to apply for a formal SSL certification key. A private certification key is enough to make the communication safe between the users and the switch. Currently it is not required that the client is able to check the validation of the certification key. The encryption key and the encryption method should be negotiated during the handshake period of the session which will be then used for data encryption.

SSL session handshake process:

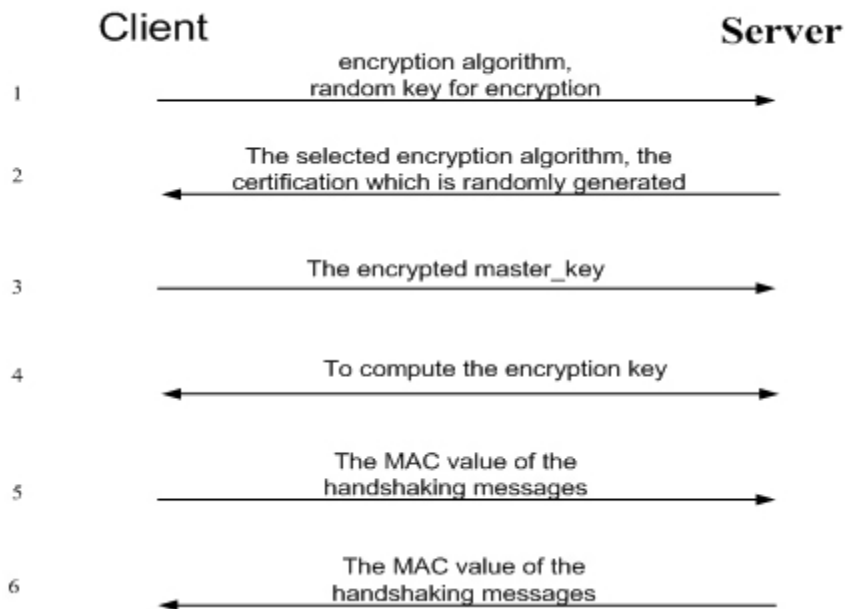

## 57.2 SSL Configuration Task List

1. Enable/disable SSL function
2. Configure/delete port number by SSL used
3. Configure/delete secure cipher suite by SSL used
4. Maintenance and diagnose for the SSL function

### 1. Enable/disable SSL function

Command	Explanation
Global Mode	
<b>ip http secure-server</b> <b>no ip http secure-server</b>	Enable/disable SSL function.



---

## 2. Configure/delete port number by SSL used

Command	Explanation
Global Mode	
<b>ip http secure-port &lt;port-number&gt;</b> <b>no ip http secure-port</b>	Configure port number by SSL used, the “ <b>no ip http secure-port</b> ” command deletes the port number.

## 3. Configure/delete secure cipher suite by SSL used

Command	Explanation
Global Mode	
<b>ip http secure-ciphersuite</b> <b>{des-cbc3-sha rc4-128-sha </b> <b>des-cbc-sha}</b> <b>no ip http secure-ciphersuite</b>	Configure/delete secure cipher suite by SSL used.

## 4. Maintenance and diagnose for the SSL function

Command	Explanation
Admin Mode or Configuration Mode	
<b>show ip http secure-server status</b>	Show the configured SSL information.
<b>debug ssl</b> <b>no debug ssl</b>	Open/close the DEBUG for SSL function.

## 57.3 SSL Typical Example

When the Web function is enabled on the switch, SSL can be configured for users to access the web interface on the switch. If the SSL has been configured, communication between the client and the switch will be encrypted through SSL for safety.

Firstly, SSL should be enabled on the switch. When the client tries to access the switch through https method, a SSL session will be set up between the switch and the client. When the SSL session has been set up, all the data transmission in the application layer will be encrypted.

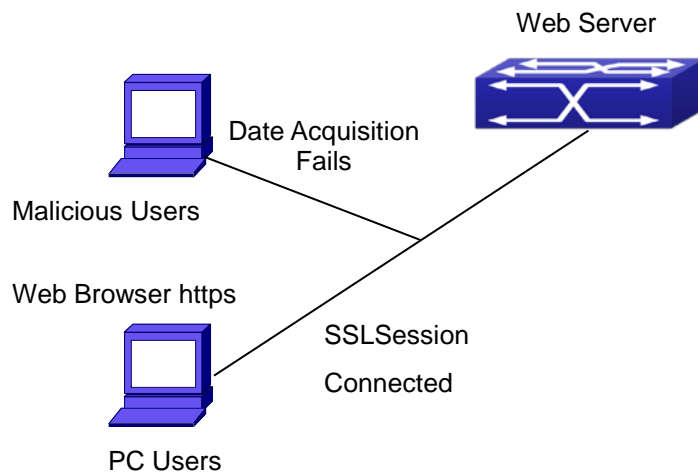

Configuration on the switch:

```
Switch(config)# ip http secure-server
Switch(config)# ip http secure-port 1025
Switch(config)# ip http secure-ciphersuite rc4-128-sha
```

## 57.4 SSL Troubleshooting

In configuring and using SSL, the SSL function may fail due to reasons such as physical connection failure or wrong configurations. The user should ensure the following:

- First good condition of the physical connection;
- Second all interface and link protocols are in the UP state (use “show interface” command);
- Then, make sure SSL function is enabled (use ip http secure-server command );
- Don't use the default port number if configured port number, pay attention to the port number when input the web wide;
- If SSL is enabled, SSL should be restarted after changes on the port configuration and encryption configuration;
- IE 7.0 or above should be used for use of des-cbc-sha;
- If the SSL problems remain unsolved after above try, please use debug SSL and other debugging command and copy the DEBUG message within 3 minutes, send the recorded message to technical server center of our company.

---

# Chapter 58 IPv6 Security RA Configuration

## 58.1 Introduction to IPv6 Security RA

In IPv6 networks, the network topology is generally comprised of routers, layer-two switches and IPv6 hosts. Routers usually advertise RA, including link prefix, link MTU and other information, when the IPv6 hosts receive RA, they will create link address, and set the default router as the one sending RA in order to implement IPv6 network communication. If a vicious IPv6 host sends RA to cause that normal IPv6 users set the default router as the vicious IPv6 host user, the vicious user will be able to capture the information of other users, which will threaten the network security. Simultaneously, the normal users get incorrect address and will not be able to connect to the network. So, in order to implement the security RA function, configuring on the switch ports to reject vicious RA messages is necessary, thus to prevent forwarding vicious RA to a certain extent and to avoid affecting the normal operation of the network.

## 58.2 IPv6 Security RA Configuration Task Sequence

1. Globally enable IPv6 security RA
2. Enable IPv6 security RA on a port
3. Display and debug the relative information of IPv6 security RA

### 1. Globally enable IPv6 security RA

Command	Explanation
Global Configuration Mode	
<b>ipv6 security-ra enable</b> <b>no ipv6 security-ra enable</b>	Globally enable and disable IPv6 security RA.

### 2. Enable IPv6 security RA on a port

Command	Explanation
Port Configuration Mode	
<b>ipv6 security-ra enable</b> <b>no ipv6 security-ra enable</b>	Enable and disable IPv6 security RA in port configuration mode.

### 3. Display and debug the relative information of IPv6 security RA

Command	Explanation
Admin Mode	

<b>debug ipv6 security-ra</b> <b>no debug ipv6 security-ra</b>	Enable the debug information of IPv6 security RA module, the no operation of this command will disable the output of debug information of IPv6 security RA.
<b>show ipv6 security-ra [interface &lt;interface-list&gt;]</b>	Display the distrust port and whether globally security RA is enabled.

## 58.3 IPv6 Security RA Typical Examples

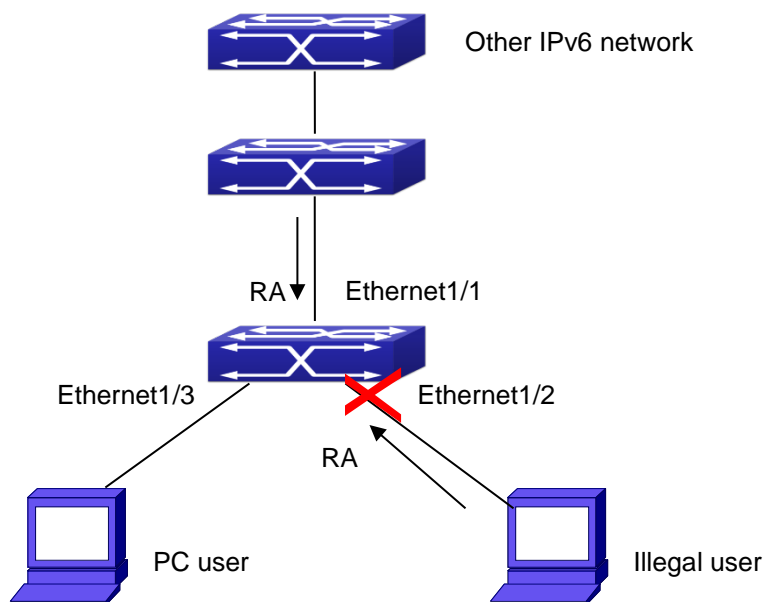

Instructions: if the illegal user in the graph advertises RA, the normal user will receive the RA, set the default router as the vicious IPv6 host user and change its own address. This will cause the normal user to not be able to connect the network. We want to set security RA on the 1/0/2 port of the switch, so that the RA from the illegal user will not affect the normal user.

Switch configuration task sequence:

```
Switch#config
Switch(config)#ipv6 security-ra enable
Switch(Config-If-Ethernet1/0/2)# ipv6 security-ra enable
```

## 58.4 IPv6 Security RA Troubleshooting Help

The function of IPv6 security RA is quite simple, if the function does not meet the expectation after configuring IPv6 security RA:

- Check if the switch is correctly configured.
- Check if there are rules conflicting with security RA function configured on the switch, this kind of rules will cause RA messages to be forwarded..

---

# Chapter 59 VLAN-ACL Configuration

## 59.1 Introduction to VLAN-ACL

The user can configure ACL policy to VLAN to implement the accessing control of all ports in VLAN, and VLAN-ACL enables the user to expediently manage the network. The user only needs to configure ACL policy in VLAN, the corresponding ACL action can takes effect on all member ports of VLAN, but it does not need to solely configure on each member port.

When VLAN ACL and Port ACL are configured at the same time, the principle of denying firstly is used. When the packets match VLAN ACL and Port ACL at the same time, as long as one rule is drop, then the final action is drop.

Egress ACL can implement the filtering of the packets on egress and ingress direction, the packets match the specific rules can be allowed or denied. ACL can support IP ACL, MAC ACL, MAC-IP ACL, IPv6 ACL. Ingress direction of VLAN can bind four kinds of ACL at the same time, there are four resources on egress direction of VLAN, IP ACL and MAC ACL engage one resource severally, MAC-IP ACL and IPv6 ACL engage two resources severally, so egress direction of VLAN can not bind four kinds of ACL at the same time. When binding three kinds of ACL at the same time, it should be the types of IP, MAC, MAC-IP or IP, MAC, IPv6. When binding two kinds of ACL at the same time, any combination of ACL type is valid. Each type can only apply one on a VLAN.

## 59.2 VLAN-ACL Configuration Task List

1. Configure VLAN-ACL of IP type
2. Configure VLAN-ACL of MAC type
3. Configure VLAN-ACL of MAC-IP
4. Configure VLAN-ACL of IPv6 type
5. Show configuration and statistic information of VLAN-ACL
6. Clear statistic information of VLAN-ACL

### 1. Configure VLAN-ACL of IP type

Command	Explanation
Global mode	
<b>vacl ip access-group</b> {<1-299>   WORD} {in   out} [traffic-statistic] vlan WORD <b>no vacl ip access-group</b> {<1-299>   WORD} {in   out} vlan WORD	Configure or delete IP VLAN-ACL.

## 2. Configure VLAN-ACL of MAC type

Command	Explanation
Global mode	
<b>vacl mac access-group</b> {<700-1199>   WORD} {in   out} [traffic-statistic] vlan WORD <b>no vacl mac access-group</b> {<700-1199>   WORD} {in   out} vlan WORD	Configure or delete MAC VLAN-ACL.

## 3. Configure VLAN-ACL of MAC-IP

Command	Explanation
Global mode	
<b>vacl mac-ip access-group</b> {<3100-3299>   WORD} {in   out} [traffic-statistic] vlan WORD <b>no vacl mac-ip access-group</b> {<3100-3299>   WORD} {in   out} vlan WORD	Configure or delete MAC-IP VLAN-ACL.

## 4. Configure VLAN-ACL of IPv6 type

Command	Explanation
Global mode	
<b>vacl ipv6 access-group</b> (<500-699>   WORD) {in   out} (traffic-statistic) vlan WORD <b>no ipv6 access-group</b> {<500-699>   WORD} {in   out} vlan WORD	Configure or delete IPv6 VLAN-ACL.

## 5. Show configuration and statistic information of VLAN-ACL

Command	Explanation
Admin mode	
<b>show vacl</b> [in   out] vlan [<vlan-id>]	Show the configuration and the statistic information of VACL.

## 6. Clear statistic information of VLAN-ACL

Command	Explanation
Admin mode	
<b>clear vacl</b> [in   out] statistic vlan [<vlan-id>]	Clear the statistic information of VACL.

## 59.3 VLAN-ACL Configuration Example

A company's network configuration is as follows, all departments are divided by different VLANs, technique department is Vlan1, finance department is Vlan2. It is required that technique department can access the outside network at timeout, but finance department are not allowed to access the outside network at any time for the security. Then the following policies are configured:

- Set the policy VACL\_A for technique department. At timeout they can access the outside network, the rule as permit, but other times the rule as deny, and the policy is applied to Vlan1.
- Set the policy VACL\_B of ACL for finance department. At any time they can not access the outside network, but can access the inside network with no limitation, and apply the policy to Vlan2.

Network environment is shown as below:

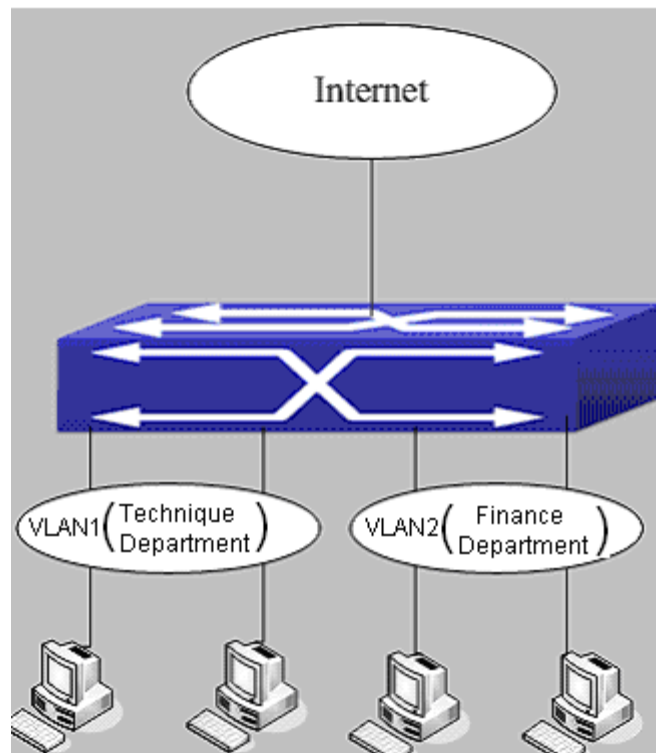

Figure 59-1 VLAN-ACL configuration example

Configuration example:

- 1) First, configure a timerange, the valid time is the working hours of working day:

```
Switch(config)#time-range t1
Switch(config-time-range-t1)#periodic weekdays 9:00:00 to 12:00:00
Switch(config-time-range-t1)#periodic weekdays 13:00:00 to 18:00:00
```

- 2) Configure the extended acl\_a of IP, at working hours it only allows to access the resource within the internal network (such as 192.168.0.255).

```
Switch(config)# ip access-list extended vacl_a
Switch(config-ip-ext-nacl-vacl_a)# permit ip any-source 192.168.0.0 0.0.0.255 time-range t1
```

```
Switch(config-ip-ext-nacl-vacl_a)# deny ip any-source any-destination time-range t1
```

3) Configure the extended acl\_b of IP, at any time it only allows to access resource within the internal network (such as 192.168.1.255).

```
Switch(config)#ip access-list extended vacl_b  
Switch(config-ip-ext-nacl-vacl_a)# permit ip any-source 192.168.1.0 0.0.0.255  
Switch(config-ip-ext-nacl-vacl_a)# deny ip any-source any-destination
```

4) Apply the configuration to VLAN

```
Switch(config)#vacl ip access-group vacl_a in vlan 1  
Switch(config)#vacl ip access-group vacl_b in vlan 2
```

## 59.4 VLAN-ACL Troubleshooting

- When VLAN ACL and Port ACL are configured at the same time, the principle of denying firstly is used. When the packets match VLAN ACL and Port ACL at the same time, as long as one rule is drop, then the final action is drop.
- Each ACL of different types can only apply one on a VLAN, such as the basic IP ACL, each VLAN can applies one only.



---

# Chapter 60 MAB Configuration

## 60.1 Introduction to MAB

In actual network existing the device which can not install the authentication client, such as printer, PDA devices, they can not process 802.1x authentication. However, to access the network resources, they need to use MAB authentication to replace 802.1x authentication.

MAB authentication is a network accessing authentication method based on the accessing port and the MAC address of MAB user. The user needn't install any authentication client, after the authentication device receives ARP packets sent by MAB user, it will authenticate the MAC address of the MAB user and there is the corresponding authentication information in the authentication server, the matched packets of the port and the source MAC are allowed to pass when the authentication is successful. MAB user didn't need to input the username and password manually in the process of authentication.

At present, MAB authentication device only supports RADIUS authentication method. There is the selection method for the authentication username and password: use the MAC address of the MAB user as the username and password, or the fixed username and password (all users use the configured username and password to authenticate).

## 60.2 MAB Configuration Task List

MAB Configuration Task List:

1. Enable MAB function
  - 1) Enable global MAB function
  - 2) Enable port MAB function
2. Configure MAB authentication username and password
3. Configure MAB parameters
  - 1) Configure guest-vlan
  - 2) Configure the binding-limit of the port
  - 3) Configure the reauthentication time
  - 4) Configure the offline detection time
  - 5) Configure other parameters

### 1. Enable MAB function

Command	Explanation
Global Mode	
<b>mac-authentication-bypass enable</b> <b>no mac-authentication-bypass enable</b>	Enable the global MAB authentication function.
Port Mode	

<b>mac-authentication-bypass enable</b> <b>no mac-authentication-bypass enable</b>	Enable the port MAB authentication function.
---	--

## 2. Configure MAB authentication username and password

Command	Explanation
Global Mode	
<b>mac-authentication-bypass</b> <b>username-format {mac-address   {fixed</b> <b>username WORD password WORD}}</b>	Set the authentication mode of MAB authentication function.

## 3. Configure MAB parameters

Command	Explanation
Port Mode	
<b>mac-authentication-bypass guest-vlan</b> <b>&lt;1-4094&gt;</b> <b>no mac-authentication-bypass guest-vlan</b>	Set guset vlan of MAB authentication, only Hybrid port uses this command, it is not take effect on access port.
<b>mac-authentication-bypass binding-limit</b> <b>&lt;1-100&gt;</b> <b>no mac-authentication-bypass</b> <b>binding-limit</b>	Set the max MAB binding-limit of the port.
Global Mode	
<b>mac-authentication-bypass timeout</b> <b>reauth-period &lt;1-3600&gt;</b> <b>no mac-authentication-bypass timeout</b> <b>reauth-period</b>	Set the reauthentication interval after the authentication is unsuccessful.
<b>mac-authentication-bypass timeout</b> <b>offline-detect ( 0   &lt;60-7200&gt; )</b> <b>no mac-authentication-bypass timeout</b> <b>offline-detect</b>	Set offline detection interval.
<b>mac-authentication-bypass timeout</b> <b>quiet-period &lt;1-60&gt;</b> <b>no mac-authentication-bypass timeout</b> <b>quiet-period</b>	Set quiet-period of MAB authentication.
<b>mac-authentication-bypass timeout</b> <b>stale-period &lt;0-60&gt;</b> <b>no mac-authentication-bypass timeout</b> <b>stale-period</b>	Set the time that delete the binding after the port is down.

<b>mac-authentication-bypass timeout</b> <b>linkup-period &lt;0-30&gt;</b> <b>no mac-authentication-bypass timeout</b> <b>linkup-period</b>	To obtain IP again, set the interval of down/up when MAB binding is changing into VLAN.
<b>mac-authentication-bypass</b> <b>spoofing-garp-check enable</b> <b>no mac-authentication-bypass</b> <b>spoofing-garp-check enable</b>	Enable the spoofing-garp-check function, MAB function will not deal with spoofing-garp any more; the no command disables the function.
<b>authentication mab {radius   none}</b> <b>no authentication mab</b>	Configure the authentication mode and priority of MAC address, the no command restores the default authentication mode.

## 60.3 MAB Example

Example:

The typical example of MAB authentication function:

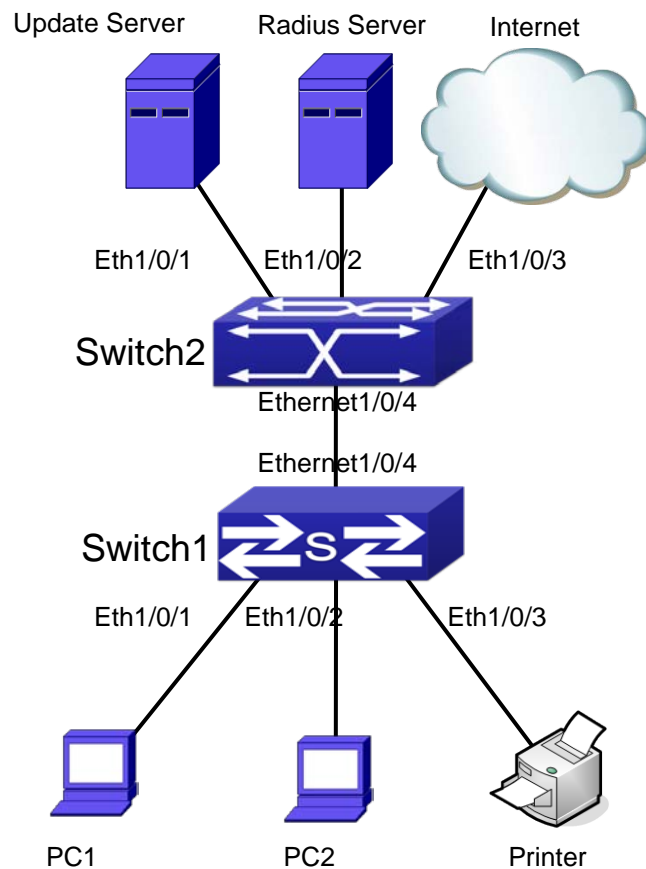

Figure 60-1 MAB application

---

Switch1 is a layer 2 accessing switch, Switch2 is a layer 3 aggregation switch.

Ethernet 1/0/1 is an access port of Switch1, connects to PC1, it enables 802.1x port-based function and configures guest vlan as vlan8.

Ethernet 1/0/2 is a hybrid port, connects to PC2, native vlan of the port is vlan1, and configures guest vlan as vlan8, it joins in vlan1, vlan8 and vlan10 with untag method and enables MAB function.

Ethernet 1/0/3 is an access port, connects to the printer and enables MAB function.

Ethernet 1/0/4 is a trunk port, connects to Switch2.

Ethernet 1/0/4 is a trunk port of Switch2, connects to Switch1.

Ethernet 1/0/1 is an access port, belongs to vlan8, connects to update server to download and upgrade the client software.

Ethernet 1/0/2 is an access port, belongs to vlan9, connects to radius server which configure auto vlan as vlan10.

Ethernet 1/0/3 is an access port, belongs to vlan10, connects to external internet resources.

To implement this application, the configuration is as follows:

Switch1 configuration:

- (1) Enable 802.1x and MAB authentication function globally, configure username and password of MAB authentication and radius-server address

```
Switch(config)# dot1x enable
Switch(config)# mac-authentication-bypass enable
Switch(config)# mac-authentication-bypass username-format fixed username mabuser password mabpwd
Switch(config)#vlan 8-10
Switch(config)#interface vlan 9
Switch(config-if-vlan9)ip address 192.168.61.9 255.255.255.0
Switch(config-if-vlan9)exit
Switch(config)#radius-server authentication host 192.168.61.10
Switch(config)#radius-server accounting host 192.168.61.10
Switch(config)#radius-server key test
Switch(config)#aaa enable
Switch(config)#aaa-accounting enable
```

- (2) Enable the authentication function of each port

```
Switch(config)#interface ethernet 1/0/1
Switch(config-if-ethernet1/0/1)#dot1x enable
Switch(config-if-ethernet1/0/1)# dot1x port-method portbased
Switch(config-if-ethernet1/0/1)# dot1x guest-vlan 8
Switch(config-if-ethernet1/0/1)#exit

Switch(config)#interface ethernet 1/0/2
Switch(config-if-ethernet1/0/2)# switchport mode hybrid
```

```
Switch(config-if-ethernet1/0/2)# switchport hybrid native vlan 1
Switch(config-if-ethernet1/0/2)# switchport hybrid allowed vlan 1;8;10 untag
Switch(config-if-ethernet1/0/2)# mac-authentication-bypass enable
Switch(config-if-ethernet1/0/2)# mac-authentication-bypass enable guest-vlan 8
Switch(config-if-ethernet1/0/2)#exit

Switch(config)#interface ethernet 1/0/3
Switch(config-if-ethernet1/0/3)# switchport mode access
Switch(config-if-ethernet1/0/3)# mac-authentication-bypass enable
Switch(config-if-ethernet1/0/3)#exit

Switch(config)#interface ethernet 1/0/4
Switch(config-if-ethernet1/0/4)# switchport mode trunk
```

## 60.4 MAB Troubleshooting

If there is any problem happens when using MAB function, please check whether the problem is caused by the following reasons:

- Make sure global and port MAB function are enabled;
- Make sure the correct username and password of MAB authentication are used;
- Make sure the radius-server configuration is correct. Complete MAB offline-detect through query whether dynamic MAC is exist. Do not delete the binding if the MAC address exists in MAC address table. The actual offline time without the traffic is 1-2 MAC aging period add 0-1 MAB offline-detect time.

---

# Chapter 61 PPPoE Intermediate Agent Configuration

## 61.1 Introduction to PPPoE Intermediate Agent

### 61.1.1 Brief Introduction to PPPoE

PPPoE (Point to Point Protocol over Ethernet) is a protocol that apply PPP protocol to Ethernet. PPP protocol is a link layer protocol and supply a communication method of point-to-point, it is usually selected by host dial-up link, for example the link is line dial-up. PPP protocol is applied to Ethernet that means PPPoE protocol makes many hosts of Ethernet to connect a remote access collector through one or multiple bridge devices. If the remote access collector is broadband access server (BAS), it can supply broadband access and accounting functions for these hosts, so PPPoE protocol is used to broadband access authentication of Ethernet usually.

### 61.1.2 Introduction to PPPoE IA

Along with broadband access technique is rapidly developed, broadband access network is also developing from strength to strength, but security problem gradually becomes the focus, so the clients or the access device and the network are faced with security problem (especially from the client) in the current access network. Traditional Ethernet user can not be identified, traced and located exactly, however in exoteric and controllable network, identification and location are the basic character and requirement for user, for example, when supplying the application that use user accounts to login, this method supplied by PPPoE Intermediate Agent can availably avoid user accounts embezzled.

There are two stages for PPPoE protocol work: discovery stage and session stage. Discovery stage is used to obtain MAC address of the remote server to establish a point-to-point link and a session ID with the server, and session stage uses this session ID to communicate. PPPoE Intermediate Agent only relates to discovery stage, so we simply introduce discovery stage.

There are four steps for discovery stage:

1. Client sends PADI packet: The first step, client uses broadcast address as destination address and broadcast PADI (PPPoE Active Discovery Initiation) packet to discover access collector in layer 2 network. Notice: This message may be sent to many access collector of the network.
2. Broadband Access Server responds PADO packet: The second step, server responds PADO (PPPoE Active Discovery Offer) packet to client according to the received source MAC address of PADI packet, the packet will take sever name and service name.
3. Client sends PADR packet: The third step, client selects a server to process the session according to the received PADO packet. It may receives many PADO packets for PADI message of the first step may be sent to many servers (select the server according to whether the service information of

PADO packet match with the service information needed by client). MAC address of the other end used for session will be known after server is selected, and send PADR (PPPoE Active Discovery Request) packet to it to announce server the session requirement.

4. Server responds PADS packet: The fourth step, server establishes a session ID according to the received PADR packet, this session ID will be sent to client through PADS (PPPoE Active Discovery Session-confirmation) packet, hereto PPPoE discovery stage is completed, enter session stage.

PADT (PPPoE Active Discovery Terminate) packet is an especial packet of PPPoE, its' Ethernet protocol number (0x8863) is the same as four packets above, so it can be considered a packet of discovery stage. To stop a PPPoE session, PADT may be sent at the discretional time of the session. (It can be sent by client or server)

PPPoE Intermediate Agent supplies a function that identify and locate the user. When passing network access device, PADI and PADR messages sent by client with the access link tag of this device at PPPoE discovery stage, so as to exactly identify and locate the user on server.

If the direct-link access device is LAN switch, the added information include: MAC, Slot ID, Port Index, Vlan ID, and so on. This function is implemented according to Migration to Ethernet-based DSL aggregation.

### 61.1.2.1 PPPoE Intermediate Agent Exchange Process

PPPoE Intermediate Agent exchange process is similar to PPPoE exchange process, for the first exchange process, the access link tag is added to PADI and PADR packets. The exchange process is as follows:

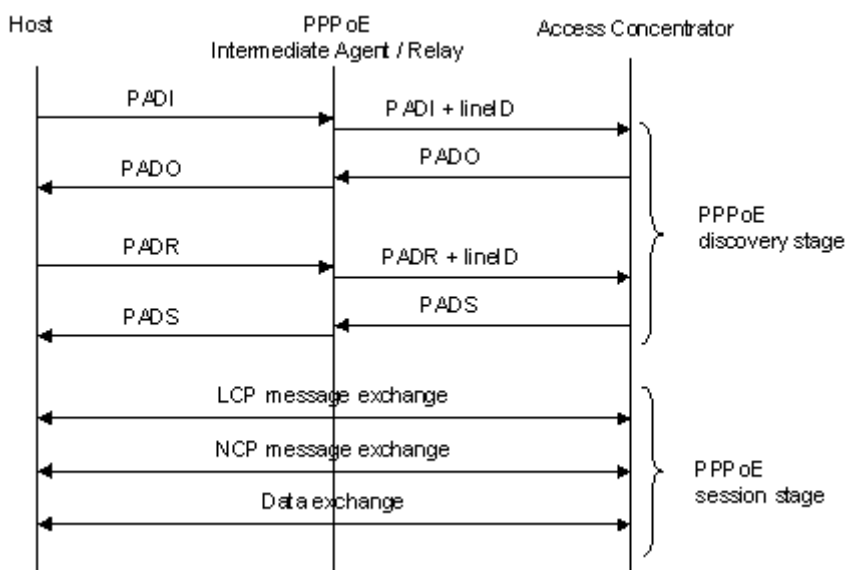

Figure 61-1 PPPoE IA protocol exchange process

### 61.1.2.2 PPPoE Packet Format

PPPoE packet format is as follows:

Ethernet II frame

Destination MAC	Source MAC	Type Field	PPPoE Data	CRC Check Sum
-----------------	------------	------------	------------	---------------

PPPoE data

Version	Type	Code	Session ID	Length Field	TLV1	.....	TLV N
---------	------	------	------------	--------------	------	-------	-------

TLV frame

Type	Length	Data
------	--------	------

Each field means the following:

Type field (2 bytes) of Ethernet II frame: The protocol sets type field value of PPPoE protocol packet as 0x8863 (include 5 kinds of packets in PPPoE discovery stage only), type field value of session stage as 0x8864.

PPPoE version field (4 bits): Specify the current PPPoE protocol version, the current version must be set as 0x1.

PPPoE type field (4 bits): Specify the protocol type, the current version must be set as 0x1.

PPPoE code field (1 byte): Specify the packet type. 0x09 means PADI packet, 0x07 means PADO packet, 0x19 means PADR packet, 0x65 means PADS packet, 0xa7 means PADT packet.

PPPoE session ID field (2 bytes): Specify the session ID.

PPPoE length field (2 bytes): Specify the sum of all TLV length.

TLV type field (2 bytes): A TLV frame means a TAG, type field means TAG type, the table is as follows.

TLV length field (2 bytes): Specify the length of TAG data field.

TLV data field (the length is not specified): Specify the transmitted data of TAG.

Tag Type	Tag Explanation
0x0000	The end of a series tag in PPPoE data field, it is saved for ensuring the version compatibility and is applied by some packets.
0x0101	Service name. Indicate the supplied services by network.
0x0102	Server name. When user receives the PADO response packet of AC, it can obtain the server name from the tag and select the corresponding server.
0x0103	Exclusive tag of the host. It is similar to tag field of PPPoE data packets and is used to match the sending and receiving end (Because broadcast network may exist many PPPoE data packets synchronously).
0x0104	AC-Cookies. It is used to avoid the vicious DOS attack.
0x0105	The identifier of vendor.
0x0110	Relay session ID. PPPoE data packet can be interrupted to other AC, this field is used to keep other connection.
0x0201	The error of service name. When the requested service name is not accepted by other end, the response packet will take this tag.
0x0202	The error of server name.
0x0203	Common error.

**Table 61-1** TAG value type of PPPoE



### 61.1.2.3 PPPoE Intermediate Agent Vendor Tag Frame

The following is the format of tag added by PPPoE IA, adding tag is the Uppermost function of PPPoE IA.

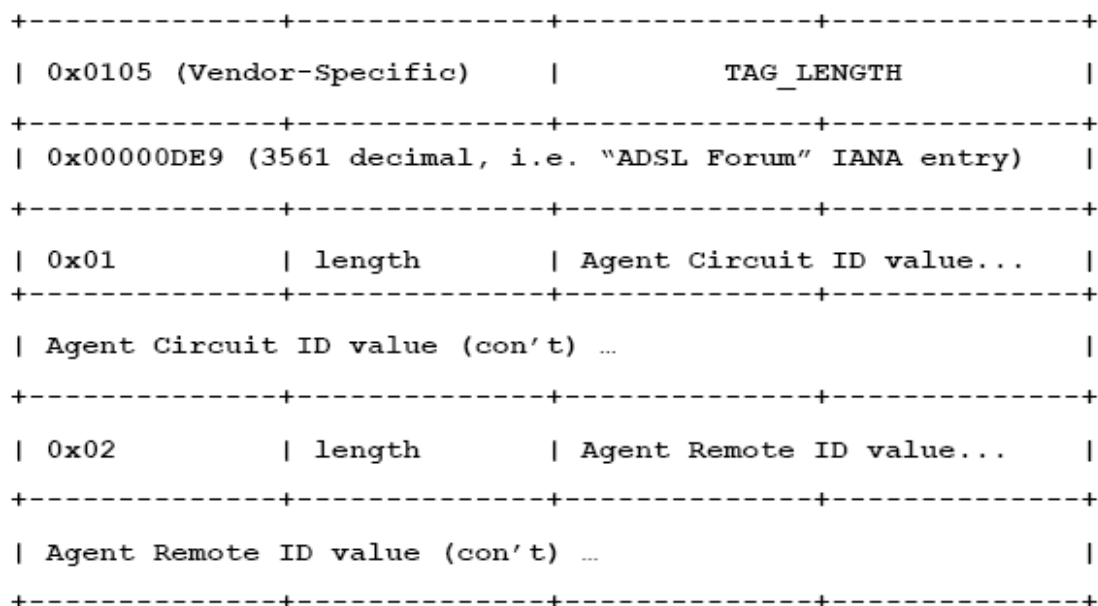

**Figure 61-2** PPPoE IA - vendor tag (4 bytes in each row)

Add TLV tag as 0x0105 for PPPoE IA, TAG\_LENGTH is length field of vendor tag; 0x00000DE9 is "ADSL Forum" IANA entry of the fixed 4 bytes; 0x01 is type field of Agent Circuit ID, length is length field and Agent Circuit ID value field; 0x02 is type field of Agent Remote ID, length is length field and Agent Remote ID value field.

PPPoE IA supplies a default circuit ID value, the default circuit ID (The figure in the following) includes 5 fields, ANI (Access Node Identifier) can be configured by user, its length is less than 47 bytes. If there is no ANI configured, MAC is accessed by default, occupy 6 bytes and use space symbol to comport, "eth" occupies 3 bytes and uses space symbol to comport, "Slot ID" occupies 2 bytes, use "/" to comport and occupy 1 byte, "Port Index" occupies 3 bytes, use "." to comport and occupy 1 byte, "Vlan ID" occupies 4 bytes, all fields use ASCII, user can configure circuit ID for each port according to requirement.

ANI (n byte)	Space ( 1byte)	eth (3 byte)	Space (1 byte)	Slot ID (2 byte)	/ (1byte)	Port Index (3 byte)	: (1 byte)	Vlan ID (4 byte)
-----------------	-------------------	-----------------	-------------------	---------------------	--------------	------------------------	---------------	---------------------

**Figure 61-3** Agent Circuit ID value

MAC of the access switch is the default remote ID value of PPPoE IA. remote ID value can be configured by user flexibly, the length is less than 63 bytes.

### 61.1.2.4 Trust Port of PPPoE Intermediate Agent

Discovery stage sends five kinds of packets, PADI and PADR packets sent by client to server, PADO and PADS packets sent by server to client, PADT packet can be sent by server or client.

In PPPoE IA, for security and reduce traffic, set a port connected server as trust port, set ports connected

client as untrust port, trust port can receive all packets, untrust port can receive only PADI, PADR and PADT packets which are sent to server. To ensure client operation is correct, it must set the port connected server as trust port, each access device has a trust port at least.

PPPoE IA vendor tag can not exist in PPPoE packets sent by server to client, so we can strip and forward these vendor tags if they exist in PPPoE packets. Strip function must be configured on trust port, enabling strip function is not take effect on untrust port.

## 61.2 PPPoE Intermediate Agent Configuration Task List

1. Enable global PPPoE Intermediate Agent
2. Enable port PPPoE Intermediate Agent

Command	Explanation
Global Mode	
<b>pppoe intermediate-agent</b> <b>no pppoe intermediate-agent</b>	Enable global PPPoE Intermediate Agent function.
<b>pppoe intermediate-agent access-node-id</b> <b>&lt;string&gt;</b> <b>no pppoe intermediate-agent</b> <b>access-node-id</b>	Configure access node ID field value of circuit ID in added vendor tag.
<b>pppoe intermediate-agent identifier-string</b> <b>&lt;string&gt; option { sp   sv   pv   spv }</b> <b>delimiter &lt;WORD&gt; [delimiter &lt;WORD&gt; ]</b> <b>no pppoe intermediate-agent</b> <b>identifier-string option delimiter</b>	Configure circuit-id in added vendor tag.
Port Mode	
<b>pppoe intermediate-agent</b> <b>no pppoe intermediate-agent</b>	Enable PPPoE Intermediate Agent function of port.
<b>pppoe intermediate-agent vendor-tag strip</b> <b>no pppoe intermediate-agent vendor-tag</b> <b>strip</b>	Set vendor tag strip function of port.
<b>pppoe intermediate-agent trust</b> <b>no pppoe intermediate-agent trust</b>	Set a port as trust port.
<b>pppoe intermediate-agent circuit-id</b> <b>&lt;string&gt;</b> <b>no pppoe intermediate-agent circuit-id</b>	Set circuit-id of port.
<b>pppoe intermediate-agent remote-id</b> <b>&lt;string&gt;</b> <b>no pppoe intermediate-agent remote-id</b>	Set remote-id of port.

---

## 61.3 PPPoE Intermediate Agent Typical Application

PPPoE Intermediate Agent typical application is as follows:

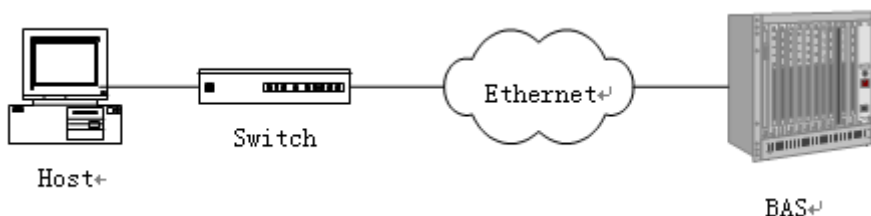

**Figure 61-4** PPPoE IA typical application

Both host and BAS server run PPPoE protocol, they are connected by layer 2 ethernet, switch enables PPPoE Intermediate Agent function.

Typical configuration (1) in the following:

Step1: Switch enables global PPPoE IA function, MAC as 0a0b0c0d0e0f.

```
Switch(config)# pppoe intermediate-agent
```

Step2: Configure port ethernet1/0/1 which connect server as trust port, and configure vendor tag strip function.

```
Switch(config-if-ethernet1/0/1)#pppoe intermediate-agent trust  
Switch(config-if-ethernet1/0/1)#pppoe intermediate-agent vendor-tag strip
```

Step3: Port ethernet1/0/2 of vlan1 and port ethernet1/0/3 of vlan 1234 enable PPPoE IA function of port.

```
Switch(config-if-ethernet1/0/2)#pppoe intermediate-agent  
Switch(config-if-ethernet1/0/3)#pppoe intermediate-agent
```

Step4: Configure pppoe intermediate-agent access-node-id as abcd.

```
Switch(config)#pppoe intermediate-agent access-node-id abcd
```

Step5: Configure circuit ID as aaaa, remote ID as xyz for port ethernet1/0/3.

```
Switch(config-if-ethernet1/0/3)#pppoe intermediate-agent circuit-id aaaa  
Switch (config-if-ethernet1/0/3)#pppoe intermediate-agent remote-id xyz
```

circuit-id value is "abcd eth 01/002:0001", remote-id value is "0a0b0c0d0e0f" for the added vendor tag of port ethernet1/0/2.

circuit-id value is "aaaa", remote-id value is "xyz" for the added vendor tag of port ethernet1/0/3.

---

Typical configuration (2) in the following:

Step1: Switch enables global PPPoE IA function, MAC as 0a0b0c0d0e0f.

```
Switch(config)#pppoe intermediate-agent
```

Step2: Configure port ethernet1/0/1 which connect server as trust port, and configure vendor tag strip function.

```
Switch(config-if-ethernet1/0/1)#pppoe intermediate-agent trust
Switch(config-if-ethernet1/0/1)#pppoe intermediate-agent vendor-tag strip
```

Step3: Port ethernet1/0/2 of vlan1 and port ethernet1/0/3 of vlan 1234 enable PPPoE IA function of port.

```
Switch(config-if-ethernet1/0/2)#pppoe intermediate-agent
Switch(config-if-ethernet1/0/3)#pppoe intermediate-agent
```

Step4: Configure pppoe intermediate-agent access-node-id as abcd.

```
Switch(config)#pppoe intermediate-agent access-node-id abcd
```

Step5: Configure pppoe intermediate-agent identifier-string as "efgh", combo mode as spv, delimiter of Slot ID and Port ID as "#", delimiter of Port ID and Vlan ID as "/".

```
Switch(config)#pppoe intermediate-agent identifier-string efgh option spv delimiter # delimiter /
```

Step6: Configure circuit-id value as bbbb on port ethernet1/0/2.

```
Switch(config-if-ethernet1/0/2)#pppoe intermediate-agent circuit-id bbbb
```

Step7: Configure remote-id as xyz on ethernet1/0/3.

```
Switch(config-if-ethernet1/0/3)#pppoe intermediate-agent remote-id xyz
```

circuit-id value is "bbbb", remote-id value is "0a0b0c0d0e0f" for the added vendor tag of port ethernet1/0/2.

circuit-id value is "efgh eth 01#003/1234", remote-id value is "xyz" for the added vendor tag of port ethernet1/0/3.

## 61.4 PPPoE Intermediate Agent Troubleshooting

- Only switch enables global PPPoE intermediate agent firstly, this function can be run on port.
- Configure a trust port at least, and this port can connect to server.
- vendor tag strip function must be configured by trust port.
- Circuit-id override priority is: pppoe intermediate-agent circuit-id < pppoe intermediate-agent identifier-string option delimiter < pppoe intermediate-agent access-node-id.

---

# Chapter 62 SAVI Configuration

## 62.1 Introduction to SAVI

SAVI (Source Address Validation Improvement) is a security authentication method that provides the granularity level of the node source address. It gets the trust node information (such as port, MAC address information), namely, anchor information by monitoring the interaction process of the relative protocol packets (such as ND protocol, DHCPv6 protocol) and using CPS (Control Packet Snooping) mechanism. After that, it binds the anchor information with the node source address and sends the corresponding filter rules, allow the packets which match the filter rules to pass only, so as to reach the aim that check the validity of node source address.

SAVI function includes ND Snooping function, DHCPv6 Snooping function and RA Snooping according to the protocol packet type. ND Snooping function is used to detect ND protocol packet, it sets IPv6 address binding obtained by nodes with the stateless address configuration. DHCPv6 Snooping function is used to detect DHCPv6 protocol packet, it sets IPv6 address binding obtained by nodes with the stateful address configuration. RA Snooping function is used to avoid the lawless node sending the spurious RA packet.

## 62.2 SAVI Configuration

SAVI configuration task list:

1. Enable or disable SAVI function
2. Enable or disable application scene function for SAVI
3. Configure SAVI binding function
4. Configure the global max-dad-delay for SAVI
5. Configure the global max-dad-prepare-delay for SAVI
6. Configure the global max-slaac-life for SAVI
7. Configure the lifetime period for SAVI bind-protect
8. Enable or disable SAVI prefix check function
9. Configure IPv6 address prefix for a link
10. Configure the filter entry number of IPv6 address
11. Configure the check mode for SAVI conflict binding
12. Enable or disable user authentication
13. Enable or disable DHCPv6 trust of port
14. Enable or disable ND trust of port
15. Configure the binding number

---

### 1. Enable or disable SAVI function

Command	Explanation
Global Mode	
<b>savi enable</b> <b>no savi enable</b>	Enable the global SAVI function, no command disables the function.

### 2. Enable or disable application scene function for SAVI

Command	Explanation
Global Mode	
<b>savi ipv6 {dhcp-only   slaac-only   dhcp-slaac} enable</b> <b>no savi ipv6 {dhcp-only   slaac-only   dhcp-slaac} enable</b>	Enable the application scene function for SAVI, no command disables the function.

### 3. Configure SAVI binding function

Command	Explanation
Global Mode	
<b>savi ipv6 check source binding ip &lt;ip-address&gt; mac &lt;mac-address&gt; interface &lt;if-name&gt; {type [slaac   dhcp] lifetime &lt;lifetime&gt;   type static}</b> <b>no savi ipv6 check source binding ip &lt;ip-address&gt; interface &lt;if-name&gt;</b>	Configure a static or dynamic binding manually, no command deletes the configured binding. This command may be configured in a global function of savi enable, slaac-only enable, dhcp-only enable or dhcp-slaac enable.

### 4. Configure the global max-dad-delay for SAVI

Command	Explanation
Global Mode	
<b>savi max-dad-delay &lt;max-dad-delay&gt;</b> <b>no savi max-dad-delay</b>	Configure the max lifetime period of SAVI binding at DETECTION state, no command restores the default value.

### 5. Configure the global max-dad-prepare-delay for SAVI

Command	Explanation
Global Mode	

<b>savi max-dad-prepare-delay</b> <b>&lt;max-dad-prepare-delay&gt;</b> <b>no savi max-dad-prepare-delay</b>	Configure the max redetection lifetime period for SAVI binding, no command restores the default value.
---	--

#### 6. Configure the global max-slaac-life for SAVI

Command	Explanation
Global Mode	
<b>savi max-slaac-life &lt;max-slaac-life&gt;</b> <b>no savi max-slaac-life</b>	Configure the lifetime period of the dynamic slaac binding at BOUND state, no command restores the default value.

#### 7. Configure the lifetime period for SAVI bind-protect

Command	Explanation
Global Mode	
<b>savi timeout bind-protect &lt;protect-time&gt;</b> <b>no savi timeout bind-protect</b>	Configure the bind-protect lifetime period to a port after its state from up to down, no command restores the default value.

#### 8. Enable or disable SAVI prefix check function

Command	Explanation
Global Mode	
<b>ipv6 cps prefix check enable</b> <b>no ipv6 cps prefix check enable</b>	Enable the address prefix check for SAVI, no command disables the function.

#### 9. Configure IPv6 address prefix for a link

Command	Explanation
Global Mode	
<b>ipv6 cps prefix &lt;ip-address&gt; vlan &lt;vid&gt;</b> <b>no ipv6 cps prefix &lt;ip-address&gt;</b>	Configure IPv6 address prefix for a link manually, no command deletes the configured address prefix.

#### 10. Configure the filter entry number of IPv6 address

Command	Explanation
Global Mode	

<b>savi ipv6 mac-binding-limit &lt;limit-num&gt;</b> <b>no savi ipv6 mac-binding-limit</b>	Configure the corresponding dynamic binding number for the same MAC address, no command restores the default value. Note: The binding number only limits the dynamic binding, but does not limit the static binding number.
---	---

#### 11. Configure the check mode for SAVI conflict binding

Command	Explanation
Global Mode	
<b>savi check binding &lt;simple / probe&gt; mode</b> <b>no savi check binding mode</b>	Configure the check mode for the conflict binding, no command deletes the check mode.

#### 12. Enable or disable user authentication

Command	Explanation
Port mode	
<b>savi ipv6 check source [ip-address mac-address   ip-address   mac-address]</b> <b>no savi ipv6 check source</b>	Enable the control authentication function for user, no command disables the function.

#### 13. Enable or disable DHCPv6 trust of port

Command	Explanation
Port mode	
<b>ipv6 dhcp snooping trust</b> <b>no ipv6 dhcp snooping trust</b>	Enable DHCPv6 trust port, no command disables the trust function. (port is translated from trust port into untrust port)

#### 14. Enable or disable ND trust of port

Command	Explanation
Port mode	
<b>ipv6 nd snooping trust</b> <b>no ipv6 nd snooping trust</b>	Configure a port as slaac trust and RA trust, no command deletes the port's trust function.



---

## 15. Configure the binding number

Command	Explanation
Port mode	
<b>savi ipv6 binding num &lt;limit-num&gt;</b> <b>no savi ipv6 binding num</b>	Configure the binding number of a port, no command restores the default value. Note: The binding number only limits the dynamic binding, but does not limit the static binding number.

## 62.3 SAVI Typical Application

In actual application, SAVI function is usually applied in access layer switch to check the validity of node source address on direct-link. There are four typical application scenes for SAVI function: DHCP-Only, Slaac-Only, DHCP-Slaac and Static binding. In network environment, users can select the corresponding scene according to the actual requirement; in double stacks network, while SAVI function associates with IPv4 DHCP snooping to use, IPv4 and IPv6 source address authentication is implemented.

Typical network topology application for SAVI function:

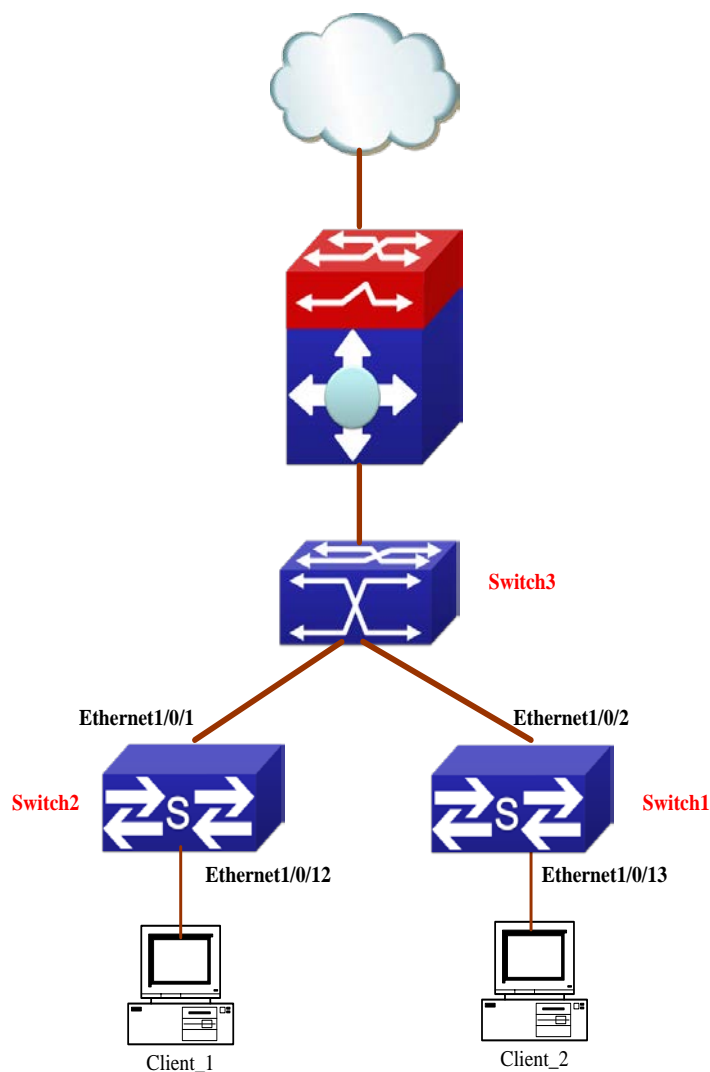

Client\_1 and Client\_2 means two different user's PC installed IPv6 protocol, respectively connect with port Ethernet1/0/12 of Switch1 and port Ethernet1/0/13 of Switch2, and enable the source address check function of SAVI. Ethernet1/0/1 and Ethernet1/0/2 are uplink ports of Switch1 and Switch2 respectively, enable DHCP trust and ND trust functions. Aggregation Switch3 enables DHCPv6 server function and route advertisement function.

Configuration steps of SAVI DHCP-SLAAC scene:

```
Switch1>enable
Switch1#config
Switch1(config)#savi enable
Switch1(config)#savi ipv6 dhcp-slaac enable
Switch1(config)#savi check binding probe mode
Switch1(config)#interface ethernet1/0/1
Switch1(config-if-ethernet1/0/1)#ipv6 dhcp snooping trust
Switch1(config-if-ethernet1/0/1)#ipv6 nd snooping trust
Switch1(config-if-ethernet1/0/1)#exit
Switch1(config)#interface ethernet1/0/12-20
Switch1(config-if-port-range)#savi ipv6 check source ip-address mac-address
```

```
Switch1(config-if-port-range)#savi ipv6 binding num 4
Switch1(config-if-port-range)#exit
Switch1(config)#exit
Switch1#write
```

## 62.4 SAVI Troubleshooting

After ensure no problem about SAVI client hardware and cable, please check the status which may exist and the propositional solutions in the following:

- If IPv6 packets are filtered incorrectly after enable SAVI function, please ensure the global SAVI function enabled. After that, enable the global function of the corresponding SAVI scene according to the actual application scene and enable the port authentication function.
- If client can not correctly obtain IPv6 address assigned by DHCPv6 server after enable SAVI function, please ensure DHCP port trust is configured by uplink port with DHCPv6 server.
- If node binding can not be set for the new user after enable SAVI function, please check whether the direct-link port configures the max binding number, and whether the binding number reaches to the max number. If the binding number exceeds the max binding limit, it is recommended to configure the bigger binding limit.
- If node binding can not be set for new user after configure the bigger binding limit, please check whether the direct-link port configures the corresponding binding number, and whether the corresponding binding number reaches to the max number in the same MAC address. If the binding number exceeds the max binding limit, it is recommended to configure the bigger binding limit.

---

# Chapter 63 Web Portal Configuration

## 63.1 Introduction to Web Portal Authentication

802.1x authentication uses the special client to authenticate, the device uses the special layer 2 switch, the authentication server uses RADIUS server, the format of authentication message uses EAP protocol. Use EAPOL encapsulation technique (encapsulate EAP packets within Ethernet frame) to process the communication between client and authentication proxy switch, but authentication proxy switch and authentication server use EAPOR encapsulation format (run EAP packets on Radius protocol) to process the communication. The device and RADIUS server use RADIUS protocol to transmit PAP packets or CHAP packets when the device processes to relay.

For implementing identity authentication and network accessing, user should install the special authentication client software, and spring the authentication flow to communicate with Radius server through logging in authentication client. The after 802.1x authentication adds web based authentication mode, the user can download a special Java Applet program by browser or other plug-in to replace 802.1x client.

For the environment which uses 802.1x authentication, installing client or downloading the special Java Applet program become a mortal problem. To satisfy user's actual requirement, the manual describes an application scene based on web portal authentication. Web portal authentication not only implements the basic device authentication without the client but also implement the security detection to the terminal.

## 63.2 Web Portal Authentication Configuration Task List

1. Enable/disable web portal authentication globally (required)
2. Enable/disable web portal authentication of the port (required)
3. Configure the max web portal binding number allowed by the port (optional)
4. Configure HTTP redirection address of web portal authentication (required)
5. Configure IP source address for communicating between accessing device and portal server (required)
6. Enable dhcp snooping binding web portal function (optional)
7. Delete the binding information of web portal authentication

### 1. Enable/disable web portal authentication globally

Command	Explanation
Global Mode	
<b>webportal enable</b> <b>no webportal enable</b>	Enable/disable web portal authentication globally.

---

## 2. Enable/disable web portal authentication of the port

Command	Explanation
Port Mode	
<b>webportal enable</b> <b>no webportal enable</b>	Enable/disable web portal authentication of the port.

## 3. Configure the max web portal binding number allowed by the port

Command	Explanation
Port Mode	
<b>webportal binding-limit &lt;1-256&gt;</b> <b>no webportal binding-limit</b>	Configure the max web portal binding number allowed by the port

## 4. Configure HTTP redirection address of web portal authentication

Command	Explanation
Global Mode	
<b>webportal redirect &lt;ip&gt;</b> <b>no webportal redirect</b>	Configure HTTP redirection address of web portal authentication.

## 5. Configure IP source address for communicating between accessing device and portal server

Command	Explanation
Global Mode	
<b>webportal nas-ip &lt;ip-address&gt;</b> <b>no webportal nas-ip</b>	Configure IP source address for communicating between accessing device and portal server.

## 6. Enable dhcp snooping binding web portal function

Command	Explanation
Global Mode	
<b>ip dhcp snooping binding webportal</b> <b>no ip dhcp snooping binding webportal</b>	Enable dhcp snooping binding web portal function.

## 7. Delete the binding information of web portal authentication

Command	Explanation
Admin Mode	

```
clear webportal binding {mac WORD |  
interface <ethernet IFNAME | IFNAME> |}
```

Delete the binding information of web portal authentication.

### 63.3 Web Portal Authentication Typical Example

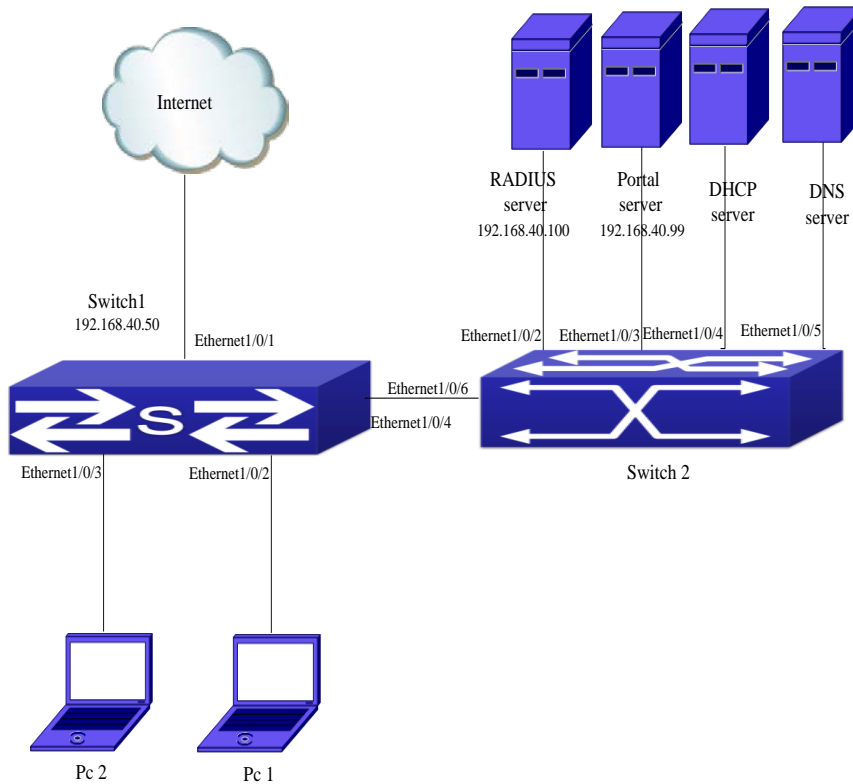

**Figure 63-1** Web portal typical application scene

In the above figure, pc1 is end-user, there is http browser in it, but no 802.1x authentication client, pc1 wants to access the network through web portal authentication.

Switch1 is the accessing device, it configures accounting server's address and port as RADIUS server's IP and port, and enable the accounting function. Ethernet 1/0/2 connects to pc1, the port enables web portal authentication, and configure the redirection address and port as portal server's IP and port, so ethernet 1/0/2 forbids all flows except dhcp/dns/arp packets.

Switch2 is the aggregation switch, ethernet1/0/2 connects to radius server, ethernet1/0/3 connects to portal server. The address of radius server is 192.168.40.100, the address of portal server is 192.168.40.99. ethernet1/0/4 connects to DHCP server, ethernet1/0/5 connects to DNS server. ethernet1/0/6 is trunk port and connects to ethernet1/0/4 of switch1.

---

The configuration of the common web portal authentication is as follows:

```
Switch(config)#interface vlan 1
Switch(config-if-vlan1)#ip address 192.168.40.50 255.255.255.0
Switch(config)#webportal enable
Switch(config)#webportal nas-ip 192.168.40.50
Switch(config)#webportal redirect 192.168.40.99
Switch(config)#interface ethernet 1/0/3
Switch(config-if-ethernet1/0/3)#webportal enable
```

Web portal authentication associates with DHCP snooping binding to use, the configuration is as follows:

```
Switch(config)#ip dhcp snooping enable
Switch(config)#ip dhcp snooping binding enable
Switch(config)#interface ethernet 1/0/2
Switch(config-if-ethernet1/0/2)#webportal enable
Switch(config-if-ethernet1/0/2)#ip dhcp snooping binding webportal
```

## 63.4 Web Portal Authentication Troubleshooting

When using web portal authentication, the system will show the detailed prompt information if the operation is wrong. Web portal authentication is disabled by default. After ensuring the configuration is correct, use debug command and show command to check the related information if you cannot determine the cause of the problem. Please send the recorded message to our technical service center.

---

# Chapter 64 VRRP Configuration

## 64.1 Introduction to VRRP

VRRP (Virtual Router Redundancy Protocol) is a fault tolerant protocol designed to enhance connection reliability between routers (or L3 Ethernet switches) and external devices. It is developed by the IETF for local area networks (LAN) with multicast/broadcast capability (Ethernet is a Configuration Example) and has wide applications.

All hosts in one LAN generally have a default route configured to specified default gateway, any packet destined to an address outside the native segment will be sent to the default gateway via this default route. These hosts in the LAN can communicate with the external networks. However, if the communication link connecting the router serving as default gateway and external networks fails, all hosts using that gateway as the default next hop route will be unable to communicate with the external networks.

VRRP emerged to resolve such problem. VRRP runs on multiple routers in a LAN, simulating a "virtual" router (also referred to as a "Standby cluster") with the multiple routes. There is an active router (the "Master") and one or more backup routers (the "Backup") in the Standby cluster. The workload of the virtual router is actually undertaken by the active router, while the Backup routers serve as backups for the active router.

The virtual router has its own "virtual" IP address (can be identical with the IP address of some router in the Standby cluster), and routers in the Standby cluster also have their own IP address. Since VRRP runs on routers or Ethernet Switches only, the Standby cluster is transparent to the hosts with the segment. To them, there exists only the IP address of the Virtual Router instead of the actual IP addresses of the Master and Backup(s). And the default gateway setting of all the hosts uses the IP address of the Virtual Router. Therefore, hosts within the LAN communicate with the other networks via this Virtual Router. But basically, they are communicating with the other networks via the Master. In the case when the Master of the Standby cluster fails, a backup will take over its task and become the Master to serve all the hosts in the LAN, so that uninterrupted communication between LAN hosts and external networks can be achieved.

To sum it up, in a VRRP Standby cluster, there is always a router/Ethernet serving as the active router (Master), while the rest of the Standby cluster servers act as the backup router(s) (Backup, can be multiple) and monitor the activity of Master all the time. Should the Master fail, a new Master will be elected by all the Backups to take over the work and continue serving the hosts within the segment. Since the election and take-over duration is brief and smooth, hosts within the segment can use the Virtual Router as normal and uninterrupted communication can be achieved.



---

## 64.2 VRRP Configuration Task List

Configuration Task List:

1. Create/Remove the Virtual Router (required)
2. Configure VRRP dummy IP and interface (required)
3. Activate/Deactivate Virtual Router (required)
4. Configure VRRP sub-parameters (optional)
  - (1) Configure the preemptive mode for VRRP
  - (2) Configure VRRP priority
  - (3) Configure VRRP Timer intervals
  - (4) Configure VRRP interface monitor

### 1. Create/Remove the Virtual Router

Command	Explanation
Global Mode	
<b>router vrrp &lt;vrid&gt;</b> <b>no router vrrp &lt;vrid&gt;</b>	Creates/Removes the Virtual Router.

### 2. Configure VRRP Dummy IP Address and Interface

Command	Explanation
VRRP protocol configuration mode	
<b>virtual-ip &lt;ip&gt;</b> <b>no virtual-ip</b>	Configures VRRP Dummy IP address; the " <b>no virtual-ip</b> " command removes the virtual IP address.
<b>interface {IFNAME   Vlan &lt;ID&gt;}</b> <b>no interface</b>	Configures VRRP interface, the " <b>no interface</b> " command removes the interface.

### 3. Activate/Deactivate Virtual Router

Command	Explanation
VRRP protocol configuration mode	
<b>enable</b>	Activates the Virtual Router.
<b>disable</b>	Deactivates the Virtual Router.

### 4. Configure VRRP Sub-parameters

- (1) Configure the preemptive mode for VRRP

Command	Explanation
VRRP protocol configuration mode	
<b>preempt-mode {true  false}</b>	Configures the preemptive mode for VRRP.

(2) Configure VRRP priority

Command	Explanation
VRRP protocol configuration mode	
<b>priority &lt;priority&gt;</b>	Configures VRRP priority.

(3) Configure VRRP Timer intervals

Command	Explanation
VRRP protocol configuration mode	
<b>advertisement-interval &lt;time&gt;</b>	Configures VRRP timer value (in seconds).

(4) Configure VRRP interface monitor

Command	Explanation
VRRP protocol configuration mode	
<b>circuit-failover {IFNAME   Vlan &lt;ID&gt; } &lt;value_reduced&gt; no circuit-failover</b>	Configures VRRP interface monitor, the " <b>no circuit-failover</b> " removes monitor to the interface.

## 64.3 VRRP Typical Examples

As shown in the figure below, SwitchA and SwitchB are Layer three Ethernet Switches in the same group and provide redundancy for each other.

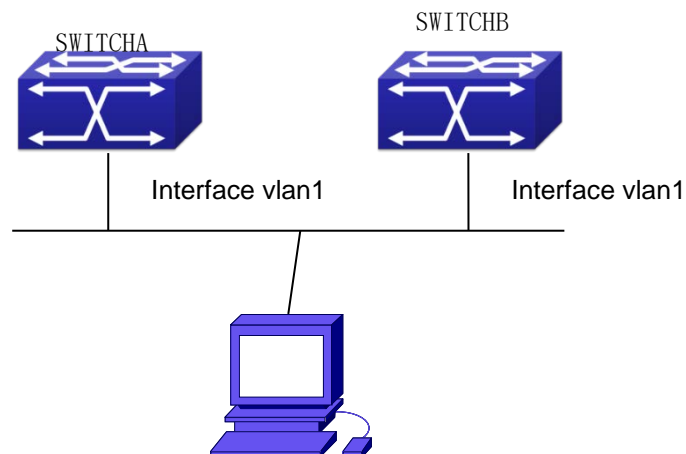

Figure 64-1 VRRP Network Topology

Configuration of SwitchA:

```
SwitchA(config)#interface vlan 1
SwitchA (Config-if-Vlan1)# ip address 10.1.1.1 255.255.255.0
SwitchA (config)#router vrrp 1
```

```
SwitchA(Config-Router-Vrrp)# virtual-ip 10.1.1.5
SwitchA(Config-Router-Vrrp)# interface vlan 1
SwitchA(Config-Router-Vrrp)# enable
```

Configuration of SwitchB:

```
SwitchB(config)#interface vlan 1
SwitchB (Config-if-Vlan1)# ip address 10.1.1.7 255.255.255.0
SwitchB(config)#router vrrp 1
SwitchB (Config-Router-Vrrp)# virtual-ip 10.1.1.5
SwitchB(Config-Router-Vrrp)# interface vlan 1
SwitchB(Config-Router-Vrrp)# enable
```

## 64.4 VRRP Troubleshooting

In configuring and using VRRP protocol, the VRRP protocol may fail to run properly due to reasons such as physical connection failure or wrong configurations. The user should ensure the following:

- Good condition of the physical connection.
- All interface and link protocols are in the UP state (use “**show interface**” command).
- Ensure VRRP is enabled on the interface. Verify the authentication mode of different routers (or L3 Ethernet switches) in the same standby cluster are the same.
- Verify the timer time of different routers (or L3 Ethernet switches) in the same standby cluster are the same.
- Verify the dummy IP address is in the same network segment of the interface’s actual IP address.
- If the examination remains unsolved, please use **debug vrrp** and other debugging command and copy the DEBUG message within 3 minutes, send the recorded message to the technical server center of our company.

---

# Chapter 65 IPv6 VRRPv3 Configuration

## 65.1 Introduction to VRRPv3

VRRPv3 is a virtual router redundancy protocol for IPv6. It is designed based on VRRP (VRRPv2) in IPv4 environment. The following is a brief introduction to it.

In a network based on TCP/IP protocol, in order to guarantee the communication between the devices which are not physically connected, routers should be specified. At present there are two most commonly used methods to specify routers: one is to study dynamically via routing protocols (such as internal routing protocols RIP and OSPF); the other is to configure statically. Running dynamical routing protocol on each terminal is unrealistic, since most operating systems for client end do not support dynamical routing protocol, even if they do, they are limited by the overheads of management, convergence, security and many other problems. So the common method is to adopt static routing configuration on terminal IP devices, which usually means specify one or more default gateway for terminal devices. Static routing simplifies the management of network and reduces the communication overheads of terminal devices, but it still has a disadvantage: if the router acting as the default gateway breaks, the communication of all the hosts which use this gateway as their next hop host. Even if there are more than one default gateways, before rebooting the terminal devices, they can not switch to the new gateway. Adopting virtual router redundancy protocol (VRPR) can effectively avoid the flaws of statically specifying gateways.

In VRRP protocol, there are two groups of import concepts: VRRP routers and virtual routers, master routers and backup routers. VRRP routers are routers running VRRP, which are physical entities; virtual routers are the ones created by VRRP, which are logical concepts. A group of VRRP routers cooperate to comprise a virtual router, which acts outwardly as a logical router with a unique fixed IP address and MAC address. The routers belonging to the same VRRP group play two mutually exclusive roles at the same time: master routers and backup routers. One VRRP group can only have one master router other but one or more backup routers. VRRPv3 protocol uses selection policy to select a master router from the router group to take charge of responding ND(Neighbor Discovery) neighbor request messages(ARP in IPv4) and forwarding IP data packets, while the other routers in the group will be in a state of waiting as backups. When the master router has a problem for some season, the backup router will be updated to the master router after a delay of a few seconds. Since this switch is very fast and does not need to change IP address or MAC address, it will be transparent to terminal user systems.

In IPv6 environment, the hosts in a LAN usually learn the default gateway via neighbor discovery protocol (NDP), which is implemented based on regularly receiving advertisement messages from routers. The NDP of IPv6 has a mechanism called Neighbor Unreachability Detection, which checks whether a neighbor node is failed by sending unicast neighbor request messages to it. In order to reduce the overheads of sending neighbor request messages, these messages are only sent to those neighbor nodes which are sending flows, and are only sent if there is no instruction of UP state of the router in a period of time. In Neighbor Unreachability Detection, if adopting default parameters, it will take about 38 seconds to detect an unreachable router, which is a delay not ignorable for users and might cause a time-out in some transport

protocols. Compared with NDP, VRRP provides a fast default gateway switch. In VRRP, backup routers can take up the unavailable master router in about 3 seconds (default parameter), and this process needs no interaction with hosts, which means being transparent to hosts.

### 65.1.1 The Format of VRRPv3 Message

VRRPv3 has its own message format, VRRP messages are used to communicate the priority of routers and the state of Master in the backup group, they are encapsulated in IPv6 messages to send, and are sent to the specified IPv6 multicast address. The format of VRRPv3 message is shown in Graph 1. The source address of the IPv6 message encapsulating the VRRPv3 message is the local address of the outbound interface of the message, and the destination address of it is the IPv6 multicast address(the multicast allocated to VRRPv3 is FF02:0:0:0:0:0:0:12). The number of hops should be limited to 255, and the next message head is 112(representing a VRRP message).

The meaning of each field in a VRRPv3 message is shown as follows:

Version: The version of VRRPv3, whose value is 3;

Type: The type of VRRP messages. There is only one type: ADVERTISEMENT, and its value is 1;

Virtual Rtr ID : The ID of the virtual router;

Priority : Priority, ranging from 0 to 255;

Count IPv6 Addr : The number of IPv6 addresses in a VRRPv3 message, the minimum of which is 1;

Rsvd : Reserved field, whose value is 0;

Adver Int : The advertisement interval of VRRPv3 messages, in seconds;

Checksum : The checksum, taking account of the whole VRRPv3 message and an IPv6 pseudo head (please refer to RFC2460 for details);

IPv6 Address(es) : one or more IPv6 addresses related to the virtual router, the number of which is the same with "Count IPv6 Addr", and the first one of which should be the virtual IPv6 address of the virtual router.

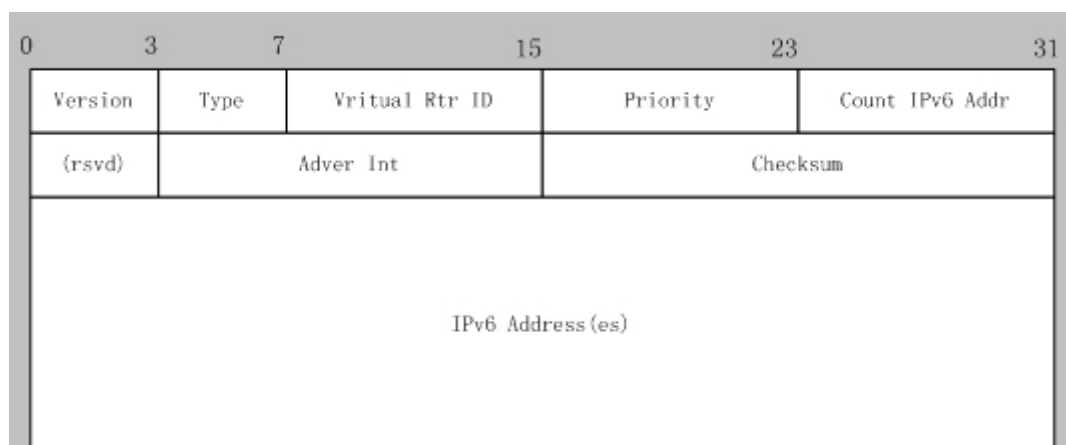

Figure 65-1 VRRPv3 message

---

## 65.1.2 VRRPv3 Working Mechanism

The working mechanism of VRRPv3 is the same with that of VRRPv2, which is mainly implemented via the interaction of VRRP advertisement messages. It will be briefly described as follows:

Each VRRP router has a unique ID: VRID, ranging from 1 to 255. This router has a unique virtual MAC address outwardly, and the format of which is 00-00-5E-00-02-`{VRID}` (the format of virtual MAC address in VRRPv2 is 00-00-5E-00-01-`{VRID}`). Master router is in charge of using this MAC address to respond to ND neighbor request (it is ARP request in VRRPv2). Thus, no matter what switch is made, the terminal devices will get the same IP and MAC address all the time, reducing the affection that the switch causes on terminal devices.

There is only one kind of VRRP control message: VRRP advertisement. It uses IP multicast data packets to encapsulate, and the format of multicast addresses is FF02:0:0:0:0:XXXX:XXXX. In order to keep a consistence with the multicast address in VRRPv2 (224.0.0.18), the multicast addresses used by VRRPv3 advertisement messages can be FF02:0:0:0:0:0:12, and the advertisement is limited within the same LAN. Thus, different VRID are guaranteed to be used repeatedly in different networks. In order to reduce the overheads of network bandwidth, only master routers can send VRRP advertisement messages regularly. Backup routers will start a new round of VRRP selection if it hasn't received a VRRP advertisement in 3 advertisement intervals in a row or if it receives an advertisement with a priority of 0.

In a VRRP router group, the master router is selected according to priority. The range of priority in VRRP protocol is 0-255. If the IP address of a VRRP router is the same to that of the virtual router interface, then the virtual router will be called the IP address owner in the VRRP group; the IP address owner automatically has the highest priority: 255. The priority of 0 is usually used when the IP address owner gives up the role of master. The range of priority can be configured is 1-254. The configuration rule of priority can be set according to the speed and cost of the link, the performance and reliability of the router and other management policies. In the selection of the master router, the virtual router with high priority will win. So, if there is an IP owner in the VRRP group, it will always be the master router. For the candidate routers having the same priority, selection will be done according to the magnitude of IP addresses (the bigger IP address takes precedence). VRRP also provides a preemptive priority policy. If such policy is configured, the backup router with higher priority will preempt the role of new master router over the current master router with lower priority.

In order to avoid the fault of returning a physical MAC address when Pinging virtual IP, it is regulated that virtual IP can not be the real IP of the interface. Thus, all the interfaces participating of the backup group selection will be backup by default.

---

## 65.2 VRRPv3 Configuration

### 65.2.1 Configuration Task Sequence

1. Create/delete the virtual router (necessary)
2. Configure the virtual IPv6 address and interface of VRRPv3 (necessary)
3. Enable/disable the virtual router (necessary)
4. Configure VRRPv3 assistant parameters (optional)
  - (1) Configure VRRPv3 preempt mode
  - (2) Configure VRRPv3 priority
  - (3) Configure the VRRPv3 advertisement interval
  - (4) Configure the monitor interface of VRRPv3

#### 1. Create/delete the virtual router

Command	Explanation
Global Configuration Mode	
<b>router ipv6 vrrp &lt;vrid&gt;</b> <b>no router ipv6 vrrp &lt;vrid&gt;</b>	Create/delete the virtual router.

#### 2. Configure the virtual IPv6 address and interface of VRRPv3

Command	Explanation
VRRPv3 Protocol Mode	
<b>virtual-ipv6 &lt;ipv6-address&gt; Interface</b> <b>{Vlan &lt;ID&gt;   IFNAME }</b> <b>no virtual-ipv6 interface</b>	Configure the virtual IPv6 address and interface of VRRPv3, the no operation of this command will delete the virtual IPv6 address and interface.

#### 3. Enable/disable the virtual router

Command	Explanation
VRRPv3 Protocol Mode	
<b>enable</b>	Enable the virtual router.
<b>disable</b>	Disable the virtual router.

#### 4. Configure VRRPv3 assistant parameters

- (1) Configure VRRPv3 preempt mode

Command	Explanation
VRRPv3 Protocol Mode	
<b>preempt-mode {true  false}</b>	Configure VRRPv3 preempt mode.

( 2 ) Configure VRRPv3 priority

Command	Explanation
VRRPv3 Protocol Mode	
<b>priority &lt; priority &gt;</b>	Configure VRRPv3 priority.

( 3 ) Configure the VRRPv3 advertisement interval

Command	Explanation
VRRPv3 Protocol Mode	
<b>advertisement-interval &lt;time&gt;</b>	Configure the VRRPv3 advertisement interval (in cent seconds).

( 4 ) Configure the monitor interface of VRRPv3

Command	Explanation
VRRPv3 Protocol Mode	
<b>circuit-failover {vlan &lt;ID&gt;  IFNAME} &lt;value_reduced&gt;</b> <b>no circuit-failover</b>	Configure the monitor interface of VRRPv3, the no operation of this command will delete the monitor interface.

## 65.3 VRRPv3 Typical Examples

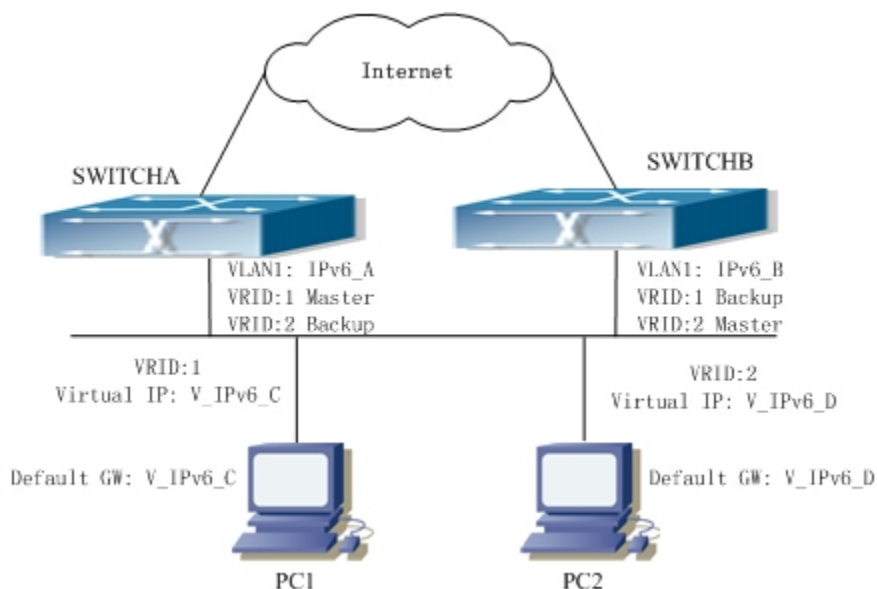

Figure 65-2 VRRPv3 Typical Network Topology

As shown in graph, switch A and switch B are backups to each other, switch A is the master of backup group 1 and a backup of backup group 2. Switch B is the master of backup group 2 and a Backup of backup group 1. The IPv6 addresses of switch A and switch B are "IPv6\_A" and "IPv6\_B" respectively (it is recommended that



---

IPv6\_A and IPv6\_B are in the same segment), the virtual IPv6 address of backup group 1 and backup group are “V\_IPv6\_C” and “V\_IPv6\_D” respectively, and the default IPv6 gateway address are configured as “V\_IPv6\_C” and “V\_IPv6\_D” respectively (in reality, the IPv6 gateway address of hosts are usually learnt automatically via router advertisements, thus, the IPv6 next hop of the hosts will have some randomness). Doing this will not only implement router backup but also the flow sharing function in the LAN.

The configuration of SwitchA:

```
SwitchA (config)#ipv6 enable
SwitchA (config)#interface vlan 1
SwitchA (config)#router ipv6 vrrp 1
SwitchA (config-router)#virtual-ipv6 fe80::2 interface vlan 1
SwitchA (config-router)#priority 150
SwitchA (config-router)#enable
SwitchA (config)#router ipv6 vrrp 2
SwitchA (config-router)#virtual-ipv6 fe80::3 interface vlan 1
SwitchA (config-router)#enable
```

The configuration of SwitchB:

```
SwitchB (config)# ipv6 enable
SwitchB (config)# interface vlan 1
SwitchB (config)# router ipv6 vrrp 2
SwitchB (config-router)# virtual-ipv6 fe80::3 interface vlan 1
SwitchB (config-router)# priority 150
SwitchB (config-router)# enable
SwitchB (config)# router ipv6 vrrp 1
SwitchB (config-router)# virtual-ipv6 fe80::2 interface vlan 1
SwitchB (config-router)# enable
```

## 65.4 VRRPv3 Troubleshooting

When configuring and using VRRPv3 protocol, it might operate abnormally because of incorrect physical connections and configuration. So, users should pay attention to the following points:

- First, the physical connections should be correct;
- Next, the interface and link protocol are UP (use **show ipv6 interface** command);
- And then, make sure that IPv6 forwarding function is enabled (use **ipv6 enable** command);
- Besides, make sure that VRRPv3 protocol is enable on the interface;
- Check whether the time of timer in different routers (or layer-three Ethernet switch) within the same backup group is the same;
- Check whether the virtual IPv6 addresses in the same backup group is the same.

---

# Chapter 66 MRPP Configuration

## 66.1 Introduction to MRPP

MRPP (Multi-layer Ring Protection Protocol), is a link layer protocol applied on Ethernet loop protection. It can avoid broadcast storm caused by data loop on Ethernet ring, and restore communication among every node on ring network when the Ethernet ring has a break link. MRPP is the expansion of EAPS (Ethernet link automatic protection protocol).

MRPP protocol is similar to STP protocol on function, MRPP has below characters, compare to STP protocol:

- <1> MRPP specifically uses to Ethernet ring topology
- <2> fast convergence, less than 1 s. ideally it can reach 100-50 ms.

### 66.1.1 Conception Introduction

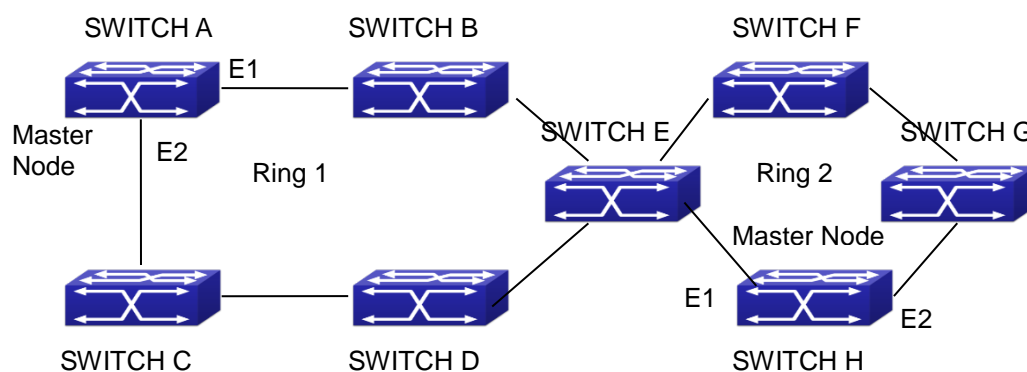

Figure 66-1 MRPP Sketch Map

#### 1. Control VLAN

Control VLAN is a virtual VLAN, only used to identify MRPP protocol packet transferred in the link. To avoid confusion with other configured VLAN, avoids configuring control VLAN ID to be the same with other configured VLAN ID. The different MRPP ring should configure the different control VLAN ID.

#### 2. Ethernet Ring (MRPP Ring)

Ring linked Ethernet network topology.

Each MRPP ring has two states.

Health state: The whole ring network physical link is connected.

Break state: one or a few physical link break in ring network

---

### 3. nodes

Each switch is named after a node on Ethernet. The node has some types:

Primary node: each ring has a primary node, it is main node to detect and defend.

Transfer node: except for primary node, other nodes are transfer nodes on each ring.

The node role is determined by user configuration. As shown above, Switch A is primary node of Ring 1, Switch B. Switch C; Switch D and Switch E are transfer nodes of Ring 1.

### 4. Primary port and secondary port

The primary node and transfer node have two ports connecting to Ethernet separately, one is primary port, and another is secondary port. The role of port is determined by user configuration.

Primary port and secondary port of primary node

The primary port of primary node is used to send ring health examine packet (hello), the secondary port is used to receive Hello packet sending from primary node. When the Ethernet is in health state, the secondary port of primary node blocks other data in logical and only MRPP packet can pass. When the Ethernet is in break state, the secondary port of primary node releases block state, and forwards data packets.

There are no difference on function between Primary port and secondary port of transfer node.

The role of port is determined by user configuration. As shown in above, Switch A E1 is primary port, E2 is secondary port.

### 5. Timer

The two timers are used when the primary node sends and receives MRPP protocol packet: Hello timer and Fail Timer.

Hello timer: define timer of time interval of health examine packet sending by primary node primary port.

Fail timer: define timer of overtime interval of health examine packet receiving by primary node primary port.

The value of Fail timer must be more than or equal to the 3 times of value of Hello timer.

## 66.1.2 MRPP Protocol Packet Types

Packet Type	Explanation
Hello packet (Health examine packet) Hello	The primary port of primary node evokes to detect ring, if the secondary port of primary node can receive Hello packet in configured overtime, so the ring is normal.
LINK-DOWN (link Down event packet)	After transfer node detects Down event on port, immediately sends LINK-DOWN packet to primary node, and inform primary node ring to fail.
LINK-DOWN-FLUSH_FDB packet	After primary node detects ring failure or receives LINK-DOWN packet, open blocked secondary port, and then uses two ports to send the packet, to inform each transfer node to refresh own MAC address.
LINK-UP-FLUSH_FDB packet	After primary detects ring failure to restore normal, and uses packet from primary port, and informs each transfer node to refresh own MAC address.

---

## 66.1.3 MRPP Protocol Operation System

### 1. Link Down Alarm System

When transfer node finds themselves belonging to MRPP ring port Down, it sends link Down packet to primary node immediately. The primary node receives link down packet and immediately releases block state of secondary port, and sends LINK-DOWN-FLUSH-FDB packet to inform all of transfer nodes, refreshing own MAC address forward list.

### 2. Poll System

The primary port of primary node sends Hello packet to its neighbors timely according to configured Hello-timer.

If the ring is health, the secondary port of primary node receives health detect packet, and the primary node keeps secondary port.

If the ring is break, the secondary port of primary node can't receive health detect packet when timer is over time. The primary releases the secondary port block state, and sends LINK-DOWN-FLUSH\_FDB packet to inform all of transfer nodes, to refresh own MAC address forward list.

### 3. Ring Restore

After the primary node occur ring fail, if the secondary port receives Hello packet sending from primary node, the ring has been restored, at the same time the primary node block its secondary port, and sends its neighbor LINK-UP-Flush-FDB packet.

After MRPP ring port refresh UP on transfer node, the primary node maybe find ring restore after a while. For the normal data VLAN, the network maybe forms a temporary ring and creates broadcast storm. To avoid temporary ring, transfer node finds it to connect to ring network port to refresh UP, immediately block temporarily (only permit control VLAN packet pass), after only receiving LINK-UP-FLUSH-FDB packet from primary node, and releases the port block state.

## 66.2 MRPP Configuration Task List

- 1) Globally enable MRPP
- 2) Configure MRPP ring
- 3) Configure the query time of MRPP
- 4) Display and debug MRPP relevant information

### 1) Globally enable MRPP

Command	Explanation
Global Mode	
<b>mrpp enable</b> <b>no mrpp enable</b>	Globally enable and disable MRPP.

2) Configure MRPP ring

Command	Explanation
Global Mode	
<b>mrpp ring &lt;ring-id&gt;</b> <b>no mrpp ring &lt;ring-id&gt;</b>	Create MRPP ring. The “no” command deletes MRPP ring and its configuration.
MRPP ring mode	
<b>control-vlan &lt;vid&gt;</b> <b>no control-vlan</b>	Configure control VLAN ID, format “no” deletes configured control VLAN ID.
<b>node-mode {master   transit}</b>	Configure node type of MRPP ring (primary node or secondary node).
<b>hello-timer &lt; timer&gt;</b> <b>no hello-timer</b>	Configure Hello packet timer sending from primary node of MRPP ring, format “no” restores default timer value.
<b>fail-timer &lt;timer&gt;</b> <b>no fail-timer</b>	Configure Hello packet overtime timer sending from primary node of MRPP ring, format “no” restores default timer value.
<b>enable</b> <b>no enable</b>	Enable MRPP ring, format “no” disables enabled MRPP ring.
Port mode	
<b>mrpp ring &lt;ring-id&gt; primary-port</b> <b>no mrpp ring &lt;ring-id&gt; primary-port</b>	Specify primary port of MRPP ring.
<b>mrpp ring &lt;ring-id&gt; secondary-port</b> <b>no mrpp ring &lt;ring-id&gt; secondary-port</b>	Specify secondary port of MRPP ring.

3) Configure the query time of MRPP

Command	Explanation
Global Mode	
<b>mrpp poll-time &lt;20-2000&gt;</b>	Configure the query interval of MRPP.

4) Display and debug MRPP relevant information

Command	Explanation
Admin Mode	
<b>debug mrpp</b> <b>no debug mrpp</b>	Disable MRPP module debug information, format “no” disable MRPP debug information output.
<b>show mrpp {&lt;ring-id&gt;}</b>	Display MRPP ring configuration information.
<b>show mrpp statistics {&lt;ring-id&gt;}</b>	Display receiving data packet statistic information of MRPP ring.

```
clear mrpp statistics {<ring-id>}
```

Clear receiving data packet statistic information of MRPP ring.

## 66.3 MRPP Typical Scenario

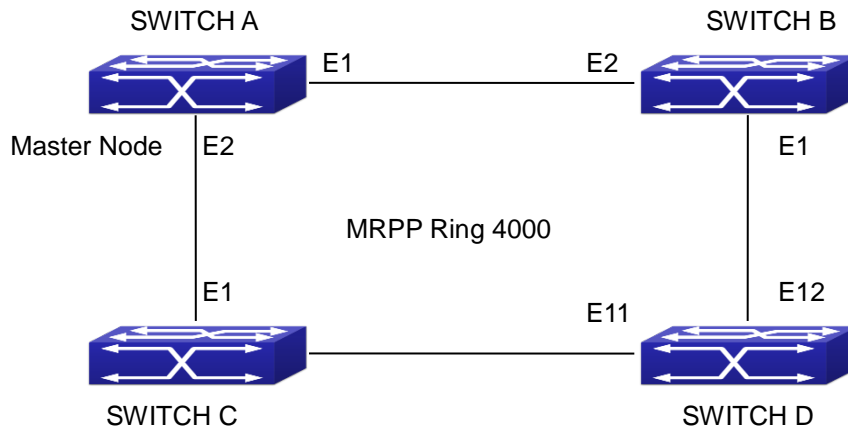

Figure 66-2 MRPP typical configuration scenario

The above topology often occurs on using MRPP protocol. The multi switch constitutes a single MRPP ring, all of the switches only are configured an MRPP ring 4000, thereby constitutes a single MRPP ring.

In above configuration, SWITCH A configuration is primary node of MRPP ring 4000, and configures E1/0/1 to primary port, E1/0/2 to secondary port. Other switches are secondary nodes of MRPP ring, configures primary port and secondary port separately.

To avoid ring, it should temporarily disable one of the ports of primary node, when it enables each MRPP ring in the whole MRPP ring; and after all of the nodes are configured, open the port.

When disable MRPP ring, it needs to insure the MRPP ring doesn't have ring.

SWITCH A configuration Task Sequence:

```
Switch(Config)#mrpp enable
Switch(Config)#mrpp ring 4000
Switch(mrpp-ring-4000)#control-vlan 4000
Switch(mrpp-ring-4000)#fail-timer 18
Switch(mrpp-ring-4000)#hello-timer 5
Switch(mrpp-ring-4000)#node-mode master
Switch(mrpp-ring-4000)#enable
Switch(mrpp-ring-4000)#exit
Switch(Config)#interface ethernet 1/0/1
Switch(config-If-Ethernet1/0/1)#mrpp ring 4000 primary-port
Switch(config-If-Ethernet1/0/1)#interface ethernet 1/0/2
Switch(config-If-Ethernet1/0/2)#mrpp ring 4000 secondary-port
Switch(config-If-Ethernet1/0/2)#exit
```

```
Switch(Config)#
```

SWITCH B configuration Task Sequence:

```
Switch(Config)#mrpp enable
Switch(Config)#mrpp ring 4000
Switch(mrpp-ring-4000)#control-vlan 4000
Switch(mrpp-ring-4000)#enable
Switch(mrpp-ring-4000)#exit
Switch(Config)#interface ethernet 1/0/1
Switch(config-If-Ethernet1/0/1)#mrpp ring 4000 primary-port
Switch(config-If-Ethernet1/0/1)#interface ethernet 1/0/2
Switch(config-If-Ethernet1/0/2)#mrpp ring 4000 secondary-port
Switch(config-If-Ethernet1/0/2)#exit
Switch(Config)#
```

SWITCH C configuration Task Sequence:

```
Switch(Config)#mrpp enable
Switch(Config)#mrpp ring 4000
Switch(mrpp-ring-4000)#control-vlan 4000
Switch(mrpp-ring-4000)#enable
Switch(mrpp-ring-4000)#exit
Switch(Config)#interface ethernet 1/0/1
Switch(config-If-Ethernet1/0/1)#mrpp ring 4000 primary-port
Switch(config-If-Ethernet1/0/1)#interface ethernet 1/0/2
Switch(config-If-Ethernet1/0/2)#mrpp ring 4000 secondary-port
Switch(config-If-Ethernet1/0/2)#exit
Switch(Config)#
```

SWITCH D configuration Task Sequence:

```
Switch(Config)#mrpp enable
Switch(Config)#mrpp ring 4000
Switch(mrpp-ring-4000)#control-vlan 4000
Switch(mrpp-ring-4000)#enable
Switch(mrpp-ring-4000)#exit
Switch(Config)#interface ethernet 1/0/1
Switch(config-If-Ethernet1/0/1)#mrpp ring 4000 primary-port
Switch(config-If-Ethernet1/0/1)#interface ethernet 1/0/2
Switch(config-If-Ethernet1/0/2)#mrpp ring 4000 secondary-port
Switch(config-If-Ethernet1/0/2)#exit
Switch(Config)#
```

---

## 66.4 MRPP Troubleshooting

The normal operation of MRPP protocol depends on normal configuration of each switch on MRPP ring, otherwise it is very possible to form ring and broadcast storm:

- Configuring MRPP ring, you'd better disconnected the ring, and wait for each switch configuration, then open the ring.
- When the MRPP ring of enabled switch is disabled on MRPP ring, it ensures the ring of the MRPP ring has been disconnected.
- When there is broadcast storm on MRPP ring, it disconnects the ring firstly, and ensures if each switch MRPP ring configuration on the ring is correct or not; if correct, restores the ring, and then observes the ring is normal or not.
- The convergence time of MRPP ring net is relative to the response mode of up/down. If use poll mode, the convergence time as hundreds of milliseconds in simple ring net, if use interrupt mode, the convergence time within 50 milliseconds.
- Generally, the port is configured as poll mode, interrupt mode is only applied to better performance environment, but the security of poll mode is better than interrupt mode, port-scan-mode {interrupt | poll} command can be consulted.
- In normal configuration, it still forms ring broadcast storm or ring block, please open debug function of primary node MRPP, and used show MRPP statistics command to observe states of primary node and transfer node and statistics information is normal or not, and then sends results to our Technology Service Center.



# Chapter 67 ULPP Configuration

## 67.1 Introduction to ULPP

Each ULPP group has two uplink ports, they are master port and slave port. The port may be a physical port or a port channel. The member ports of ULPP group have three states: Forwarding, Standby, Down. Normally, only one port at the forwarding state, the other port is blocked at the Standby state. When the master port has the link problem, the master port becomes down state, and the slave port is switched to forwarding state.

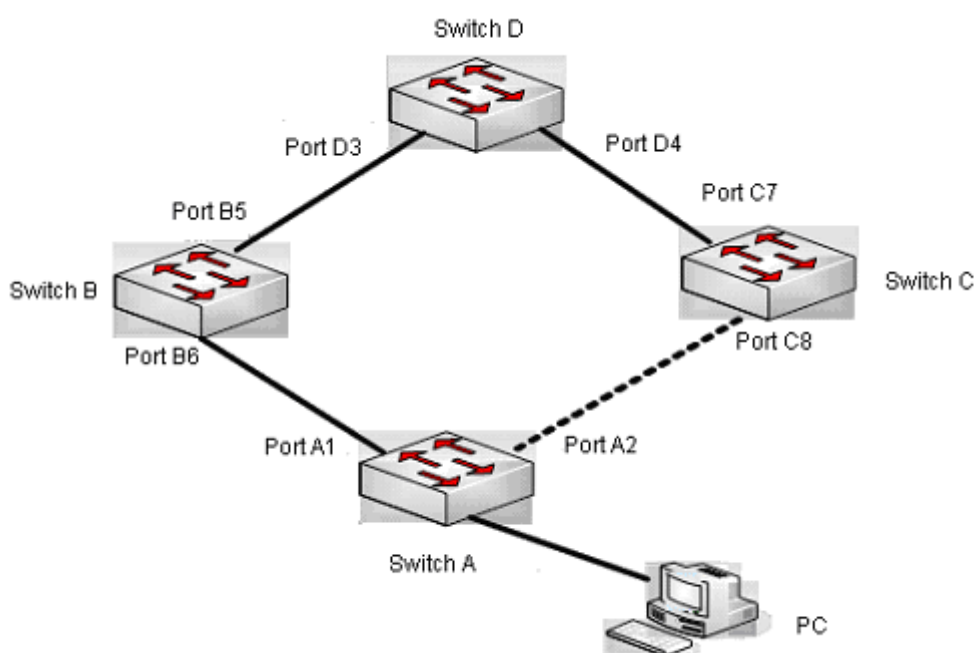

**Figure 67-1** the using scene of ULPP

The above figure uses the double-uplink network, this is the typical application scene of ULPP. SwitchA goes up to SwitchD through SwitchB and SwitchC, port A1 and port A2 are the uplink ports. SwitchA configures ULPP, there into port A1 is set as the master port, port A2 is set as the slave port. When port A1 at forwarding state has the problem, switch the uplink at once, port A2 turns into forwarding state. After this, when recovering the master port, if the preemption mode is not configured, port A2 keeps the Forwarding state, port A1 turns into the Standby state.

After the preemption mode is enabled, so as to the master port preempts the slave port when it recovered from the problem. For avoiding the frequent uplink switch caused by the abnormality problem, the preemption delay mechanism is imported, and it needs to wait for some times before the master port preempt the slave port. For keeping the continuance of the flows, the master port does not process to preempt by default, but turns into the Standby state.

When configuring ULPP, it needs to specify the VLAN which is protected by this ULPP group through the

method of MSTP instances, and ULPP does not provide the protection to other VLANs.

When the uplink switch is happening, the primary forwarding entries of the device will not be applied to new topology in the network. In the figure, SwitchA configures ULPP, the portA1 as the master port at forwarding state, here the MAC address of PC is learned by Switch D from portD3. After this, portA1 has the problem, the traffic is switched to portA2 to be forwarded. If there is the data sent to PC by SwitchD, still the data will be forwarded from portD3, and will be lost. Therefore, when switching the uplink, the device of configuring ULPP needs to send the flush packets through the port which is switched to Forwarding state, and update MAC address tables and ARP tables of other devices in the network. ULPP respectively uses two kinds of flush packets to update the entries: the updated packets of MAC address and the deleted packets of ARP.

For making use of the bandwidth resource enough, ULPP can implement VLAN load balance through the configuration. As the picture illustrated, SwitchA configures two ULPP groups: portA1 is the master port and portA2 is the slave port in group1, portA2 is the master port and portA1 is the slave port in group2, the VLANs are protected by group1 and group2, they are 1-100 and 101-200. Here both portA1 and portA2 at the forwarding state, the master port and the slave port mutually backup, and respectively forward the packets of the different VLAN ranges. When portA1 has the problem, the traffic of VLAN 1-200 are forwarded by portA2. After this, when portA1 is recovering the normal state, portA2 forwards the data of VLAN 101-200 sequentially, but the data of VLAN 1-100 is switched to portA1 to forward.

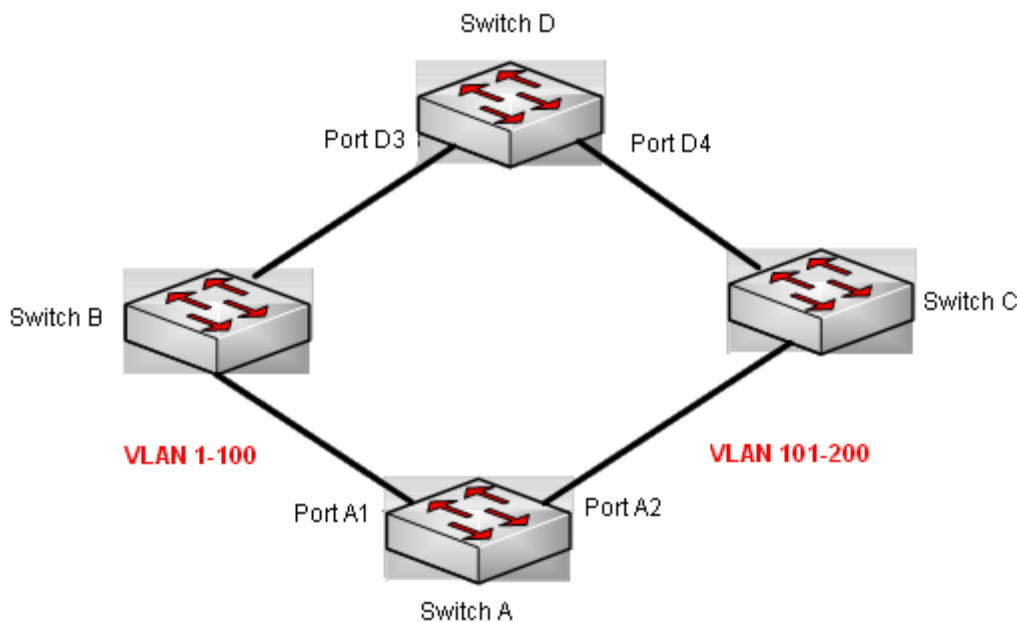

Figure 67-2 VLAN load balance

## 67.2 ULPP Configuration Task List

1. Create ULPP group globally
2. Configure ULPP group
3. Show and debug the relating information of ULPP

## 1. Create ULPP group globally

Command	Explanation
Global mode	
<b>ulpp group &lt;integer&gt;</b> <b>no ulpp group &lt;integer&gt;</b>	Configure and delete ULPP group globally.

## 2. Configure ULPP group

Command	Explanation
ULPP group configuration mode	
<b>preemption mode</b> <b>no preemption mode</b>	Configure the preemption mode of ULPP group. The no operation deletes the preemption mode.
<b>preemption delay &lt;integer&gt;</b> <b>no preemption delay</b>	Configure the preemption delay, the no operation restores the default value 30s.
<b>control vlan &lt;integer&gt;</b> <b>no control vlan</b>	Configure the sending control VLAN, no operation restores the default value 1.
<b>protect vlan-reference-instance</b> <b>&lt;instance-list&gt;</b> <b>no protect vlan-reference-instance</b> <b>&lt;instance-list&gt;</b>	Configure the protection VLANs, the no operation deletes the protection VLANs.
<b>flush enable mac</b> <b>flush disable mac</b>	Enable or disable sending the flush packets which update MAC address.
<b>flush enable arp</b> <b>flush disable arp</b>	Enable or disable sending the flush packets which delete ARP.
<b>description &lt;string&gt;</b> <b>no description</b>	Configure or delete ULPP group description.
Port mode	
<b>ulpp control vlan &lt;vlan-list&gt;</b> <b>no ulpp control vlan &lt;vlan-list&gt;</b>	Configure the receiving control VLANs, no operation restores the default value 1.
<b>ulpp flush enable mac</b> <b>ulpp flush disable mac</b>	Enable or disable receiving the flush packets which update the MAC address.
<b>ulpp flush enable arp</b> <b>ulpp flush disable arp</b>	Enable or disable receiving the flush packets which delete ARP.

<b>ulpp group &lt;integer&gt; master</b> <b>no ulpp group &lt;integer&gt; master</b>	Configure or delete the master port of ULPP group.
<b>ulpp group &lt;integer&gt; slave</b> <b>no ulpp group &lt;integer&gt; slave</b>	Configure or delete the slave port of ULPP group.

### 3. Show and debug the relating information of ULPP

Command	Explanation
Admin mode	
<b>show ulpp group [group-id]</b>	Show the configuration information of the configured ULPP group.
<b>show ulpp flush counter interface {ethernet &lt;IFNAME&gt;   &lt;IFNAME&gt;}</b>	Show the statistic information of the flush packets.
<b>show ulpp flush-receive-port</b>	Show flush type and control VLAN received by the port.
<b>clear ulpp flush counter interface &lt;name&gt;</b>	Clear the statistic information of the flush packets.
<b>debug ulpp flush {send   receive} interface &lt;name&gt;</b> <b>no debug ulpp flush {send   receive} interface &lt;name&gt;</b>	Show the information of the receiving and sending flush packets, the no operation disables the shown information.
<b>debug ulpp flush content interface &lt;name&gt;</b> <b>no debug ulpp flush content interface &lt;name&gt;</b>	Show the contents of the received flush packets, the no operation disables the showing.
<b>debug ulpp error</b> <b>no debug ulpp error</b>	Show the error information of ULPP, the no operation disables the showing.
<b>debug ulpp event</b> <b>no debug ulpp event</b>	Show the event information of ULPP, the no operation disables the showing.

## 67.3 ULPP Typical Examples

### 67.3.1 ULPP Typical Example1

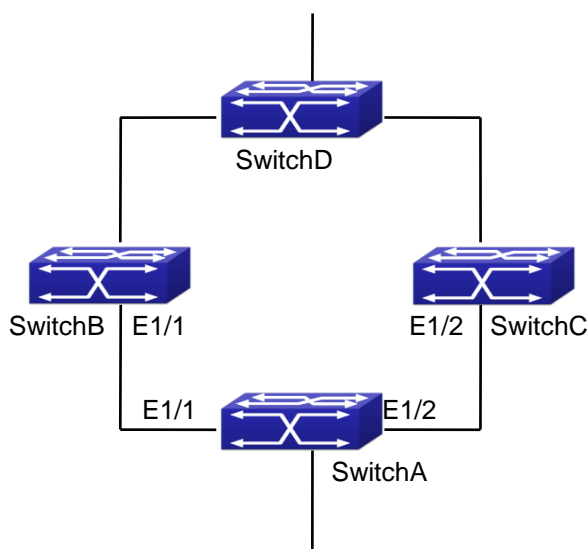

**Figure 67-3** ULPP typical example1

The above topology is the typical application environment of ULPP protocol.

SwitchA has two uplinks, they are SwitchB and SwitchC. When any protocols are not enabled, this topology forms a ring. For avoiding the loopback, SwitchA can configure ULPP protocol, the master port and the slave port of ULPP group. When both master port and slave port are up, the slave port will be set as standby state and will not forward the data packets. When the master port is down, the slave port will be set as forwarding state and switch to the uplink. SwitchB and SwitchC can enable the command that receives the flush packets, it is used to associate with ULPP protocol running of SwitchA to switch the uplink immediately and reduce the switch delay.

When configuring ULPP protocol of SwitchA, first, create a ULPP group and configure the protection VLAN of this group as vlan10, then configure interface Ethernet 1/0/1 as the master port, interface Ethernet 1/0/2 as the slave port, the control VLAN as 10. SwitchB and SwitchC configure the flush packets that receive ULPP.

SwitchA configuration task list:

```
Switch(Config)#vlan 10
Switch(Config-vlan10)#switchport interface ethernet 1/0/1; 1/0/2
Switch(Config-vlan10)#exit
Switch(Config)#spanning-tree mst configuration
Switch(Config-Mstp-Region)#instance 1 vlan 10
Switch(Config-Mstp-Region)#exit
Switch(Config)#ulpp group 1
Switch(ulpp-group-1)#protect vlan-reference-instance 1
Switch(ulpp-group-1)#control vlan 10
```

```

Switch(ulpp-group-1)#exit
Switch(Config)#interface ethernet 1/0/1
Switch(config-if-Ethernet1/0/1)# ulpp group 1 master
Switch(config-if-Ethernet1/0/1)#exit
Switch(Config)#interface Ethernet 1/0/2
Switch(config-if-Ethernet1/0/2)# ulpp group 1 slave
Switch(config-if-Ethernet1/0/2)#exit

```

SwitchB configuration task list:

```

Switch(Config)#vlan 10
Switch(Config-vlan10)#switchport interface ethernet 1/0/1
Switch(Config-vlan10)#exit
Switch(Config)#interface ethernet 1/0/1
Switch(config-if-Ethernet1/0/1)# ulpp flush enable mac
Switch(config-if-Ethernet1/0/1)# ulpp flush enable arp
Switch(config-if-Ethernet1/0/1)# ulpp control vlan 10

```

SwitchC configuration task list:

```

Switch(Config)#vlan 10
Switch(Config-vlan10)#switchport interface ethernet 1/0/2
Switch(Config-vlan10)#exit
Switch(Config)#interface ethernet 1/0/2
Switch(config-if-Ethernet1/0/2)# ulpp flush enable mac
Switch(config-if-Ethernet1/0/2)# ulpp flush enable arp
Switch(config-if-Ethernet1/0/2)# ulpp control vlan 10

```

## 67.3.2 ULPP Typical Example2

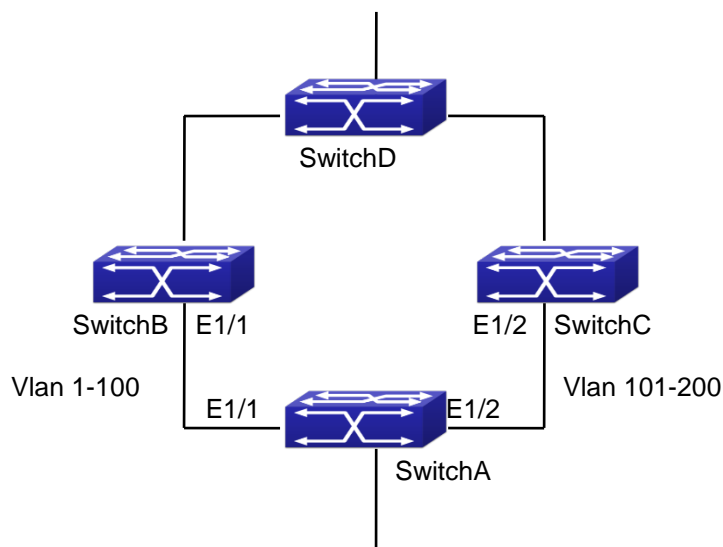

Figure 67-4 ULPP typical example2

---

ULPP can implement the VLAN-based load balance. As the picture illustrated, SwitchA configures two ULPP groups: port E1/0/1 is the master port and port 1/0/2 is the slave port in group1, port 1/0/2 is the master port and port 1/0/1 is the slave port in group2. The VLANs protected by group1 are 1-100 and by group2 are 101-200. Here both port E1/0/1 and port E1/0/2 at the forwarding state, the master port and the slave port mutually backup, respectively forward the packets of different VLAN ranges. When port E1/0/1 has the problem, the traffic of VLAN 1-200 are forwarded by port E1/0/2. When port E1/0/1 is recovering the normal state, still port E1/0/2 forwards the data of VLAN 101-200, the data of VLAN 1-100 are switched to port E1/0/1 to forward.

SwitchA configuration task list:

```
Switch(Config)#spanning-tree mst configuration
Switch(Config-Mstp-Region)#instance 1 vlan 1-100
Switch(Config-Mstp-Region)#instance 2 vlan 101-200
Switch(Config-Mstp-Region)#exit
Switch(Config)#ulpp group 1
Switch(ulpp-group-1)#protect vlan-reference-instance 1
Switch(ulpp-group-1)#preemption mode
Switch(ulpp-group-1)#exit
Switch(Config)#ulpp group 2
Switch(ulpp-group-2)#protect vlan-reference-instance 2
Switch(ulpp-group-2)#preemption mode
Switch(ulpp-group-2)#exit
Switch(Config)#interface ethernet 1/0/1
Switch(config-If-Ethernet1/0/1)#switchport mode trunk
Switch(config-If-Ethernet1/0/1)#ulpp group 1 master
Switch(config-If-Ethernet1/0/1)#ulpp group 2 slave
Switch(config-If-Ethernet1/0/1)#exit
Switch(Config)#interface Ethernet 1/0/2
Switch(config-If-Ethernet1/0/2)#switchport mode trunk
Switch(config-If-Ethernet1/0/2)# ulpp group 1 slave
Switch(config-If-Ethernet1/0/2)# ulpp group 2 master
Switch(config-If-Ethernet1/0/2)#exit
```

SwitchB configuration task list:

```
Switch(Config)#interface ethernet 1/0/1
Switch(config-If-Ethernet1/0/1)#switchport mode trunk
Switch(config-If-Ethernet1/0/1)# ulpp flush enable mac
Switch(config-If-Ethernet1/0/1)# ulpp flush enable arp
```

SwitchC configuration task list:

```
Switch(Config)#interface ethernet 1/0/2
Switch(config-If-Ethernet1/0/2)# switchport mode trunk
```

```
Switch(config-If-Ethernet1/0/2)# ulpp flush enable mac  
Switch(config-If-Ethernet1/0/2)# ulpp flush enable arp
```

## 67.4 ULPP Troubleshooting

- At present, configuration of more than 2 multi-uplinks is allowed, but it may cause loopback, so is not recommended.
- With the normal configuration, if the broadcast storm happen or the communication along the ring is broken, please enable the debug of ULPP, copy the debug information of 3 minutes and the configuration information, send them to our technical service center.



---

# Chapter 68 ULSM Configuration

## 68.1 Introduction to ULSM

ULSM (Uplink State Monitor) is used to process the port state synchronization. Each ULSM group is made up of the uplink port and the downlink port, both the uplink port and the downlink port may be multiple. The port may be a physical port or a port channel, but it can not be a member port of a port channel, and each port only belongs to one ULSM group.

The uplink port is the monitored port of ULSM group. When all uplink ports are down or there is no uplink port in ULSM group, ULSM group state is down. ULSM group state is up as long as one uplink port is up.

The downlink port is the controlled port, its state changes along with Up/Down of ULSM group and is always the same with ULSM group state.

ULSM associates with ULPP to enable the downstream device to apperceive the link problem of the upstream device and process correctly. As the picture illustrated, SwitchA configures ULPP, here the traffic is forwarded by port A1. If the link between SwitchB and Switch D has the problem, SwitchA can not apperceive the problem of the upstream link and sequentially forward the traffic from port A1, cause traffic losing.

Configuring ULSM on SwitchB can solve the above problems. The steps are: set port B5 as the uplink port of ULSM group, port B6 as the downlink port. When the link between SwitchB and SwitchD has the problem, both the downlink port B6 and the state of ULSM group are down. It causes Switch A on which ULPP is configured to process uplink switchover and avoid the data dropped.

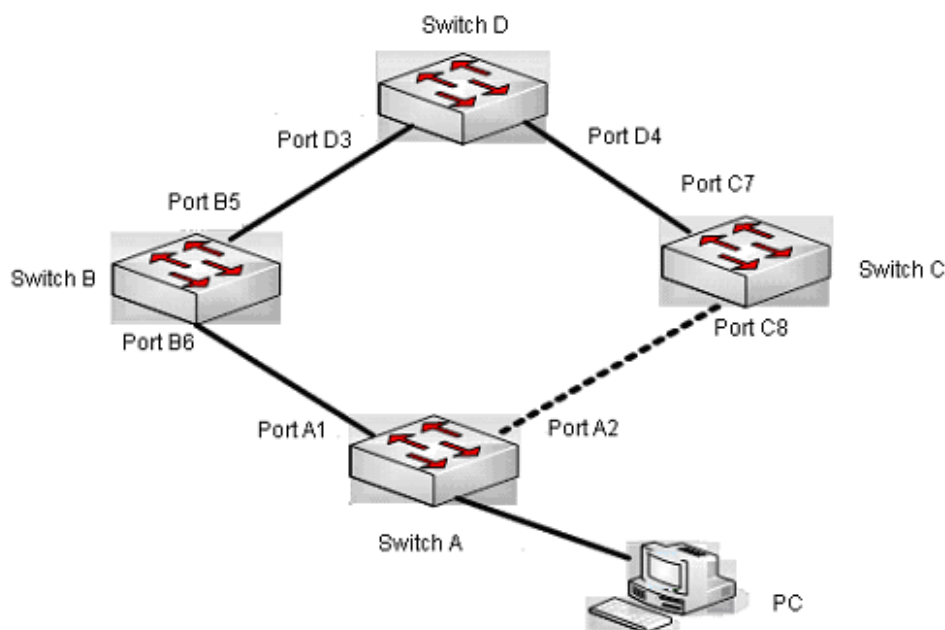

Figure 68-1 ULSM using scene

---

## 68.2 ULSM Configuration Task List

1. Create ULSM group globally
2. Configure ULSM group
3. Show and debug the relating information of ULSM

### 1. Create ULSM group globally

Command	explanation
Global mode	
<b>ulsm group &lt;group-id&gt;</b> <b>no ulsm group &lt;group-id&gt;</b>	Configure and delete ULSM group globally.

### 2. Configure ULSM group

Command	explanation
Port mode	
<b>ulsm group &lt;group-id&gt; {uplink   downlink}</b> <b>no ulsm group &lt;group-id&gt; {uplink   downlink}</b>	Configure the uplink/downlink port of ULSM group, the no command deletes the uplink/downlink port.

### 3. Show and debug the relating information of ULSM

Command	Explanation
Admin mode	
<b>show ulsm group [group-id]</b>	Show the configuration information of ULSM group.
<b>debug ulsm event</b> <b>no debug ulsm event</b>	Show the event information of ULSM, the no operation disables the shown information.

## 68.3 ULSM Typical Example

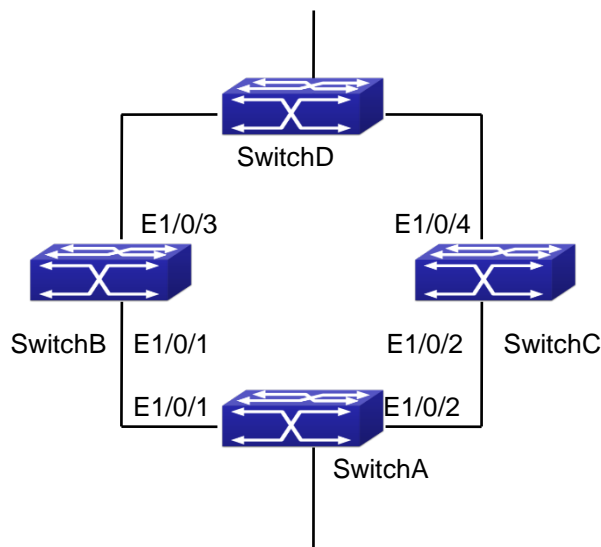

Figure 68-2 ULSM typical example

The above topology is the typical application environment which is used by ULSM and ULPP protocol.

ULSM is used to process the port state synchronization, its independent running is useless, so it usually associates with ULPP protocol to use. In the topology, SwitchA enables ULPP protocol, it is used to switch the uplink. SwitchB and SwitchC enable ULSM protocol to monitor whether the uplink is down. If it is down, then ULSM will execute the down operation for the downlink port to shutdown it, so ULPP protocol of Switch A executes the relative operation of the uplink switchover.

SwitchA configuration task list:

```
Switch(Config)#spanning-tree mst configuration
Switch(Config-Mstp-Region)#instance 1 vlan 1
Switch(Config-Mstp-Region)#exit
Switch(Config)#ulpp group 1
Switch(ulpp-group-1)#protect vlan-reference-instance 1
Switch(ulpp-group-1)#exit
Switch(Config)#interface ethernet 1/0/1
Switch(config-If-Ethernet1/0/1)# ulpp group 1 master
Switch(config-If-Ethernet1/0/1)#exit
Switch(Config)#interface Ethernet 1/0/2
Switch(config-If-Ethernet1/0/2)# ulpp group 1 slave
Switch(config-If-Ethernet1/0/2)#exit
```

SwitchB configuration task list:

```
Switch(Config)#ulsm group 1
Switch(Config)#interface ethernet 1/0/1
```

```
Switch(config-If-Ethernet1/0/1)#ulsm group 1 downlink
Switch(config-If-Ethernet1/0/1)#exit
Switch(Config)#interface ethernet 1/0/3
Switch(config-If-Ethernet1/0/3)#ulsm group 1 uplink
Switch(config-If-Ethernet1/0/3)#exit
```

SwitchC configuration task list:

```
Switch(Config)#ulsm group 1
Switch(Config)#interface ethernet 1/0/2
Switch(config-If-Ethernet1/0/2)#ulsm group 1 downlink
Switch(config-If-Ethernet1/0/2)#exit
Switch(Config)#interface ethernet 1/0/4
Switch(config-If-Ethernet1/0/4)#ulsm group 1 uplink
Switch(config-If-Ethernet1/0/4)#exit
```

## 68.4 ULSM Troubleshooting

- With the normal configuration, if the downlink port does not respond to the down event of the uplink port, please enable the debug function of ULSM, copy the debug information of 3 minutes and the configuration information, and send them to our technical service center.

---

# Chapter 69 Mirror Configuration

## 69.1 Introduction to Mirror

Mirror functions include port mirror function, CPU mirror function, flow mirror function.

Port mirror refers to the duplication of data frames sent/received on a port to another port. The duplicated port is referred to as mirror source port and the duplicating port is referred to as mirror destination port. A protocol analyzer (such as Sniffer) or a RMON monitor will be connected at mirror destination port to monitor and manage the network, and diagnose the problems in the network.

CPU mirror function means that the switch exactly copies the data frames received or sent by the CPU to a port. Flow mirror function means that the switch exactly copies the data frames received or by the specified rule of a port to another port. The flow mirror will take effect only the specified rule is permit.

A chassis switch supports at most 4 mirror destination ports, each boardcard allows a source or destination port of a mirror session. At present, each box switch can set many mirror sessions. For SGS-6341 Series box switches, many mirror sessions are not supported by SGS-6341 Series switch. There is no limitation on mirror source ports, one port or several ports is allowed. When there are more than one source ports, they can be in the same VLAN or in different VLAN. The source port and destination port can be in different VLAN.

## 69.2 Mirror Configuration Task List

1. Specify mirror destination port
2. Specify mirror source port
3. Specify flow mirror source

### 1. Specify mirror destination port

Command	Explanation
Global mode	
<b>monitor session &lt;session&gt; destination interface &lt;interface-number&gt;</b> <b>no monitor session &lt;session&gt; destination interface &lt;interface-number&gt;</b>	Specifies mirror destination port; the no command deletes mirror destination source port.

## 2. Specify mirror source port

Command	Explanation
Global mode	
<b>monitor session &lt;session&gt; source</b> {interface <interface-list> / cpu [slot <slotnum> ]} {rx  tx  both} <b>no monitor session &lt;session&gt; source</b> {interface <interface-list> / cpu [slot <slotnum> ]}	Specifies mirror source port; the no command deletes mirror source port.

## 3. Specify flow mirror source

Command	Explanation
Global mode	
<b>monitor session &lt;session&gt; source</b> {interface <interface-list>} access-group <num> {rx tx both} <b>no monitor session &lt;session&gt; source</b> {interface <interface-list>} access-group <num>	Specifies flow mirror source port and apply rule; the no command deletes flow mirror source port.

## 69.3 Mirror Examples

### Example:

The requirement of the configurations is shown as below: to monitor at interface 1 the data frames sent out by interface 9 and received from interface 7, sent and received by CPU, and the data frames received by interface 15 and matched by rule 120(The source IP address is 1.2.3.4 and the destination IP address is 5.6.7.8).

Configuration guidelines:

1. Configure interface 1 to be a mirror destination interface.
2. Configure the interface 7 ingress and interface 9 egress to be mirrored source.
3. Configure the CPU as one of the source.
4. Configure access list 120.
5. Configure access 120 to binding interface 15 ingress.

**Configuration procedure is as follows:**

```
Switch(config)#monitor session 4 destination interface ethernet 1/0/1
Switch(config)#monitor session 4 source interface ethernet 1/0/7 rx
Switch(config)#monitor session 4 source interface ethernet 1/0/9 tx
```

```
Switch(config)#access-list 120 permit tcp 1.2.3.4 0.0.0.255 5.6.7.8 0.0.0.255
Switch(config)#monitor session 4 source interface ethernet 1/0/15 access-list 120 rx
```

## 69.4 Device Mirror Troubleshooting

If problems occur on configuring port mirroring, please check the following first for causes:

- Whether the mirror destination port is a member of a TRUNK group or not, if yes, modify the TRUNK group.
- If the throughput of mirror destination port is smaller than the total throughput of mirror source port(s), the destination port will not be able to duplicate all source port traffic; please decrease the number of source ports, duplicate traffic for one direction only or choose a port with greater throughput as the destination port. Mirror destination port can not be pulled into Isolate vlan, or will affect mirror between VLAN.

---

# Chapter 70 RSPAN Configuration

## 70.1 Introduction to RSPAN

Port mirroring refers to the duplication of data frames sent/received on a port to another port. The duplicated port is referred to as mirror source port and the duplicating port is referred to as mirror destination port. It is more convenience for network administrator to monitor and manage the network and diagnostic after the mirroring function achieved. But it only used for such instance that the mirror source port and the mirror destination ports are located in the same switch.

RSPAN (remote switched port analyzer) refers to remote port mirroring. It eliminates the limitation that the source port and the destination port must be located on the same switch. This feature makes it possible for the source port and the destination port to be located on different devices in the network, and facilitates the network administrator to manage remote switches. It can't forward traffic flows on remote mirror VLAN.

There are three types of switches with the RSPAN enabled:

1. Source switch: The switch to which the monitored port belongs. The source switch copies the mirrored traffic flows to the Remote VLAN, and then through Layer 2 forwarding, the mirrored flows are sent to an intermediate switch or destination switch.
2. Intermediate switch: Switches between the source switch and destination switch on the network. Intermediate switch forwards mirrored flows to the next intermediate switch or the destination switch. Circumstances can occur where no intermediate switch is present, if a direct connection exists between the source and destination switches.
3. Destination switch: The switch to which the destination port for remote mirroring belongs. It forwards mirrored flows it received from the Remote VLAN to the monitoring device through the destination port.

When configuring the RSPAN mirroring of the source switch, reflector port mode or destination mirror port mode can be selected. The destination switch will redirect all the data frames in the RSPAN VLAN to the RSPAN destination port. For RSPAN mirroring, normal mode and advanced mode can be chosen, normal is introduced by default and fit the normal user. The advanced mode fit the advanced user.

1. Advanced mode: To redirect data frames in RSPAN VLAN to the RSPAN destination port, the intermediary and destination devices should support the redirection of flow.
2. Normal mode: To configure the RSPAN destination port in the RSPAN VLAN. Thus, datagrams in the RSPAN VLAN will be broadcasted to the destination port. In this mode, the destination port should be in RSPAN VLAN, and the source port should not be configured for broadcasting storm control. TRUNK ports should be configured carefully in order not to forward RSPAN datagrams to external networks. The normal mode has the benefit of easy configuration, and reduced system resources.

To be noticed: Normal mode is introduced by default. When using the normal mode, datagrams with reserved MAC addresses cannot be broadcasted.



---

For chassis switches, at most 4 mirror destination ports are supported, and source or destination port of one mirror session can be configured on each line card. For box switches, only one mirror session can be configured. The number of the source mirror ports is not limited, and can be one or more. Multiple source ports are not restricted to be in the same VLAN. The destination port and the source ports can be in different VLAN.

For configuration of RSPAN, a dedicated RSPAN VLAN should be configured first for carrying the RSPAN datagrams. The default VLAN, dynamic VLAN, private VLAN, multicast VLAN, and the layer 3 interface enabled VLAN cannot be configured as the RSPAN VLAN. The reflector port must belong to the RSPAN VLAN. The destination port should be connected to the Monitor and the configured as access port or the TRUNK port. The RSPAN reflector port will be working dedicatedly for mirroring, when a port is configured as a reflector port, it will discards all the existing connections to the remote peer, disable configurations related to loopback interfaces, and stop forwarding datagram. Connectivity between the source and destination switch for Remote VLAN, should be made sure by configuration.

To be noticed:

1. Layer 3 interfaces related to RSPAN VLAN should not be configured on the source, intermediate, and the destination switches, or the mirrored datagrams may be discarded.
2. For the source and intermediate switches in the RSPAN connections, the native VLAN of TRUNK port cannot be configured as the RSPAN VLAN, Otherwise the RSPAN tag will be disposed before reaching the destination switches.
3. The source port, in access or trunk mode, should not be added to RSPAN VLAN if advanced RSPAN mode is chosen. When the reflector port is used for an inter-card mirroring of CPU TX data, it must be configured as TRUNK port and allows the RSPAN VLAN data passing, the Native VLAN should not be configured as RSPAN VLAN.
4. When configuring the remote mirroring function, the network bandwidth should be considered in order to carry the network flow and the mirrored flow.

Keywords:

RSPAN: Remote Switched Port Analyzer

RSPAN VLAN: Dedicated VLAN for RSPAN

RSPAN Tag: The VLAN tag which is attached to MTP of the RSPAN datagrams.

Reflector Port: The local mirroring port between the RSPAN source and destination ports, which is not directly connected to the intermediate switches.

## 70.2 RSPAN Configuration Task List

1. Configure RSPAN VLAN
2. Configure mirror source port
3. Configure mirror destination port
4. Configure reflector port
5. Configure remote VLAN of mirror group

## 1. Configure RSPAN VLAN

Command	Explanation
VLAN Configuration Mode	
<b>remote-span</b> <b>no remote-span</b>	To configure the specified VLAN as RSPAN VLAN. The no command will remove the configuration of RSPAN VLAN.

## 2. Configure mirror source port

Command	Explanation
Global Mode	
<b>monitor session &lt;session&gt; source</b> <b>{interface &lt;interface-list&gt; / cpu [slot</b> <b>&lt;slotnum&gt;]} {rx  tx  both}</b> <b>no monitor session &lt;session&gt; source</b> <b>{interface &lt;interface-list&gt; / cpu [slot</b> <b>&lt;slotnum&gt;]}</b>	To configure mirror source port; The no command deletes the mirror source port.

## 3. Configure mirror destination port

Command	Explanation
Global Mode	
<b>monitor session &lt;session&gt; destination</b> <b>interface &lt;interface-number&gt;</b> <b>no monitor session &lt;session&gt; destination</b> <b>interface &lt;interface-number&gt;</b>	To configure mirror destination interface; The no command deletes the mirror destination port.

## 4. Configure reflector port

Command	Explanation
Global Mode	
<b>monitor session &lt;session&gt; reflector-port</b> <b>&lt;interface-number&gt;</b> <b>no monitor session &lt;session&gt; reflector-port</b>	To configure the interface to reflector port; The no command deletes the reflector port.

## 5. Configure remote VLAN of mirror group

Command	Explanation
Global Mode	
<b>monitor session &lt;session&gt;</b> <b>remote vlan &lt;vid&gt;</b> <b>no monitor session &lt;session&gt; remote vlan</b>	To configure remote VLAN of mirror group, the no command deletes the remote VLAN of mirror group.

## 70.3 Typical Examples of RSPAN

Before RSPAN is invented, network administrators had to connect their PCs directly to the switches, in order to check the statistics of the network.

However, with the help of RSPAN, the network administrators can configure and supervise the switches remotely, which brings more efficiency. The figure below shows a sample application of RSPAN.

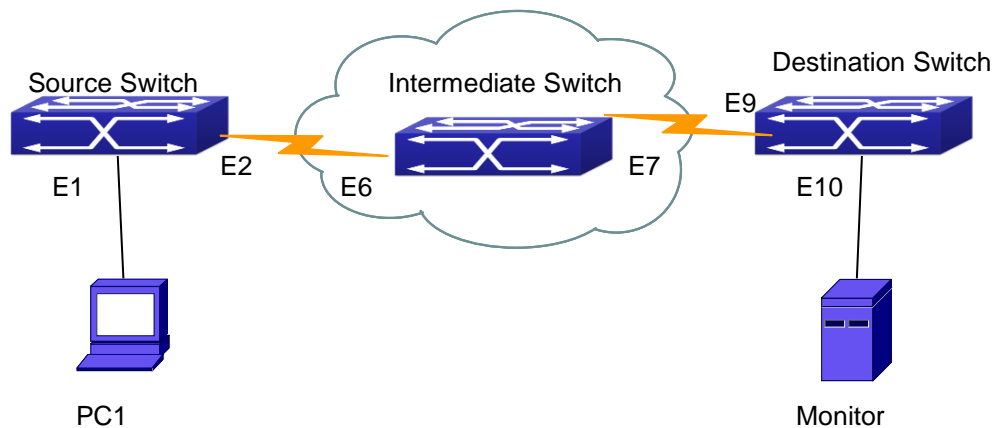

**Figure 70-1** RSPAN Application Sample

Two configuration solutions can be chosen for RSPAN: the first is without reflector port, and the other is with reflector port. For the first one, only one fixed port can be connected to the intermediate switch. However, no reflector port has to be configured. This maximizes the usage of switch ports. For the latter one, the port connected to the intermediate switch is not fixed. Datagrams can be broadcasted in the RSPAN VLAN through the loopback, which is much more flexible.

The normal mode configuration is show as below:

Solution 1:

**Source switch:**

Interface ethernet 1/0/1 is the source port for mirroring.

Interface ethernet 1/0/2 is the destination port which is connected to the intermediate switch.

RSPAN VLAN is 5.

```
Switch(config)#vlan 5
Switch(Config-Vlan5)#remote-span
Switch(Config-Vlan5)#exit
Switch(config)#interface ethernet 1/0/2
Switch(Config-If-Ethernet1/0/2)#switchport mode trunk
Switch(Config-If-Ethernet1/0/2)#exit
Switch(config)#monitor session 1 source interface ethernet1/0/1 rx
Switch(config)#monitor session 1 destination interface ethernet1/0/2
Switch(config)#monitor session 1 remote vlan 5
```

---

**Intermediate switch:**

Interface ethernet1/0/6 is the source port which is connected to the source switch.

Interface ethernet1/0/7 is the destination port which is connected to the intermediate switch. The native VLAN of this port cannot be configured as RSPAN VLAN, or the mirrored data may not be carried by the destination switch.

RSPAN VLAN is 5.

```
Switch(config)#vlan 5
Switch(Config-Vlan5)#remote-span
Switch(Config-Vlan5)#exit
Switch(config)#interface ethernet 1/0/6-7
Switch(Config-If-Port-Range)#switchport mode trunk
Switch(Config-If-Port-Range)#exit
```

**Destination switch:**

Interface ethernet1/0/9 is the source port, which is connected to the source switch.

Interface ethernet1/0/10 is the destination port which is connected to the monitor. This port is required to be configured as an access port, and belong to the RSPAN VLAN.

RSPAN VLAN is 5.

```
Switch(config)#vlan 5
Switch(Config-Vlan5)#remote-span
Switch(Config-Vlan5)#exit
Switch(config)#interface ethernet 1/0/9
Switch(Config-If-Ethernet1/0/9)#switchport mode trunk
Switch(Config-If-Ethernet1/0/9)#exit
Switch(config)#interface ethernet 1/0/10
Switch(Config-If-Ethernet1/0/10)#switchport access vlan 5
Switch(Config-If-Ethernet1/0/10)#exit
```

Solution 2:

**Source switch:**

Interface ethernet 1/0/1 is the source port.

Interface ethernet 1/0/2 is the TRUNK port, which is connected to the intermediate switch. The native VLAN should not be a RSPAN VLAN.

Interface Ethernet 1/0/3 is a reflector port. The reflector port belongs to the RSPAN VLAN, it is access port or TRUNK port of the RSPAN VLAN.

RSPAN VLAN is 5.

```
Switch(config)#vlan 5
Switch(Config-Vlan5)#remote-span
Switch(Config-Vlan5)#exit
```

```
Switch(config)#interface ethernet 1/0/2
Switch(Config-If-Ethernet1/0/2)#switchport mode trunk
Switch(Config-If-Ethernet1/0/2)#exit
Switch(config)#interface ethernet 1/0/3
Switch(Config-If-Ethernet1/0/3)#switchport mode trunk
Switch(Config-If-Ethernet1/0/3)#exit
Switch(config)#monitor session 1 source interface ethernet1/0/1 rx
Switch(config)#monitor session 1 reflector-port ethernet1/0/3
Switch(config)#monitor session 1 remote vlan 5
```

#### **Intermediate switch:**

Interface ethernet1/0/6 is the source port which is connected to the source switch.

Interface ethernet1/0/7 is the destination port which is connected to the destination switch. The native VLAN of the port should not be configured as RSPAN VLAN, or the mirrored data may not be carried by the destination switch.

RSPAN VLAN is 5.

```
Switch(config)#vlan 5
Switch(Config-Vlan5)#remote-span
Switch(Config-Vlan5)#exit
Switch(config)#interface ethernet 1/0/6-7
Switch(Config-If-Port-Range)#switchport mode trunk
Switch(Config-If-Port-Range)#exit
```

#### **Destination switch:**

Interface ethernet1/0/9 is the source port which is connected to the source switch.

Interface ethernet1/0/10 is the destination port which is connected to the monitor. This port is required to be configured as an access port, and belong to the RSPAN VLAN.

RSPAN VLAN is 5.

```
Switch(config)#vlan 5
Switch(Config-Vlan5)#remote-span
Switch(Config-Vlan5)#exit
Switch(config)#interface ethernet 1/0/9
Switch(Config-If-Ethernet1/0/9)#switchport mode trunk
Switch(Config-If-Ethernet1/0/9)#exit
Switch(config)#interface ethernet 1/0/10
Switch(Config-If-Ethernet1/0/10)#switchport access vlan 5
Switch(Config-If-Ethernet1/0/10)#exit
```

---

## 70.4 RSPAN Troubleshooting

Due to the following reasons, RSPAN may not function:

- Whether the destination mirror port is a member of the Port-channel group. If so, please change the Port-channel group configuration;
- The throughput the destination port is less than the total throughput of the source mirror ports. If so, the destination cannot catch all the datagrams from every source ports. To solve the problem, please reduce the number of the source ports, or mirror only single direction data flow, or choose some other port with higher capacity as the destination port.
- Between the source switch and the intermediate switch, whether the native VLAN of the TRUNK ports is configured as RSPAN VLAN. If so, please change the native VLAN for the TRUNK ports.

# Chapter 71 sFlow Configuration

## 71.1 Introduction to sFlow

The sFlow (RFC 3176) is a protocol based on standard network export and used on monitoring the network traffic information developed by the InMon Company. The monitored switch or router sends data to the client analyzer through its main operations such as sampling and statistic, then the analyzer will analyze according to the user requirements so to monitor the network.

A sFlow monitor system includes: sFlow proxy, central data collector and sFlow analyzer. The sFlow proxy collects data from the switch using sampling technology. The sFlow collector is for formatting the sample data statistic which is to be forwarded to the sFlow analyzer which will analyze the sample data and perform corresponding measure according to the result. Our switch here acts as the proxy and central data collector in the sFlow system. We have achieved data sampling and statistic targeting physical port.

Our data sample includes the IPv4 and IPv6 packets. Extensions of other types are not supported so far. As for non IPv4 and IPv6 packet, the unify HEADER mode will be adopted following the requirements in RFC3176, copying the head information of the packet based on analyzing the type of its protocol.

The latest sFlow protocol presented by InMon Company is the version 5. Since it is the version 4 which is realized in the RFC3176, version conflict might exist in some case such as the structure and the packet format. This is because the version 5 has not become the official protocol, so, in order to be compatible with current applications, we will continue to follow the RFC3176.

## 71.2 sFlow Configuration Task List

### 1. Configure sFlow Collector address

Command	Explanation
Global mode and Port Mode	
<b>sflow destination &lt;collector-address&gt; [&lt;collector-port&gt;] no sflow destination</b>	Configure the IP address and port number of the host in which the sFlow analysis software is installed. As for the ports, if IP address is configured on the port, the port configuration will be applied, or else will be applied the global configuration. The “ <b>no sflow destination</b> ” command restores to the default port value and deletes the IP address.

## 2. Configure the sFlow proxy address

Command	Explanation
Global Mode	
<b>sflow agent-address &lt;collector-address&gt;</b> <b>no sflow agent-address</b>	Configure the source IP address applied by the sFlow proxy; the “no” form of the command deletes this address.

## 3. Configure the sFlow proxy priority

Command	Explanation
Global Mode	
<b>sflow priority &lt;priority-value&gt;</b> <b>no sflow priority</b>	Configure the priority when sFlow receives packet from the hardware; the “no sflow priority” command restores to the default

## 4. Configure the packet head length copied by sFlow

Command	Explanation
Port Mode	
<b>sflow header-len &lt;length-vlaue&gt;</b> <b>no sflow header-len</b>	Configure the length of the packet data head copied in the sFlow data sampling; the “no” form of this command restores to the default value.

## 5. Configure the max data head length of the sFlow packet

Command	Explanation
Port Mode	
<b>sflow data-len &lt;length-vlaue&gt;</b> <b>no sflow data-len</b>	Configure the max length of the data packet in sFlow; the “no” form of this command restores to the default.

## 6. Configure the sampling rate value

Command	Explanation
Port Mode	
<b>sflow rate {input &lt;input-rate&gt;   output &lt;output-rate &gt;}</b> <b>no sflow rate [input   output]</b>	Configure the sampling rate when sFlow performing hardware sampling. The “no” command deletes the rate value.

## 7. Configure the sFlow statistic sampling interval

Command	Explanation
---------	-------------



Port Mode	
<b>sflow counter-interval &lt;interval-value&gt;</b> <b>no sflow counter-interval</b>	Configure the max interval when sFlow performing statistic sampling. The “no” form of this command deletes

### 8. Configure the analyzer used by sFlow

Command	Explanation
Port Mode	
<b>sflow analyzer sflowtrend</b> <b>no sflow analyzer sflowtrend</b>	Configure the analyzer used by sFlow, the no command deletes the analyzer.

## 71.3 sFlow Examples

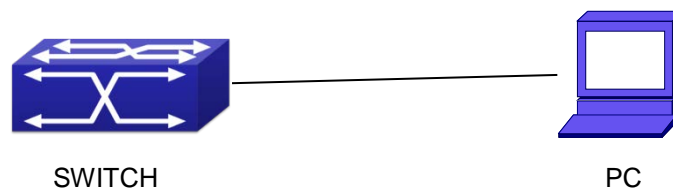

**Figure 71-1** sFlow configuration topology

As shown in the figure, sFlow sampling is enabled on the port 1/0/1 and 1/0/2 of the switch. Assume the sFlow analysis software is installed on the PC with the address of 192.168.1.200. The address of the layer 3 interface on the SwitchA connected with PC is 192.168.1.100. A loopback interface with the address of 10.1.144.2 is configured on the SwitchA. sFlow configuration is as follows:

**Configuration procedure is as follows:**

```
Switch#config
Switch (config)#sflow ageng-address 10.1.144.2
Switch (config)#sflow destination 192.168.1.200
Switch (config)#sflow priority 1
Switch (config)# interface ethernet1/0/1
Switch (Config-If-Ethernet1/0/1)#sflow rate input 10000
Switch (Config-If-Ethernet1/0/1)#sflow rate output 10000
Switch (Config-If-Ethernet1/0/1)#sflow counter-interval 20
Switch (Config-If-Ethernet1/0/1)#exit
Switch (config)# interface ethernet1/0/2
Switch (Config-If-Ethernet1/0/2)#sflow rate input 20000
Switch (Config-If-Ethernet1/0/2)#sflow rate output 20000
Switch (Config-If-Ethernet1/0/2)#sflow counter-interval 40
```

## 71.4 sFlow Troubleshooting

In configuring and using sFlow, the sFlow server may fail to run properly due to physical connection failure, wrong configuration, etc. The user should ensure the following:

- Ensure the physical connection is correct
- Guarantee the address of the sFlow analyzer configured under global or port mode is accessible.
- If traffic sampling is required, the sampling rate of the interface must be configured
- If statistic sampling is required, the statistic sampling interval of the interface must be configured

If the examination remains unsolved, please contact with the technical service center of our company.

---

# Chapter 72 SNTP Configuration

## 72.1 Introduction to SNTP

The Network Time Protocol (NTP) is widely used for clock synchronization for global computers connected to the Internet. NTP can assess packet sending/receiving delay in the network, and estimate the computer's clock deviation independently, so as to achieve high accuracy in network computer clocking. In most positions, NTP can provide accuracy from 1 to 50ms according to the characteristics of the synchronization source and network route.

Simple Network Time Protocol (SNTP) is the simplified version of NTP, removing the complex algorithm of NTP. SNTP is used for hosts who do not require full NTP functions; it is a subset of NTP. It is common practice to synchronize the clocks of several hosts in local area network with other NTP hosts through the Internet, and use those hosts to provide time synchronization service for other clients in LAN. The figure below depicts a NTP/SNTP application network topology, where SNTP mainly works between second level servers and various terminals since such scenarios do not require very high time accuracy, and the accuracy of SNTP (1 to 50 ms) is usually sufficient for those services.

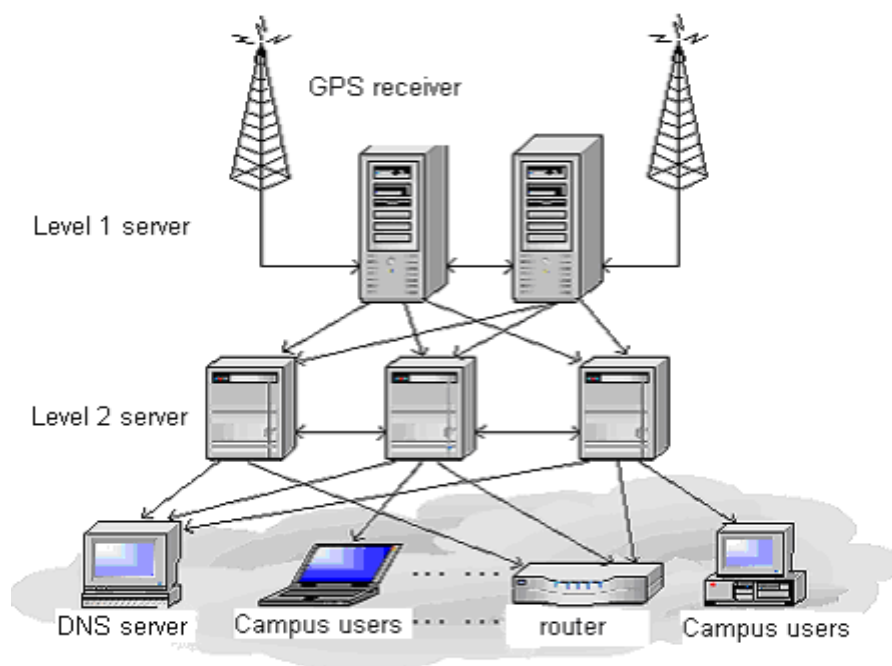

**Figure 72-1** Working Scenario

Switch implements SNTPv4 and supports SNTP client unicast as described in RFC2030; SNTP client multicast and unicast are not supported, nor is the SNTP server function.

## 72.2 Typical Examples of SNTP Configuration

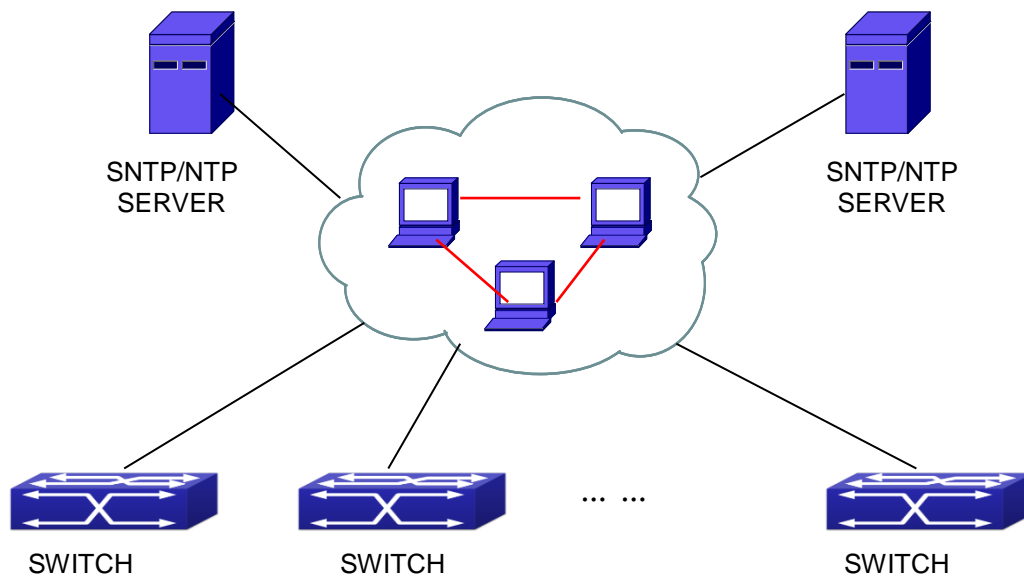

**Figure 72-2** Typical SNTP Configuration

All switches in the autonomous zone are required to perform time synchronization, which is done through two redundant SNTP/NTP servers. For time to be synchronized, the network must be properly configured. There should be reachable route between any switch and the two SNTP/NTP servers.

Example: Assume the IP addresses of the SNTP/NTP servers are 10.1.1.1 and 20.1.1.1, respectively, and SNTP/NTP server function (such as NTP master) is enabled, then configurations for any switch should like the following:

```
Switch#config
Switch(config)#sntp server 10.1.1.1
```

---

# Chapter 73 NTP Function Configuration

## 73.1 Introduction to NTP Function

The NTP (Network Time Protocol) synchronizes timekeeping spans WAN and LAN among distributed time servers and clients, it can get millisecond precision. The introduction of event, state, transmit function and action are defined in RFC-1305.

The purpose of using NTP is to keep consistent timekeeping among all clock-dependent devices within the network so that the devices can provide diverse applications based on the consistent time.

For a local system running NTP, its time can be synchronized by other reference sources and can be used as a reference source to synchronize other clocks, also can synchronize each other by transmit NTP packets.

## 73.2 NTP Function Configuration Task List

1. To enable NTP function
2. To configure NTP server function
3. To configure the max number of broadcast or multicast servers supported by the NTP client
4. To configure time zone
5. To configure NTP access control list
6. To configure NTP authentication
7. To specified some interface as NTP broadcast/multicast client interface
8. To configure some interface can't receive NTP packets
9. Display information
10. Debug

### 1. To enable NTP function

Command	Explication
Global Mode	
<b>ntp enable</b> <b>ntp disable</b>	To enable or disable NTP function.

### 2. To configure NTP server function

Command	Explication
Global Mode	

<pre>ntp server {&lt;ip-address&gt; / &lt;ipv6-address&gt;} [version &lt;version_no&gt;] [key &lt;key-id&gt;] no ntp server {&lt;ip-address&gt; / &lt;ipv6-address&gt;}</pre>	To enable the specified time server of time source.
---	---

### 3. To configure the max number of broadcast or multicast servers supported by the NTP client

Command	Explication
Global Mode	
<pre>ntp broadcast server count &lt;number&gt; no ntp broadcast server count</pre>	Set the max number of broadcast or multicast servers supported by the NTP client. The no operation will cancel the configuration and restore the default value.

### 4. To configure time zone

Command	Explication
Global Mode	
<pre>clock timezone WORD {add   subtract} &lt;0-23&gt; [&lt;0-59&gt;] no clock timezone WORD</pre>	This command configures timezone in global mode, the no command deletes the configured timezone.

### 5. To configure NTP access control list

Command	Explication
Global Mode	
<pre>ntp access-group server &lt;acl&gt; no ntp access-group server &lt; acl&gt;</pre>	To configure NTP server access control list.

### 6. To configure NTP authentication

Command	Explication
Global Mode	
<pre>ntp authenticate no ntp authenticate</pre>	To enable NTP authentication function.
<pre>ntp authentication-key &lt;key-id&gt; md5 &lt;value&gt; no ntp authentication-key &lt;key-id&gt;</pre>	To configure authentication key for NTP authentication.
<pre>ntp trusted-key &lt;key-id&gt; no ntp trusted-key &lt;key-id&gt;</pre>	To configure trusted key.

---

## 7. To specified some interface as NTP broadcast/multicast client interface

Command	Explication
Interface Configuration Mode	
<b>ntp broadcast client</b> <b>no ntp broadcast client</b>	To configure specified interface to receive NTP broadcast packets.
<b>ntp multicast client</b> <b>no ntp multicast client</b>	To configure specified interface to receive NTP multicast packets.
<b>ntp ipv6 multicast client</b> <b>no ntp ipv6 multicast client</b>	To configure specified interface to receive IPv6 NTP multicast packets.

## 8. To configure some interface can't receive NTP packets

Command	Explication
Interface Configuration Mode	
<b>ntp disable</b> <b>no ntp disable</b>	To disable the NTP function.

## 9. Display information

Command	Explication
Admin Mode	
<b>show ntp status</b>	To display the state of time synchronize.
<b>show ntp session [ &lt;ip-address&gt;   &lt;ipv6-address&gt; ]</b>	To display the information of NTP session.

## 10. Debug

Command	Explication
Admin Mode	
<b>debug ntp authentication</b> <b>no debug ntp authentication</b>	To enable debug switch of NTP authentication.
<b>debug ntp packets [send   receive]</b> <b>no debug ntp packets [send   receive]</b>	To enable debug switch of NTP packet information.
<b>debug ntp adjust</b> <b>no debug ntp adjust</b>	To enable debug switch of time update information.

<b>debug ntp sync</b> <b>no debug ntp sync</b>	To enable debug switch of time synchronize information.
<b>debug ntp events</b> <b>no debug ntp events</b>	To enable debug switch of NTP event information.

## 73.3 Typical Examples of NTP Function

A client switch wanted to synchronize time with time server in network, there is two time server in network, the one is used as host, the other is used as standby, the connection and configuration as follows (Switch A and Switch B are the switch or route which support NTP server ):

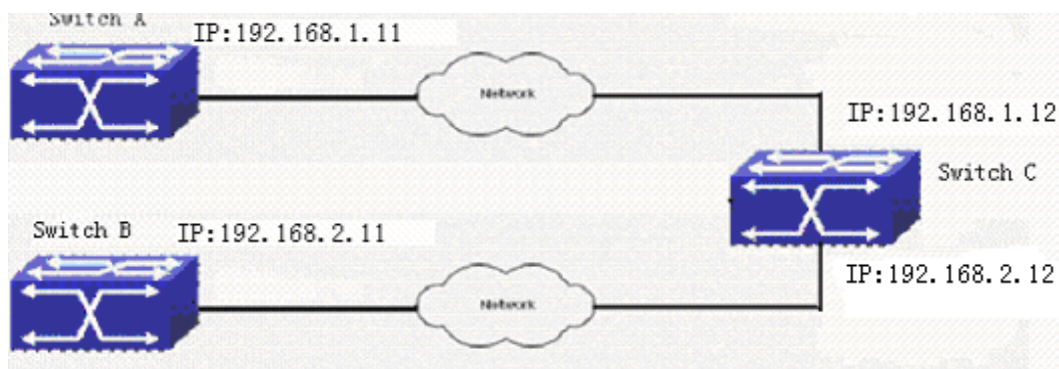

The configuration of Switch C is as follows: (Switch A and Switch B may have the different command because of different companies, we not explain there, our switches are not support NTP server at present)

Switch C:

```
Switch(config)#ntp enable
Switch(config)#interface vlan 1
Switch(Config-if-Vlan1)#ip address 192.168.1.12 255.255.255.0
Switch(config)#interface vlan 2
Switch(Config-if-Vlan1)#ip address 192.168.2.12 255.255.255.0
Switch(config)#ntp server 192.168.1.11
Switch(config)#ntp server 192.168.2.11
```

## 73.4 NTP Function Troubleshooting

In configuration procedures, if there is error occurred, the system can give out the debug information. The NTP function disables by default, the show command can be used to display current configuration. If the configuration is right please use debug every relative debugging command and display specific information in procedure, and the function is configured right or not, you can also use show command to display the NTP running information, any questions please send the recorded message to the technical service center.



---

# Chapter 74 DNSv4/v6 Configuration

## 74.1 Introduction to DNS

DNS (Domain Name System) is a distributed database used by TCP/IP applications to translate domain names into corresponding IPv4/IPv6 addresses. With DNS, you can use easy-to-remember and signification domain names in some applications and let the DNS server translate them into correct IPv4/IPv6 addresses.

There are two types of DNS services, static and dynamic, which supplement each other in application. Each time the DNS server receives a name query it checks its static DNS database first before looking up the dynamic DNS database. Some frequently used addresses can be put in the static DNS database, the reduction the searching time in the dynamic DNS database would increase efficiency. The static domain name resolution means setting up mappings between domain names and IPv4/IPv6 addresses. IPv4/IPv6 addresses of the corresponding domain names can be found in the static DNS database when you use some applications. Dynamic domain name resolution is implemented by querying the DNS server. A user program sends a name query to the resolver in the DNS client when users want to use some applications with domain name, the DNS resolver looks up the local domain name cache for a match. If a match is found, it sends the corresponding IPv4/IPv6 address back to the switch. If no match is found, it sends a query to a higher DNS server. This process continues until a result, whether success or failure, is returned.

The Domain Name System (DNS) is a hierarchical naming system for computers, services, or any resource participating in the Internet. It associates various information with domain names assigned to such participants. Most importantly, it translates humanly meaningful domain names to the numerical (binary) identifiers associated with networking equipment for the purpose of locating and addressing these devices world-wide. An often used analogy to explain the Domain Name System is that it serves as the "phone book" for the Internet by translating human-friendly computer hostnames into IP addresses.

The Domain Name System makes it possible to assign domain names to groups of Internet users in a meaningful way, independent of each user's physical location. Because of this, World-Wide Web (WWW) hyperlinks and Internet contact information can remain consistent and constant even if the current Internet routing arrangements change or the participant uses a mobile device. Internet domain names are easier to remember than IP addresses such as 208.77.188.166(IPv4) or 2001:db8:1f70::999:de8:7648:6e8 (IPv6). People take advantage of this when they recite meaningful URLs and e-mail addresses without having to know how the machine will actually locate them.

The Domain Name System distributes the responsibility for assigning domain names and mapping them to Internet Protocol (IP) networks by designating authoritative name servers for each domain to keep track of their own changes, avoiding the need for a central register to be continually consulted and updated.

In general, the Domain Name System also stores other types of information, such as the list of mail servers that accept email for a given Internet domain. By providing a world-wide, distributed keyword-based redirection service, the Domain Name System is an essential component of the functionality of the Internet.

---

## 74.2 DNSv4/v6 Configuration Task List

1. To enable/disable DNS function
2. To configure/delete DNS server
3. To configure/delete domain name suffix
4. To delete the domain entry of specified address in dynamic cache
5. To enable DNS dynamic domain name resolution
6. Enable/disable DNS SERVER function
7. Configure the max number of client information in the switch queue
8. Configure the timeout value of caching the client information on the switch
9. Monitor and diagnosis of DNS function

### 1. To enable/disable DNS function

Command	Explanation
Global Mode	
<b>ip domain-lookup</b> <b>no ip domain-lookup</b>	To enable/disable DNS dynamic lookup function.

### 2. To configure/delete DNS server

Command	Explanation
Global Mode	
<b>dns-server</b> {<ip-address> / <ipv6-address>} [priority <value>] <b>no dns-server</b> {<ip-address> / <ipv6-address>}	To configure DNS server, the no form of this command deletes DNS server.

### 3. To configure/delete domain name suffix

Command	Explanation
Global Mode	
<b>ip domain-list</b> <WORD> <b>no ip domain-list</b> <WORD>	To configure/delete domain name suffix.

### 4. To delete the domain entry of specified address in dynamic cache

Command	Explanation
Admin Mode	
<b>clear dynamic-host</b> {<ip-address> / <ipv6-address> / all}	To delete the domain entry of specified address in dynamic cache.

---

## 5. To enable DNS dynamic domain name resolution

Command	Explanation
Global Mode	
<b>dns lookup {ipv4   ipv6} &lt;hostname&gt;</b>	To enable DNS dynamic domain name resolution.

## 6. Enable/disable DNS SERVER function

Command	Explanation
Global Mode	
<b>ip dns server</b> <b>no ip dns server</b>	Enable/disable DNS SERVER function.

## 7. Configure the max number of client information in the switch queue

Command	Explanation
Global Mode	
<b>ip dns server queue maximum</b> <b>&lt;1-5000&gt;</b> <b>no ip dns server queue maximum</b>	Configure the max number of client information in the switch queue.

## 8. Configure the timeout value of caching the client information on the switch

Command	Explanation
Global Mode	
<b>ip dns server queue timeout &lt;1-100&gt;</b> <b>no ip dns server queue timeout</b>	Configure the timeout value of caching the client information on the switch.

## 9. Monitor and diagnosis of DNS function

Command	Explanation
Admin Mode and Configuration Mode	
<b>show dns name-server</b>	To show the configured DNS server information.
<b>show dns domain-list</b>	To show the configured DNS domain name suffix information.
<b>show dns hosts</b>	To show the dynamic domain name information of resolved by switch.
<b>show dns config</b>	Display the configured global DNS information on the switch.
<b>show dns client</b>	Display the DNS Client information maintained by the switch.

```

debug dns {all | packet [send | rcv] |
events | relay}
no debug dns {all | packet [send | rcv]
| events | relay}

```

To enable/disable DEBUG of DNS function.

## 74.3 Typical Examples of DNS

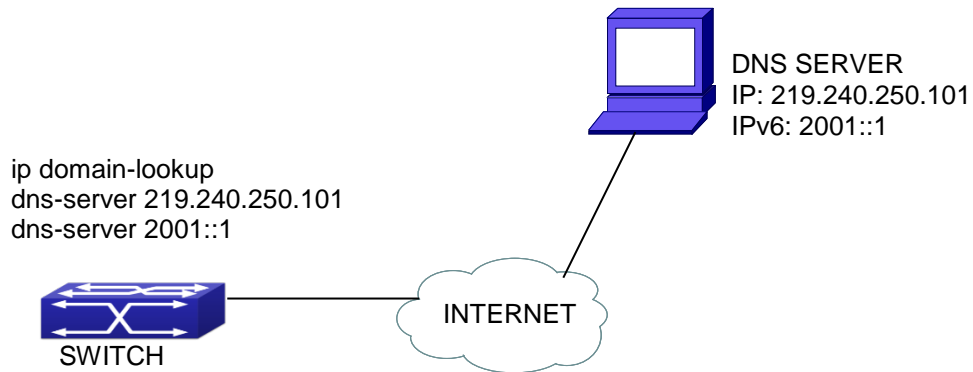

**Figure 74-1** DNS CLIENT typical environment

As shown in fig, the switch connected to DNS server through network, if the switch want to visit sina Website, it needn't to know the IPv4/IPv6 address of sina Website, only need is to record the domain name of sina Website is www.sina.com.cn. The DNS server can resolute out the IPv4/IPv6 address of this domain name and send to switch, then the switch can visit sina Website correctly. The switch is configured as DNS client, basic configurations are as below: first to enable DNS dynamic domain name resolution function on switch, and configure DNS server address, then with some kinds of tools such as PING, the switch can get corresponding IPv4/IPv6 address with dynamic domain name resolution function.

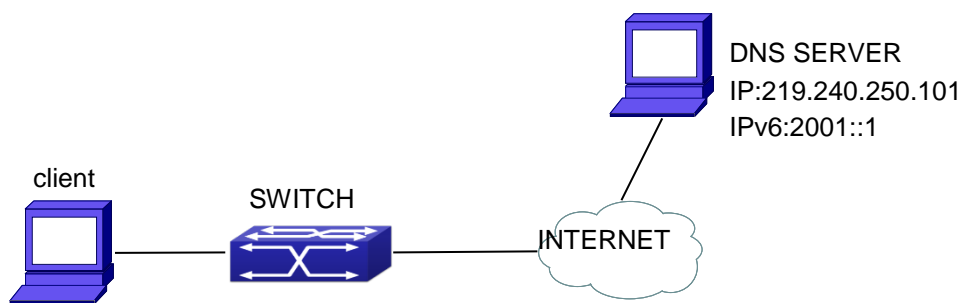

**Figure 74-2** DNS SERVER typical environment

The figure above is an application of DNS SERVER. Under some circumstances, the client PC doesn't know the real DNS SERVER, and points to the switch instead. The switch plays the role of a DNS SERVER in two steps: Enable the global DNS SERVER function, configure the IP address of the real DNS server. After the DNS SERVER function is globally enabled, the switch will look up its local cache when receiving a DNS request from a client PC. If there is a domain needed by the local client, it will directly answer the client's

---

request; otherwise, the switch will relay the request to the real DNS server, pass the reply from the DNS Server to the client and record the domain and its IP address for a faster lookup in the future.

Switch configuration for DNS CLIENT:

```
Switch(config)# ip domain-lookup
Switch(config)# dns-server 219.240.250.101
Switch(config)# dns-server 2001::1
Switch#ping host www.sina.com.cn
Switch#traceroute host www.sina.com.cn
Switch#telnet host www.sina.com.cn
```

Switch configuration for DNS SERVER:

```
Switch(config)# ip domain-lookup
Switch(config)# dns-server 219.240.250.101
Switch(config)# dns-server 2001::1
Switch(config)# ip dns server
```

## 74.4 DNS Troubleshooting

In configuring and using DNS, the DNS may fail due to reasons such as physical connection failure or wrong configurations. The user should ensure the following:

- First make sure good condition of the TACACS+ server physical connection;
- Second all interface and link protocols are in the UP state (use “**show interface**” command);
- Then please make sure that the DNS dynamic lookup function is enabled (use the “ip domain-lookup” command) before enabling the DNS CLIENT function. To use DNS SERVER function, please enable it (use the “ip dns server” command);
- Finally ensure configured DNS server address (use “**dns-server**” command), and the switch can ping DNS server;
- If the DNS problems remain unsolved, please use debug DNS all and other debugging command and copy the DEBUG message within 3 minutes, send the recorded message to the technical service center of our company.

---

# Chapter 75 Summer Time Configuration

## 75.1 Introduction to Summer Time

Summer time is also called daylight saving time, it is a time system for saving energy sources. In summer the time is advanced 1 hour to keep early hours, reduce the lighting, so as to save electrolighting. The rule that adopt summer time is different in each country. At present, almost 110 countries implement summer time.

Compare with the standard time, usually set summer time 1 hour late, for example, when summer time is implementing, 10:00 am of the standard time is considered 11:00 am of summer time.

## 75.2 Summer Time Configuration Task Sequence

1. Configure absolute or recurrent time range of summer time

### 1. Configure absolute or recurrent time range of summer time

Command	Explanation
Global Mode	
<b>clock summer-time &lt;word&gt; absolute &lt;HH:MM&gt; &lt;YYYY.MM.DD&gt; &lt;HH:MM&gt; &lt;YYYY.MM.DD&gt; [&lt;offset&gt;] no clock summer-time</b>	Set absolute time range of summer time, start and end summer time is configured with specified year.
<b>clock summer-time &lt;word&gt; recurring &lt;HH:MM&gt; &lt;MM.DD&gt; &lt;HH:MM&gt; &lt;MM.DD&gt; [&lt;offset&gt;] no clock summer-time</b>	Set recurrent time range of summer time, every year the summer time begins from the start time and end at the end time.
<b>clock summer-time &lt;word&gt; recurring &lt;HH:MM&gt; &lt;week&gt; &lt;day&gt; &lt;month&gt; &lt;HH:MM&gt; &lt;week&gt; &lt;day&gt; &lt;month&gt; [&lt;offset&gt;] no clock summer-time</b>	Set recurrent time range of summer time, every year the summer time begins from the start time and end at the end time.

## 75.3 Examples of Summer Time

Example1:

The configuration requirement in the following: The summer time from 23:00 on April 1st, 2012 to 00:00 on October 1st, 2012, clock offset as 1 hour, and summer time is named as 2012.

---

Configuration procedure is as follows:

```
Switch(config)# clock summer-time 2012 absolute 23:00 2012.4.1 00:00 2012.10.1
```

Example2:

The configuration requirement in the following: The summer time from 23:00 on the first Saturday of April to 00:00 on the last Sunday of October year after year, clock offset as 2 hours, and summer time is named as time\_travel.

Configuration procedure is as follows:

```
Switch(config)#clock summer-time time_travel recurring 23:00 first sat apr 00:00 last sun oct 120
```

## 75.4 Summer Time Troubleshooting

If there is any problem happens when using summer time, please check whether the problem is caused by the following reasons:

- Check whether command mode in global mode
- Check whether system clock is correct

---

# Chapter 76 Monitor and Debug

When the users configures the switch, they will need to verify whether the configurations are correct and the switch is operating as expected, and in network failure, the users will also need to diagnostic the problem. Switch provides various debug commands including ping, telnet, show and debug, etc. to help the users to check system configuration, operating status and locate problem causes.

## 76.1 Ping

Ping command is mainly used for sending ICMP query packet from the switches to remote devices, also for check the accessibility between the switch and the remote device. Refer to the Ping command chapter in the Command Manual for explanations of various parameters and options of the Ping command.

## 76.2 Ping6

Ping6 command is mainly used by the switch to send ICMPv6 query packet to the remote equipment, verifying the accessibility between the switch and the remote equipment. Options and explanations of the parameters of the Ping6 command please refer to Ping6 command chapter in the command manual.

## 76.3 Traceroute

Traceroute command is for testing the gateways through which the data packets travel from the source device to the destination device, so to check the network accessibility and locate the network failure.

Execution procedure of the Traceroute command consists of: first a data packet with TTL at 1 is sent to the destination address, if the first hop returns an ICMP error message to inform this packet can not be sent (due to TTL timeout), a data packet with TTL at 2 will be sent. Also the send hop may be a TTL timeout return, but the procedure will carries on till the data packet is sent to its destination. These procedures is for recording every source address which returned ICMP TTL timeout message, so to describe a path the IP data packets traveled to reach the destination.

Traceroute Options and explanations of the parameters of the Traceroute command please refer to traceroute command chapter in the command manual.

## 76.4 Traceroute6

The Traceroute6 function is used on testing the gateways passed through by the data packets from the source equipment to the destination equipment, to verify the accessibility and locate the network failure. The principle of the Traceroute6 under IPv6 is the same as that under IPv4, which adopts the hop limit field of the ICMPv6 and IPv6 header. First, Traceroute6 sends an IPv6 datagram (including source address, destination



address and packet sent time) whose HOPLIMIT is set to 1. When first route on the path receives this datagram, it minus the HOPLIMIT by 1 and the HOPLIMIT is now 0. So the router will discard this datagram and returns with a 「ICMPv6 time exceeded」 message (including the source address of the IPv6 packet, all content in the IPv6 packet and the IPv6 address of the router). Upon receiving this message, the Traceroute6 sends another datagram of which the HOPLIMIT is increased to 2 so to discover the second router. Plus 1 to the HOPLIMIT every time to discover another router, the Traceroute6 repeat this action till certain datagram reaches the destination.

Traceroute6 Options and explanations of the parameters of the Traceroute6 command please refer to traceroute6 command chapter in the command manual.

## 76.5 Show

**show** command is used to display information about the system , port and protocol operation. This part introduces the **show** command that displays system information, other **show** commands will be discussed in other chapters.

Admin Mode	
<b>show debugging</b>	Display the debugging state.
<b>show flash</b>	Display the files and the sizes saved in the flash.
<b>show history</b>	Display the recent user input history command.
<b>show history all-users [detail]</b>	Show the recent command history of all users. Use <b>clear history all-users</b> command to clear the command history of all users saved by the system, the max history number can be set by <b>history all-users max-length</b> command.
<b>show memory</b>	Display content in specified memory area.
<b>show running-config</b>	Display the switch parameter configuration validating at current operation state.
<b>show startup-config</b>	Display the switch parameter configuration written in the Flash Memory at current operation state, which is normally the configuration file applied in next time the switch starts up.
<b>show switchport interface [ethernet &lt;IFNAME&gt;]</b>	Display the VLAN port mode and the belonging VLAN number of the switch as well as the Trunk port information.
<b>show tcp</b> <b>show tcp ipv6</b>	Display the TCP connection status established currently on the switch.
<b>show udp</b> <b>show udp ipv6</b>	Display the UDP connection status established currently on the switch.
<b>show telnet login</b>	Display the information of the Telnet client which currently establishes a Telnet connection with the switch.

<b>show tech-support</b>	Display the operation information and the state of each task running on the switch. It is used by the technicians to diagnose whether the switch operates properly.
<b>show version</b>	Display the version of the switch.
<b>show temperature</b>	Show CPU temperature of the switch.

## 76.6 Debug

All the protocols switch supports have their corresponding debug commands. The users can use the information from debug commands for troubleshooting. Debug commands for their corresponding protocols will be introduced in the later chapters.

## 76.7 System log

### 76.7.1 System Log Introduction

The system log takes all information output under its control, while making a detailed catalogue, so to select the information effectively. Combining with Debug programs, it will provide a powerful support to the network administrator and developer in monitoring the network operation state and locating the network failures.

The switch system log has the following characteristics:

- Log output from four directions (or log channels) of the Console, Telnet terminal and monitor, log buffer zone, and log host.
- The log information is classified to four levels of severities by which the information will be filtered.
- According to the severity level the log information can be auto outputted to the corresponding log channel.

#### 76.7.1.1 Log Output Channel

So far the system log can be outputted the log information through four channels:

- Through Console port to the local console
- Output the log information to remote Telnet terminal or monitor, this function is good for remote maintenance
- Assign a proper log buffer zone inside the switch, for record the log information permanently or temporarily
- Configure the log host, the log system will directly send the log information to the log host, and save it in files to be viewed at any time

Among the above log channels, users rarely use the console monitor, but will commonly choose the Telnet terminal to monitor the system operation status. However, information outputted from these channels are of low traffic capacity and can not be recorded for later view. The other two channels---the log buffer zone and log host channel are two important channels.

SDRAM (Synchronous Dynamic Random Access Memory) and NVRAM (Non Volatile Random Access Memory) is provided inside the switch as two part of the log buffer zone, The two buffer zone record the log information in a circuit working pattern, namely when log information need to be recorded exceeds the buffer size, the oldest log information will be erased and replaced by the new log information, information saved in NVRAM will stay permanently while those in SDRAM will lost when the system restarts or encounter an power failure. Information in the log buffer zone is critical for monitoring the system operation and detecting abnormal states.

**Note: the NVRAM log buffer may not exist on some switches, which only have the SDRAM log buffer zone.**

**It is recommended to use the system log server. By configuring the log host on the switch, the log can be sent to the log server for future examination.**

### 76.7.1.2 Format and Severity of the Log Information

The log information format is compatible with the BSD syslog protocol, so we can record and analyze the log by the systlog (system log protect session) on the UNIX/LINUX, as well as syslog similar applications on PC.

The log information is classified into eight classes by severity or emergency procedure. One level per value and the higher the emergency level the log information has, the smaller its value will be. For example, the level of critical is 2, and warning is 4, debugging is leveled at 7, so the critical is higher than warnings which no doubt is high than debugging. The rule applied in filtering the log information by severity level is that: only the log information with level equal to or higher than the threshold will be outputted. So when the severity threshold is set to debugging, all information will be outputted and if set to critical, only critical, alerts and emergencies will be outputted.

Follow table summarized the log information severity level and brief description. **Note:** these severity levels are in accordance with the standard UNIX/LINUX syslog.

Table 76-1 Severity of the log76-4information

Severity	Value	Description
emergencies	0	System is unusable
alerts	1	Action must be taken immediately
critical	2	Critical conditions
errors	3	Error conditions
warnings	4	Warning conditions
notifications	5	Normal but significant condition
informational	6	Informational messages
debugging	7	Debug-level messages

Right now the switch can generate information of following four levels

- Restart the switch, mission abnormal, hot plug on the CHASSIS switch chips are classified critical
- Up/down interface, topology change, aggregate port state change of the interface are notifications warnings

- Outputted information from the CLI command is classified informational
- Information from the debugging of CLI command is classified debugging

Log information can be automatically sent to corresponding channels with regard to respective severity levels. Amongst the debugging information can only be sent to the monitor. Those with the Informational level can only be sent to current monitor terminal, such as the information from the Telnet terminal configuration command can only be transmitted to the Telnet terminal. Warnings information can be sent to all terminal with also saved in the SDRAM log buffer zone. And the critical information can be save both in SDRAM and the NVRAM (if exists) besides sent to all terminals. To check the log save in SDRAM and the NVRAM, we can use the show logging buffered command. To clear the log save in NVRAM and SDRAM log buffer zone, we can use the clear logging command.

## 76.7.2 System Log Configuration

System Log Configuration Task Sequence:

1. Display and clear log buffer zone
2. Configure the log host output channel
3. Enable/disable the log executed-commands
4. Display the log source
5. Display executed-commands state

### 1. Display and clear log buffer zone

Command	Description
Admin Mode	
<b>show logging buffered</b> [ level {critical   warnings}   range <begin-index> <end-index>]	Show detailed log information in the log buffer channel.
<b>clear logging</b> {sdram   nvram}	Clear log buffer zone information.

### 2. Configure the log host output channel

Command	Description
Global Mode	
<b>logging</b> {<ipv4-addr>   <ipv6-addr>} [ facility <local-number> ] [level <severity>] <b>no logging</b> {<ipv4-addr>   <ipv6-addr>} [ facility <local-number>]	Enable the output channel of the log host. The “no” form of this command will disable the output at the output channel of the log host.
<b>logging loghost sequence-number</b> <b>no logging loghost sequence-number</b>	Add the loghost sequence-number for the log, the no command does not include the loghost sequence-number.

### 3. Enable/disable the log executed-commands

Command	Description
Global Mode	
<b>logging executed-commands {enable   disable}</b>	Enable or disable the logging executed-commands

### 4. Display the log source

Command	Description
Admin and configuration mode	
<b>show logging source mstp</b>	Show the log information source of MSTP module.

### 5. Display executed-commands state

Command	Description
Admin mode	
<b>show logging executed-commands state</b>	Show the state of logging executed-commands

## 76.7.3 System Log Configuration Example

**Example 1:** When managing VLAN the IPv4 address of the switch is 100.100.100.1, and the IPv4 address of the remote log server is 100.100.100.5. It is required to send the log information with a severity equal to or higher than warnings to this log server and save in the log record equipment local1.

Configuration procedure:

```
Switch(config)#interface vlan 1
Switch(Config-if-Vlan1)# ip address 100.100.100.1 255.255.255.0
Switch(Config-if-Vlan1)#exit
Switch(config)#logging 100.100.100.5 facility local1 level warnings
```

**Example 2:** When managing VLAN the IPv6 address of the switch is 3ffe:506::1, and the IPv4 address of the remote log server is 3ffe:506::4. It is required to send the log information with a severity equal to or higher than critical to this log server and save the log in the record equipment local7.

Configuration procedure

```
Switch(config)#interface vlan 1
Switch(Config-if-Vlan1)#ipv6 address 3ffe:506::1/64
Switch(Config-if-Vlan1)#exit
Switch(config)#logging 3ffe:506::4 facility local7 level critical
```

---

# Chapter 77 Reload Switch after Specified Time

## 77.1 Introduce to Reload Switch after Specified Time

Reload switch after specified time is to reboot the switch without shutdown its power after a specified period of time, usually when updating the switch version. The switch can be rebooted after a period of time instead of immediately after its version being updated successfully.

## 77.2 Reload Switch after Specified Time Task List

### 1. Reload switch after specified time

Command	Explanation
Admin mode	
<b>reload after &lt;HH:MM:SS&gt;</b>	Reload the switch after a specified period of time.
<b>reload cancel</b>	Cancel the specified time period to reload the switch.

---

# Chapter 78 Debugging and Diagnosis for Packets Received and Sent by CPU

## 78.1 Introduction to Debugging and Diagnosis for Packets Received and Sent by CPU

The following commands are used to debug and diagnose the packets received and sent by CPU, and are supposed to be used with the help of the technical support.

## 78.2 Debugging and Diagnosis for Packets Received and Sent by CPU Task List

Command	Explanation
Global Mode	
<b>cpu-rx-ratelimit total &lt;packets&gt;</b> <b>no cpu-rx-ratelimit total</b>	Set the total rate of the CPU receiving packets, the no command sets the total rate of the CPU receiving packets to default.
<b>cpu-rx-ratelimit protocol &lt;protocol-type&gt;</b> <b>&lt;packets&gt;</b> <b>no cpu-rx-ratelimit protocol [ &lt;protocol-type&gt; ]</b>	Set the max rate of the CPU receiving packets of the protocol type, the no command set the max rate to default.
<b>clear cpu-rx-stat protocol [ &lt;protocol-type&gt; ]</b>	Clear the statistics of the CPU received packets of the protocol type.
Admin Mode	
<b>show cpu-rx protocol [ &lt;protocol-type&gt; ]</b>	Show the information of the CPU received packets of the protocol type.
<b>debug driver {receive send} [interface</b> <b>{&lt;interface-name&gt;  all}] [protocol</b> <b>{&lt;protocol-type&gt;  discard  all}][detail]</b>	Turn on the showing of the CPU receiving or sending packet informations.
<b>no debug driver {receive  send}</b>	Turn off the showing of the CPU receiving or sending packet informations.

# Chapter 79 VSF

## 79.1 Overview

### 79.1.1 Introduction of VSF

VSF is using the VSF port to connect several servers and build up a virtual logical facility. The user cans this virtual machine to manage all the physical facilities that link up together.

Traditional district and the data center network is using the multiple layer network topology structure design as shown below in the **Figure 83-1**. The following are the drawbacks of this type of network:

- (1) The network and the server are complicated, thus it will cause the operation efficiency decrease and at higher cost.
- (2) No status internet conk out switch will delay the recover time of application and break out time of operation.
- (3) Low usage of resources will decrease the return of income (ROI) and increase the capital.

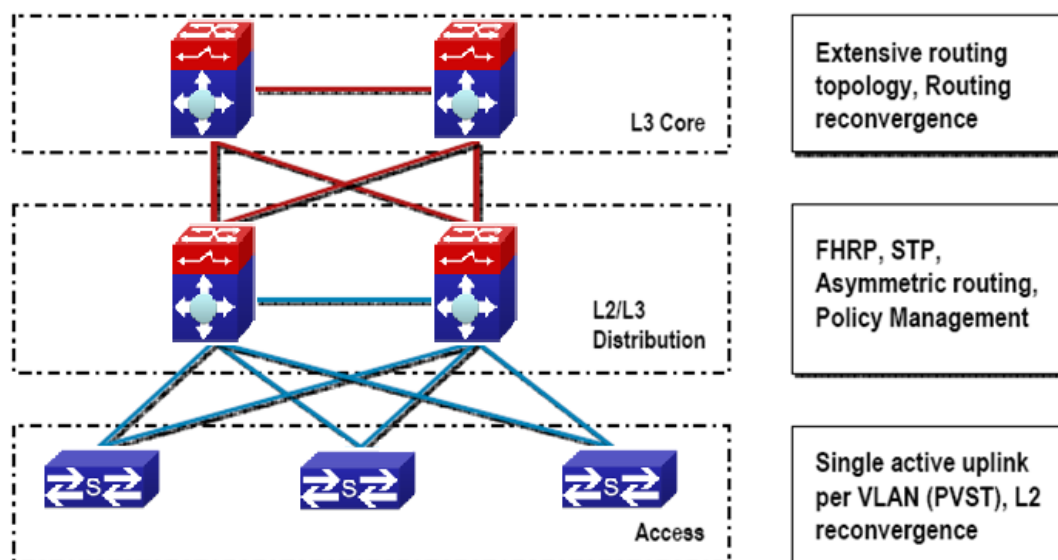

**Figure 83-1:** Traditional Enterprise Network

In order to solving these problems, VSF comes. Make up more than one device which supports VSF to be the single virtualization switch. In VSF, the data panel of the management engine and the exchange array of both switches can be activated at the same time. Members of VSF can throughout the VSL to connection. The VSL standard among the members of the switches is using million-mega Ethernet for connection (maximum have 4 linkages, to provide redundancy), like **Figure 83-2**.



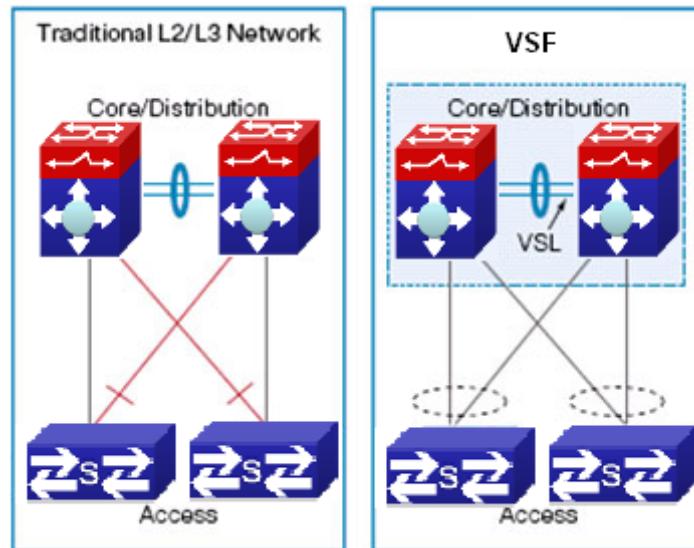

Figure 83-2: VSF

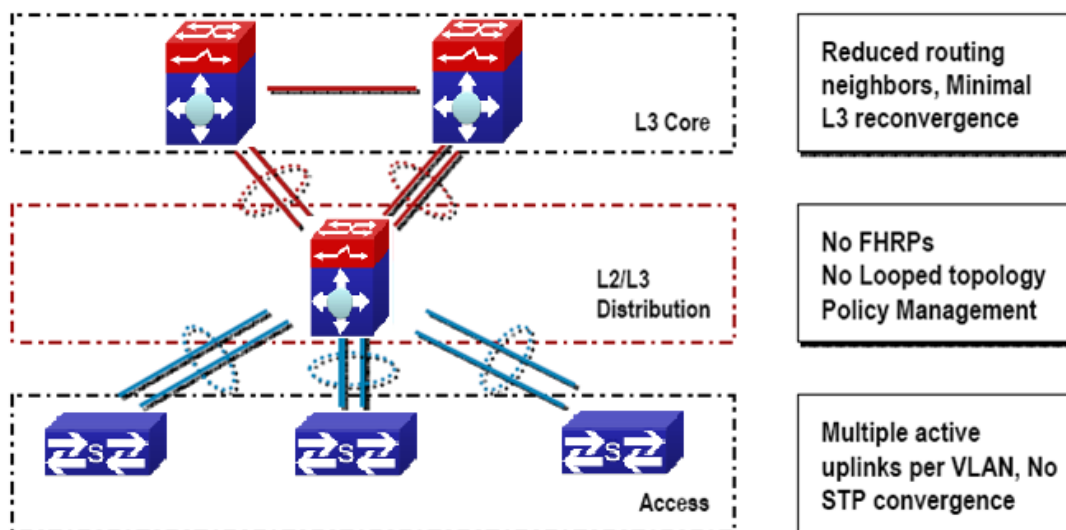

Figure 83-3: Enterprise that adopting virtual technology

Compare with the traditional L2/L3 network design, VSF provides with multiple markedness advantages. All in all, we can conclude with 3 main advantages:

1. VSF can increase the efficiency of operation  
Only one management point, including configuration documents and gateway IP address (dispense with HSRP/ VRRP/GLBP). One logical device which is made up by multiple physical devices creates the simple topology without loop and without the spanning tree protocol (STP). Bottom physical switches connect together by using standard million-mega Ethernet port; it provides a flexible deploy option for the location.
2. VSF can optimize the uninterruptedly communication  
Switches status conk out switching will not interrupt the applications which are using the internet

---

status information. With the help of VSF, if one of the virtual switch members is out of order, no need to continuous the reconstringency of L2/L3 can restart the virtual switch recover in short time.

3. VSF can expand the system bandwidth capacity

In the vsf switch can activate all the L2 bandwidth, can carry on the equilibrium of load on the multiple members of VSF when expanding the bandwidth.

## 79.1.2 Basic Concept

(1) Role

Each of the facilities in the VSF is called member facility. According to the function of each member facility, will divide into 2 different roles:

**Master:** Responds for manage entire VSF

**Standby Master:** Is the standby member of VSF, as the Master backup facility for operation. When the Master is out of order, the systems will handover to Standby Master automatically to perform the original job of Master.

**Slave:** The member facilities that are other than Master and Standby Master in VSF.

Master, Standby Master and Slave are produced by election. For entire VSF, it can only have one Master, one Standby Master, other members should be Slave.

(2) VSF port

It is a logic port which is particular use for VSF. It divides into vsf-port1 and vsf-port2, need to colligate with the VSF physical port and then become effictive.

(3) VSF physical port

It is the facility that is used for physical connection port for VSF. VSF physical port can be VSF specific port, Ethernet port or light port (different equipment and the model will using different port, please equipt it according to the virtual situtation). Usually, Ethernet port and light port respond for transmitting operation message. After they colligate with the VSF port, they will become the VSF physical port. They will use for transmitting the message within the members. The message including VSF related negotiation message and the operation message that needs to cross over different members.

(4) Merge

Two different VSF operation separately, throughout the physical connection and configuration, it will become one VSF. This process is called merge.

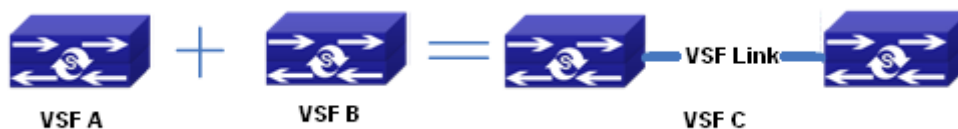

Figure 83-4: Merging of VSF

(5) Split

One VSF is formed. Due to the VSF link is out of order, it will cause the facilities that are border upon

cannot connect together physically. Therefore, one stracking will divide into two stracking. This process is called split.



**Figure 83-5:** Splitting of tacking

(6) Priority of member

Priority of member is the member facilities attribute, mainly use for the role selection for confirming the role of each members. If the facility has higher the priority, it will have higher chance to become the Master. The default setting of the facilities is 1. If the user want to pre-set particular facility become the Master, he can increase the priority value of that facility manually before build up the VSF.

### 79.1.3 Glossary

**VSF** is the short form of the Virtual Switching Framework.

**VSF Port:** VSF port, is a mode on port-channel

**VSF AM:** the master card of the VSF activities

**VSF SM:** the backup master card of the VSF activities

**VSF Slave:** the slave card of VSF, to operate the VSF agreement ,during the switching it means Chassis AM , the not selecte one is VSF AM or VSF SM

**VSF Member:** the member facilities of VSF

**VSF Master Member:** the master member facility of VSF

**VSF Standby Master Member:** the standby master member facility of VSF

**VSF Slave Member:** the slave member facilities of VSF

**HA:** High Availability

**AM:** Active Master, activities controller. It is the switch whose working mode is Master is and it is in the operation status, each of the cassette vsf group can only has a AM at each time.

**SM :** Standby Master, the working mode in the cassette vsf group is Master and it locates in the standby status.

**SSO:** Stateful Switchove, the data of in-phase agreement layer will occur the switchover, the backup master agreement apply function which can connect to corresponding function fleetly. The data of this function will not be lose, but the router agreement data is not in-phase

**NSF:** None Stop Forwarding. Using the independent management characteristics of data layer control, data layer can still transmit data normally as the control layer is out of order

**NSF/SSO:** Nonstop Forwarding with Stateful Switchover means that undergo the SSO “master-backup interchange” , the data transmit is not affected

**Syn process :** HA synchronization processes responsible for activities control and backup agreement function collection or distribution and data synchronization communication.

**GR:** Graceful restart. In order to transmitting uninterruptedly, require the router confer to extend to support the GR ability.

**MAD:** Multi-Active Detection

### 79.1.4 VSF Typical Application

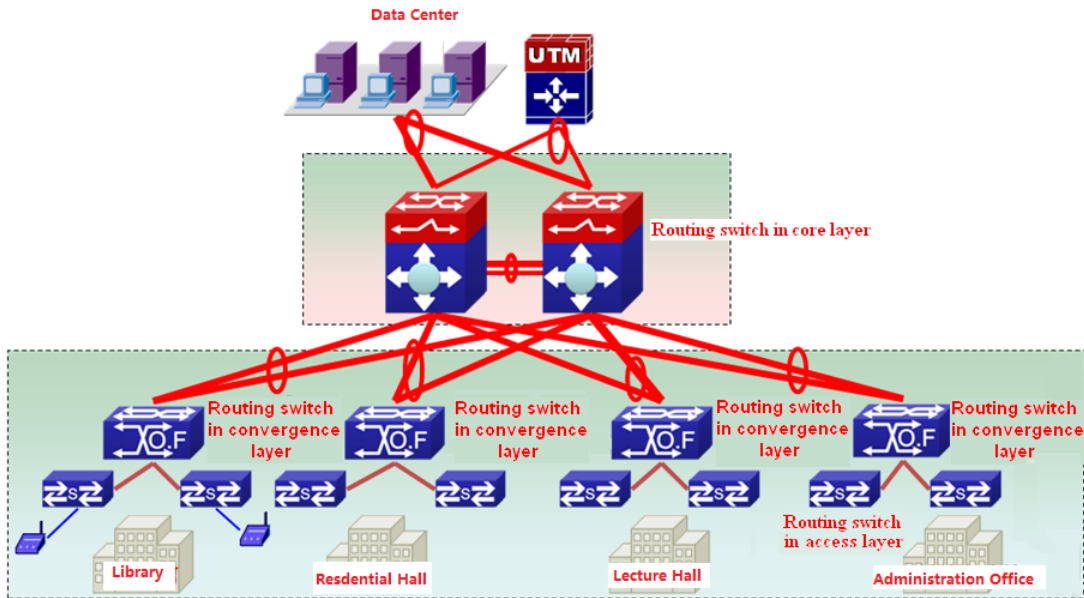

**Figure 83-6:** application of VSF in the campus data center

**Figure 83-6** is the application of VSF in the campus internet. After using the VSF, it groups several facilities together to become the single logic facility and connect to the virtual facility. After the predigestion, the network do not need to use MSTP, VRRP protocol, it simplifies the network configuration. At the same time, it relies on the cross facilities to aggregate the link. When some of the members are out of order, it will not rely on MSTP, VRRP protocol etc constringency, thus in increase the reliability.

### 79.1.5 LACP MAD

lacp mad is the dynamic aggregation method based on lacp. Each member device of vsf has one port connecting to the middle device at least.

Notice: The middle device must be the device which supports the extended function of lacp.

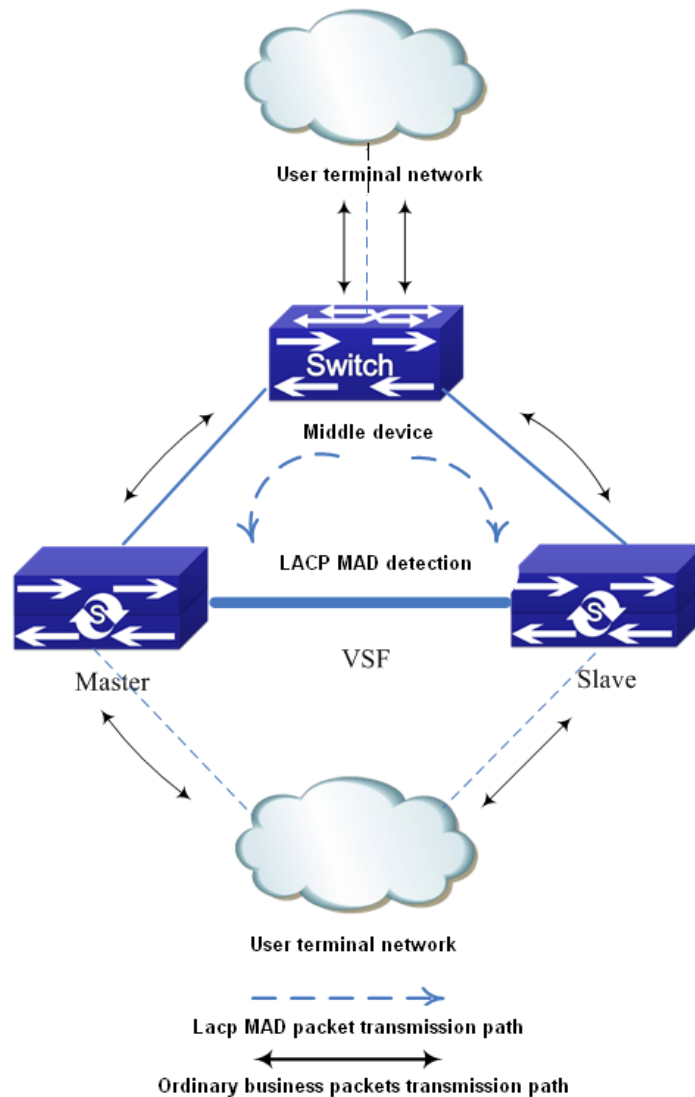

**Figure 83-7: LACP MAD detection**

LACP MAD detection is achieved through the extended LACP protocol packets content. It defines a new TLV (Type Length Value) in the extended field of LACP protocol packets and this TLV is used for the ActiveID of the interaction VSF. For VSF system, ActiveID value is unique, and it is expressed by the member number of the master device in VSF. After enabling LACP MAD detection, the member device interact the ActiveID information with other member devices through the LACP protocol packets.

When VSF is running normally, the ActiveID values of the LACP protocol packets sent by all member devices are the same, there is no Active conflict.

When the VSF is split into two vsf, the ActiveID values of the LACP protocol packets sent by different VSF member devices are the different and multiple Active conflict will be detected.

## 79.1.6 BFD MAD

The topology of Bfd mad detection is simpler then lacp. But, one vlan is selected for bfd mad detection once, this vlan and the ports in it will be as the specific vlan and ports of bfd mad and they cannot be configured other functions.

Construction method: select one port on member1 and select one port on member2. Connect them with a line.

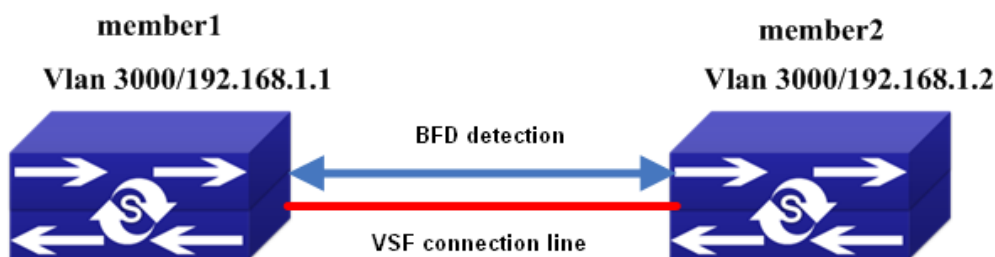

**Figure 83-8:** BFD MAD detection

BFD MAD detection is achieved through BFD protocol. For BFD MAD detection function running normally, enable BFD MAD detection function under the layer3 interface and configure MAD IP address on this interface. The difference between MAD IP address and the ordinary IP address is that MAD IP address is bond to the member device, each member device in VSF should configured it and they must belong to the same network segment.

When VSF is running normally, only the MAD IP address configured on master is effective, the MAD IP associated with the slave device is not effective, BFD session is under the status of down.

When the VSF is split into two vsf, the mad ip address associated with the member on the new vsf becomes effective. Through the connection line of bfd mad detection, the bfd session will be created between the two vsf to detect the multiple Active conflict.

## 79.2 Relevant VSF Configuration

### 79.2.1 VSF Configuration

#### VSF configuration task list:

1. Configure the number of VSF members (necessary)
2. Configure the priority of VSF members (optional)
3. Configure the VSF domain (optional)
4. Configure the logic VSF port  
Configure the logic VSF port  
Bind the physical port to the logic port
5. Transform the device from independent operation mode to VSF operation mode
6. Configure the VSF to merge automatically (optional)
7. Describe the VSF members (optional)
8. Configure the down delaying reporting function of the VSF link (optional)
9. Configure the keeping time of MAC address of VSF group after VSF split (optional)
10. Transform the device from VSF operation mode to the independent operation mode
11. Detect the VSF link status' change quickly

**Configure the number of VSF members (necessary)**

Command	Explanation
Global Mode	
<b>vsf member &lt;member-id&gt;</b> <b>no vsf member &lt;member-id&gt;</b>	Configure/delete the number of VSF members.

**Configure the priority and domain of VSF members (optional)**

Command	Explanation
Global Mode	
<b>vsf priority &lt;priority&gt;</b> <b>no vsf priority</b>	Configure/delete the priority of VSF members.
<b>vsf domain &lt;domain-id&gt;</b> <b>no vsf domain</b>	Configure/delete the VSF domain, the no command recovers to be default of 1.

**Configure the logic VSF port and Bind the physical port to the logic port**

Command	Explanation
Global Mode	
<b>vsf port-group &lt;port-number&gt;</b> <b>no vsf port-group &lt;port-number&gt;</b>	Configure/delete the logic VSF port.
VSF Port Configuration Mode	
<b>vsf port-group interface Ethernet &lt;interface-list&gt;</b> <b>no vsf port-group interface Ethernet &lt;interface-list&gt;</b>	Bind the physical port to the logic VSF port or delete the binding.

**Transform the operation modes of the device**

Command	Explanation
Global Mode	
<b>switch convert mode ( stand-alone   vsf )</b>	Transform the device from independent operation mode to VSF operation mode or transform the device from VSF operation mode to the independent operation mode

**Other configurations**

Command	Explanation
Global Mode	
<b>vsf auto-merge enable</b> <b>no vsf auto-merge enable</b>	Enable the automatic merger function of VSF, the no command disables this function.

<b>vsf member &lt;member-id&gt; description</b> <b>&lt;text&gt;</b> <b>no vsf member &lt;member-id&gt;</b> <b>description</b>	Describe the VSF members. This information will be only written in the VSF master configuration file. The no command deletes this information.
<b>vsf link delay&lt;interval&gt;</b> <b>no vsf link delay</b>	Configure the down delaying reporting function of the VSF link, using for avoid link to split and merge due to changing in short period of time. The <b>no</b> command will set the time for delay report to default value.
<b>vsf mac-address persistent &lt;timer  </b> <b>always&gt;</b> <b>no vsf mac-address persistent</b>	Configure VSF split group MAC address retention time. <b>No</b> command deletes the MAC address retention time.
<b>vsf non-wait port-inactive</b> <b>no vsf non-wait port-inactive</b>	Detect the VSF link status' change quickly for discovering the vsf splitting. The <b>no</b> command recovers to be the default method.

## 79.2.2 LACP MAD Configuration

LACP MAD configuration task list:

1. Create the aggregation groups
2. Add the port into the aggregation group, and one is with the active method at least
3. Configure the quick detection (optional)
4. Enable LACP MAD

### 1. Create the aggregation groups

Command	Explanation
Global Mode	
<b>port-group &lt;port-group id&gt;</b> <b>no Port-group &lt;port-group id&gt;</b>	Create/delete the port-group.

### 2. Add the port into the aggregation group

Command	Explanation
Global Mode	
<b>interface ethernet &lt;port-num&gt;</b>	Enter into the port mode.
Port Mode	
<b>port-group &lt;port-group id&gt; mode</b> <b>&lt;active   passive&gt;</b> <b>no port-group &lt;port-group id&gt;</b>	Add the port into the aggregation group or let it quit.



### 3. Configure the quick detection

Command	Explanation
Port Mode	
<b>lACP timeout &lt;long / short&gt;</b> <b>no lACP timeout</b>	Configure/delete the quick detection.

### 4. Enable LACP MAD

Command	Explanation
Aggregation Port Mode	
<b>vsf mad lACP &lt;enable / disable&gt;</b>	Enable/disable LACP MAD on port-group.

## 79.2.3 BFD MAD Configuration

### BFD MAD configuration task list:

1. Create the vlan used for BFD MAD
2. Add the port used for BFD MAD into the corresponding vlan
3. Configure IP address for BFD MAD layer3 interface
4. Enable BFD MAD function

#### 1. Create the vlan used for BFD MAD

Command	Explanation
Global Mode	
<b>vlan &lt;vlan-id&gt;</b> <b>no vlan &lt;vlan-id&gt;</b>	Configure/delete vlan.

#### 2. Add the port used for BFD MAD into the corresponding vlan

Command	Explanation
VLAN Configuration Mode	
<b>switchport interface ethernet</b> <b>&lt;port-num&gt;</b> <b>no switchport interface ethernet</b> <b>&lt;port-num&gt;</b>	Add the port into vlan or let it out.

#### 3. Configure IP address for BFD MAD layer3 interface

Command	Explanation
Global Mode	
<b>Interface vlan &lt;vlan-id&gt;</b>	Enter into the vlan interface configuration mode.
Interface Configuration Mode	

<b>vsf mad ip address &lt;ip-addr&gt;</b> <b>&lt;ip-mask&gt; member &lt;member-id&gt;</b> <b>no vsf mad ip address &lt;ip-addr&gt;</b> <b>&lt;ip-mask&gt; member &lt;member-id&gt;</b>	Configure/delete the IP address used for BFD MAD on the layer3 interface.
---	---

#### 4. Enable BFD MAD function

Command	Explanation
Interface Configuration Mode	
<b>vsf mad bfd &lt;enable / disable&gt;</b>	Enable/disable BFD MAD.

## 79.3 Typical VSF Example

### Case 1:

Configure under the independent operation mode, let two switches create VSF. The member number of these two facilities is 1 and 2. In order to let vsf member2 as the vsf master, configure the priority of member 2 as 32, and build up two vsf port-group between both facilities. Each of the vsf port-group will colligate one of the million mega port.

### Switch1 VSF configuration as following :

```
Switch1 (config)# config
Switch1 (config)# vsf member 1
Switch1 (config)# vsf port-group 1
Switch1 (config-vsf-port1)# vsf port-group interface ethernet 1/1
Switch1 (config)#vsf port-group 2
Switch1 (config-vsf-port1)#vsf port-group interface ethernet 1/2
Switch1 (config)#exit
Switch1 (config)#switch convert mode vsf
```

### Switch2 VSF configuration as following :

```
Switch2 (config)# config
Switch2 (config)# vsf member 2
Switch2(config)#vsf priority 32
Switch2 (config)# vsf port-group 1
Switch2 (config-vsf-port1)# vsf port-group interface ethernet 2/1
Switch2 (config)#vsf port-group 2
Switch2 (config-vsf-port1)#vsf port-group interface ethernet 2/2
Switch2 (config)#exit
Switch2 (config)#switch convert mode vsf
```

Case 2:

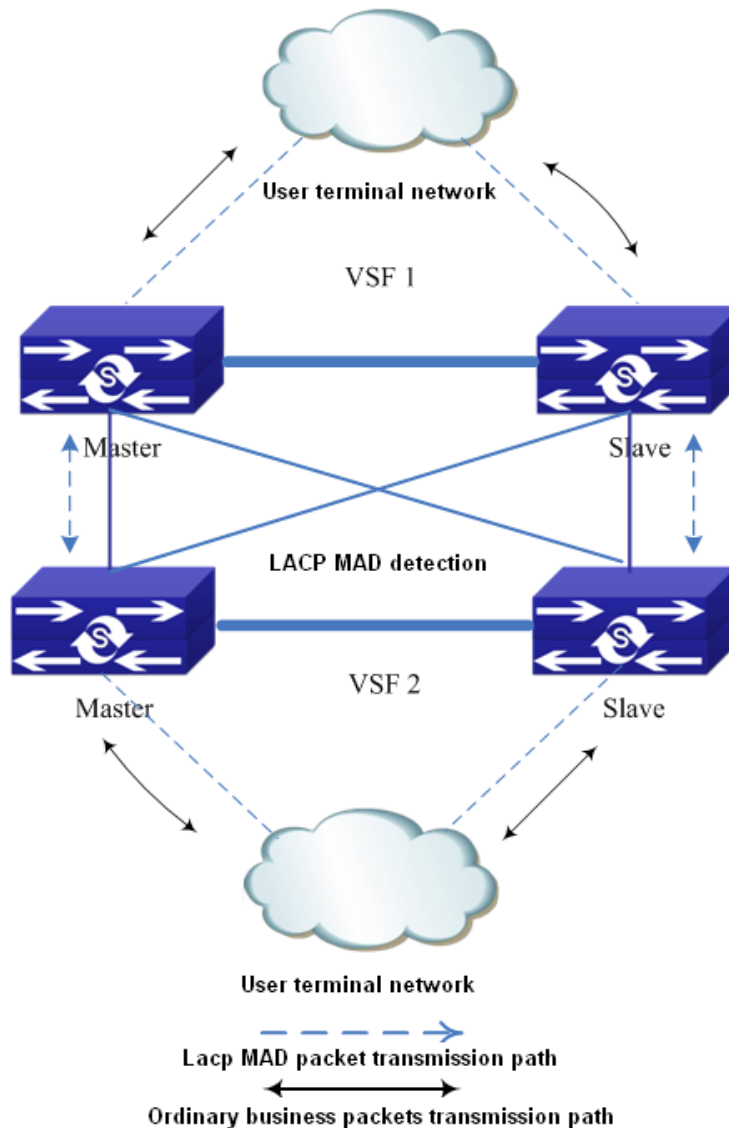

**Figure 83-9:** lacp mad detection topology

As shown in the above picture, use the lacp mad detection function between two vsf. Vsf1 and vsf2 are the devices which are detected and they are also the middle devices. The configuration is same with above. Proposal: uses create the overlapping connection among the devices to avoid that the vsf1 cannot be the middle device to detect vsf2 after it is split.

Assume that vsf1 and vsf2 use the lacp ports of ethernet1/1/1, ethernet 1/1/2, ethernet 2/1/1 and ethernet 2/1/2.

**vsf1 configuration:**

```
Switch (config)# vsf domain 1
```

Configure vsf domain number, it can be configured as other value but it cannot be the same as vsf2.

```
Switch (config)# port-group 1
```

```
Switch (config)# interface ethernet 1/1/1
```

```
Switch (config-if-ethernet1/1/1)# port-group 1 mode active
```

```

Switch (config)# interface ethernet 1/1/2
Switch (config-if-ethernet1/1/2)# port-group 1 mode active
Switch (config)# interface ethernet 2/1/1
Switch (config-if-ethernet2/1/1)# port-group 1 mode active
Switch (config)# interface ethernet 2/1/2
Switch (config-if-ethernet2/1/2)# port-group 1 mode active
Switch (config)# interface ethernet 2/1/1
Switch (config-if-ethernet2/1/2)# interface port-channel 1
Switch (config-if-port-channel1)# vsf mad lacp enable

```

### Vsf2 configuration:

```
Switch (config)# vsf domain 2
```

Configure vsf domain number, it can be configured as other value but it cannot be the same as vsf1.  
Other configuration is same as the configuration on vsf1.

### Case 3 :

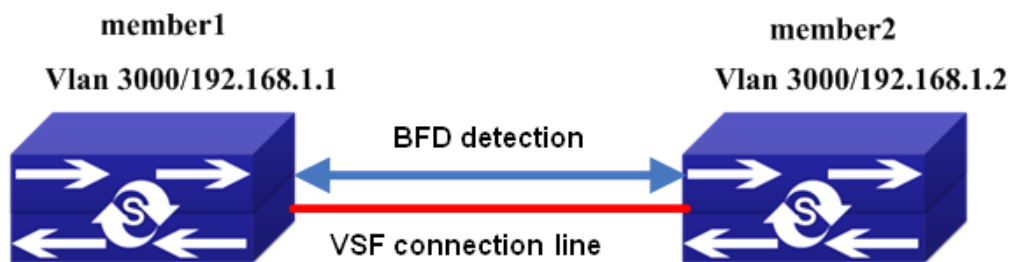

As show in the above picture, assume the ports used for bfd mad detection are ethernet1/1/1 and ethernet2/1/1, and the vlan is 3000. The configuration of mad ip address is the network segment of 192.168.1.1 for example.

### BFD MAD configuration of switch:

```

Switch (config)# vlan 3000
Switch (config-vlan3000)# interface ethernet 1/1/1/
Switch (config-if-ethernet1/1/1)# switchport access vlan 3000
Switch (config-if-ethernet1/1/1)# interface ethernet 2/1/1
Switch (config-if-ethernet2/1/1)# switchport access vlan 3000
Switch (config-if-ethernet2/1/1)# interface vlan 3000
Switch (config-if-vlan3000)# vsf mad bfd enable
Switch (config-if-vlan3000)# vsf mad ip add 192.168.1.1 255.255.255.0 member 2
Switch (config-if-vlan3000)# vsf mad ip add 192.168.1.2 255.255.255.0 member 1

```

Notice: In this time, the whole vsf is a device, so BFD MAD configuration is equivalent to conduct on one device.

---

## 79.4 VSF Troubleshooting

**For VSF, under the configuration and usage, the command may not be workable, please pay attention to the following items:**

- Whether it is at the operation mode, because some of the commands can only be configured at VSF operation mode, but some of them can operation at both VSF and independent operation mode.

Under the failure of VSF during the VSF processes, or appear any abnormality, please pay attention to the following thing:

- First, need to check whether physical connection is correct. Right now, the group VSF machine can only support million-mega port or logic port colligate. Please check whether the colligate port is the million-mega port.
- Whether the Vsf member id is clash, if the member ids are clashing, the facilities cannot form vsf.
- Whether the Vsf domain numbers are same. Only the vsf domain numbers are identical, the facilities can form the vsf.
- To see whether the logical port has any physical connection, for example, double speed, bandwidth restriction, safety authentication, ACL etc configuration.

Under the VSF operation mode to undergo configuration, please pay attention to the following things:

- During the VSF operation mode, VSF related configuration can be done on the each member separately. However, the configuration done on the members cannot be saved independently. It cans still excute the write function on the vsf master. All the membes' personal configuration that is related to vsf will be save in the main computer's vsf.cfg.
- Under the VSF operation mode, some of the commands such as VSF domain number, priority of member, member id etc can still be configured or amended. After the configuration, the show run displays as the latest value, it can only be effective as you restart the computer after saving.

**For LACP MAD, under the configuration and usage, if there are problems, please pay attention to the following items:**

- When creating the aggregation group, the aggregation of the device which is detected and the middle device must be identical.
- The ports of the device which is detected and the middle device cannot be added into the aggregation with on mode for LACP MAD, one should be active method at least.
- When the device which is detected and the middle device are both vsf, the domain id (vsf domain number) of the two vsf cannot be the same.

**For BFD MAD, under the configuration and usage, if there are problems, please pay attention to the following items:**

- bfd mad function cannot be enabled under interface vlan 1.
- bfd mad function and the anti-ring function are mutually exclusive (such as stp, mstp, etc). if this vsf is configured anti-ring function, the ports used for bfd mad detection should be disabled the anti-ring function, otherwise, the detection may fail.
- If there is port configured as truck port on this vsf (include port-channel port), please ensure

---

whether the vlan used for bfd mad detection is in this trunk (trunk port belongs to all vlan as default). If it is in, the vlan used for bfd mad detection must be filtered under this port, otherwise, the loop may appears.

- If there is port configured as hybrid port on this vsf, please ensure that this hybrid port does not belong the vlan used for bfd mad detection, otherwise, the loop may appears.
- The vlan interface and all the ports in this vlan used for bfd mad detection cannot be configured other configuration except bfd mad detection.
- If the bfd mad function will not be used any more, clear the configuration and the connection line used for bfd mad should be removed.
- If bfd mad configuration has been already completed, and other ports, vlan or the command under the global mode should be modified, please ensure whether it conforms the above items.
- Suggestion: user should select a vlan which is not used in business on the whole as the specific vlan for bfd mad detection.

---

# Chapter 80 PoE Configuration

## 80.1 Introduction to PoE

PoE (Power over Ethernet) is a technology to provide direct currents for some IP-based terminals (such as IP phones, APs of wireless LANs and network cameras) while transmitting data to them. Such DC-receiving devices are called PD (Powered Device). The max distance of reliable power supply provided by PoE is 100 meters.

IEEE 802.3af standard is a new PoE standard, and an extension to the current Ethernet standard by adding new items on power supply via network cables to IEEE 802.3 standard. It is also the first international standard on power distribution. IEEE 802.3at standard is the upgraded version of IEEE 802.3af, the maximum power of each port is 30W. It can meet the requirements of the higher power from PD device.

The application of PoE used to be in two areas: IP phone and 802.11 wireless network, however, along with the development of this technology, many applications with more practical meanings have emerged and benefited from PoE, such as video monitoring, integrated building management solution, and remote video service booth. All these existing and predictably more of such applications arouse needs for switches supporting PoE.

## 80.2 PoE Configuration

### The PoE Configuration Task List:

1. Globally enable or disable PoE
2. Globally Set the Max Output Power
3. Globally set power management mode
4. Globally set non-standard PD detection mode
5. Globally enable or disable the allowed high-inrush current when nonstandard PD is powered instantaneously
6. Enable or disable PoE on specified ports
7. Set the max output power on specified ports
8. Set the power priority on specified ports

### 1. Globally Enable or Disable PoE

Command	Explanation
Global Mode	
<b>power inline enable</b> <b>no power inline enable</b>	Enable/disable PoE globally.

## 2. Globally set the max output power

Command	Explanation
Global Mode	
<b>power inline max &lt;max-wattage&gt;</b> <b>no power inline max</b>	Globally set the max output power of PoE.

## 3. Globally set the power management mode

Command	Explanation
Global Mode	
<b>power inline police enable</b> <b>no power inline police enable</b>	Enable/disable the power priority management policy mode.

## 4. Globally set non-standard PD detection mode

Command	Explanation
Global Mode	
<b>power inline legacy enable</b> <b>no power inline legacy enable</b>	Set whether or not to provide power for non-standard IEEE PD.

## 5. Globally enable or disable the allowed high-inrush current when nonstandard PD is powered instantaneously

Command	Explanation
Global Mode	
<b>power inline high-inrush enable</b> <b>no power inline high-inrush enable</b>	Enable/disable the allowed high-inrush current when nonstandard PD is powered instantaneously.

## 6. Enable or disable PoE on specified ports

Command	Explanation
Port Mode	
<b>power inline enable</b> <b>no power inline enable</b>	Enable/ disable PoE.

## 7. Set the max output power on specified ports

Command	Explanation
Port Mode	
<b>power inline max &lt;max-wattage&gt;</b> <b>no power inline max</b>	Set the max output power on specified ports.



## 8. Set the power priority on specified ports

Command	Explanation
Port Mode	
<b>power inline priority {critical   high   low}</b>	Set the power priority on specified ports.

## 80.3 Typical Application of PoE

### Requirements of Network Deployment

Set the max output power of DCRS-5960-28T-POE to 370W, assuming that the default max power can satisfy the requirements.

Ethernet interface 1/0/2 is connected to an IP phone.

Ethernet interface 1/0/4 is connected to a wireless AP.

Ethernet interface 1/0/6 is connected to a Bluetooth AP.

Ethernet interface 1/0/8 is connected to a network camera.

The IP phone connected to Ethernet interface has the highest-level power supply priority: critical, which requires the power supply to the newly connected PD being cut off if it causes PSE power-overload (i.e. adopting the priority policy of PD power management).

Power of subordinate AP devices connected to Ethernet interface 1/0/6 should not exceeds 9000mW.

### Topology of Network

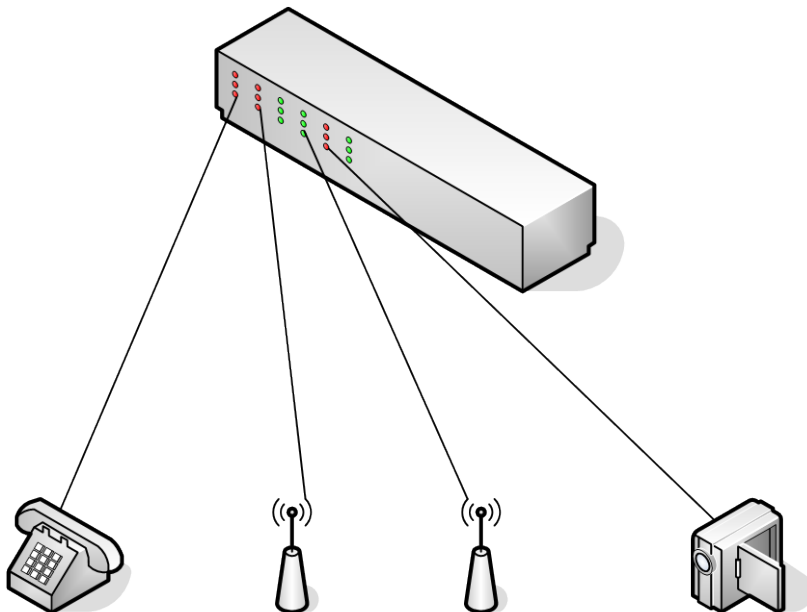

Configuration Steps:

Globally enable PoE:

```
Switch(Config)# power inline enable
```

Globally set the max power to 370W:

```
Switch(Config)# power inline max 370
```

Globally enable the priority policy of power management:

```
Switch(Config)# power inline police enable
```

Set the priority of Port 1/0/2 to critical:

```
Switch(Config-Ethernet1/0/2)# power inline priority critical
```

Set the max output power of Port 1/0/6 to 9000mW:

```
Switch(Config-Ethernet1/0/6)#power inline max 9000
```

## 80.4 PoE Troubleshooting Help

If problems occur on using PoE, please check:

When the global value of Power Remaining is less than 15W, due to the power source protection mechanism, the power supply to new PDs will be cut off in first-come-first-serve mode, while the existing low-priority devices will also be disconnected in priority policy mode. If the Power Remaining is over 15W, say 16W, any newly connected device with a power no more than 15W can get its power supply normally, without affecting other devices. Such a power supply buffer of 15W is designed for power source protection, and calls for special attention.

The displayed value of Power might over the value of Max. This involves the relationship between the displayed power and the actual power, for instance:

The power set on the port: A, represents the actual output PoE power

The displayed power: B, represents the total power of the port (total current × total voltage)

The power loss set on the port: C, represents power loss of the internal Sensor ohmic resistance, MosFet etc.

Then:  $B=A+C$

If the power is set as  $A=500\text{mW}$ , according to the following table, the compensating current will be  $I=2.44\text{mA}$  ( $500\text{mW}/50\text{V}=10\text{mA}$  assuming the current working voltage is 50V), plus the compensating power  $C=50\text{V}\times 2.44\text{mA}=122\text{mW}$

$B=A+C=500+122=622\text{mW}$ . So, only when the displayed power reaches 622mW, the PD will be disconnected

Table:

Max Working Current (mA)	Compensating Current (mA)
50	2.44
100	4.88
150	9.76
200	17.08
250	24.41
350	31.73

---

# Chapter 81 SWITCH OPERATION

## 81.1 Address Table

The Switch is implemented with an address table. This address table composed of many entries. Each entry is used to store the address information of some node in network, including MAC address, port no, etc. This information comes from the learning process of Ethernet Switch.

## 81.2 Learning

When one packet comes in from any port, the Switch will record the source address, port no. And the other related information in address table. This information will be used to decide either forwarding or filtering for future packets.

## 81.3 Forwarding & Filtering

When one packet comes from some port of the Ethernet Switching, it will also check the destination address besides the source address learning. The Ethernet Switching will lookup the address-table for the destination address. If not found, this packet will be forwarded to all the other ports except the port, which this packet comes in. And these ports will transmit this packet to the network it connected. If found, and the destination address is located at different port from this packet comes in, the Ethernet Switching will forward this packet to the port where this destination address is located according to the information from address table. But, if the destination address is located at the same port with this packet comes in, then this packet will be filtered. Thereby increasing the network throughput and availability

## 81.4 Store-and-Forward

Store-and-Forward is one type of packet-forwarding techniques. A Store-and-Forward Ethernet Switching stores the incoming frame in an internal buffer, do the complete error checking before transmission. Therefore, no error packets occurrence, it is the best choice when a network needs efficiency and stability.

The Ethernet Switch scans the destination address from the packet-header, searches the routing table provided for the incoming port and forwards the packet, only if required. The fast forwarding makes the switch attractive for connecting servers directly to the network, thereby increasing throughput and availability. However, the switch is most commonly used to segment existence hubs, which nearly always improves overall performance. An Ethernet Switching can be easily configured in any Ethernet network environment to significantly boost bandwidth using conventional cabling and adapters.

Due to the learning function of the Ethernet switching, the source address and corresponding port number of each incoming and outgoing packet are stored in a routing table. This information is subsequently used to filter packets whose destination address is on the same segment as the source address. This confines network traffic to its respective domain and reduce the overall load on the network.

---

The Switch performs "Store and forward" therefore, no error packets occur. More reliably, it reduces the re-transmission rate. No packet loss will occur.

## 81.5 Auto-Negotiation

The STP ports on the Switch have built-in "Auto-negotiation". This technology automatically sets the best possible bandwidth when a connection is established with another network device (usually at Power On or Reset). This is done by detect the modes and speeds at the second of both device is connected and capable of, both 10BASE-T and 100BASE-TX devices can connect with the port in either Half- or Full-Duplex mode.

<b>If attached device is:</b>	<b>100BASE-TX port will set to:</b>
10Mbps, no auto-negotiation	10Mbps.
10Mbps, with auto-negotiation	10/20Mbps (10BASE-T/Full-Duplex)
100Mbps, no auto-negotiation	100Mbps
100Mbps, with auto-negotiation	100/200Mbps (100BASE-TX/Full-Duplex)

## Chapter 82 TROUBLESHOOTING

This chapter contains information to help you solve problems. If the Ethernet Switch is not functioning properly, make sure the Ethernet Switch was set up according to instructions in this manual.

### **The Link LED is not lit**

#### **Solution:**

Check the cable connection and remove duplex mode of the Ethernet Switch

### **Some stations cannot talk to other stations located on the other port**

#### **Solution:**

Please check the VLAN settings, trunk settings, or port enabled/disabled status.

### **Performance is bad**

#### **Solution:**

Check the full duplex status of the Ethernet Switch. If the Ethernet Switch is set to full duplex and the partner is set to half duplex, then the performance will be poor. Please also check the in/out rate of the port.

### **Why the Switch doesn't connect to the network**

#### **Solution:**

- Check the LNK/ACT LED on the switch
- Try another port on the Switch
- Make sure the cable is installed properly
- Make sure the cable is the right type
- Turn off the power. After a while, turn on power again

# Chapter 83 APPENDIX A

## 83.1 A.1 Switch's RJ45 Pin Assignments

1000Mbps, 1000BASE T

Contact	MDI	MDI-X
1	BI_DA+	BI_DB+
2	BI_DA-	BI_DB-
3	BI_DB+	BI_DA+
4	BI_DC+	BI_DD+
5	BI_DC-	BI_DD-
6	BI_DB-	BI_DA-
7	BI_DD+	BI_DC+
8	BI_DD-	BI_DC-

Implicit implementation of the crossover function within a twisted-pair cable, or at a wiring panel, while not expressly forbidden, is beyond the scope of this standard.

## 83.2 A.2 10/100Mbps, 10/100BASE-TX

When connecting your 10/100Mbps Ethernet Switch to another switch, a bridge or a hub, a straight or crossover cable is necessary. Each port of the Switch supports auto-MDI/MDI-X detection. That means you can directly connect the Switch to any Ethernet devices without making a crossover cable. The following table and diagram show the standard RJ45 receptacle/connector and their pin assignments:

RJ45 Connector pin assignment		
Contact	MDI Media Dependent Interface	MDI-X Media Dependent Interface-Cross
1	Tx + (transmit)	Rx + (receive)
2	Tx - (transmit)	Rx - (receive)
3	Rx + (receive)	Tx + (transmit)
4, 5	Not used	
6	Rx - (receive)	Tx - (transmit)
7, 8	Not used	

The standard cable, RJ45 pin assignment

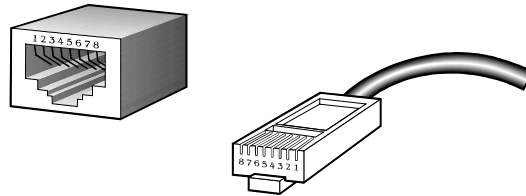

**The standard RJ45 receptacle/connector**

There are 8 wires on a standard UTP/STP cable and each wire is color-coded. The following shows the pin allocation and color of straight cable and crossover cable connection:

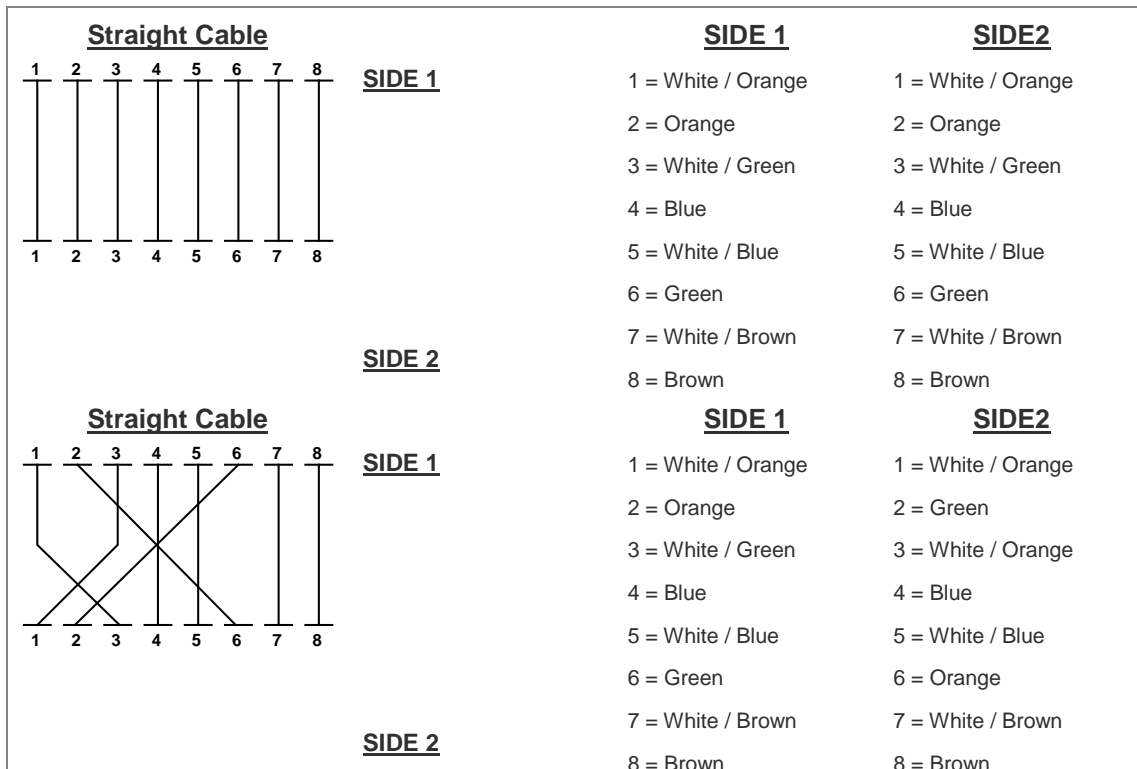

**Figure A-1: Straight-through and Crossover Cabling**

Please make sure your connected cables are with the same pin assignment and color as the above table before deploying the cables into your network.

## Chapter 84 GLOSSARY

### **Bandwidth Utilization**

The percentage of packets received over time as compared to overall bandwidth.

### **BOOTP**

Boot protocol used to load the operating system for devices connected to the network.

### **Distance Vector Multicast Routing Protocol (DVMRP)**

A distance-vector-style routing protocol used for routing multicast datagrams through the Internet. DVMRP combines many of the features of RIP with Reverse Path Broadcasting (RPB).

### **GARP VLAN Registration Protocol (GVRP)**

Defines a way for switches to exchange VLAN information in order to register necessary VLAN members on ports along the Spanning Tree so that VLANs defined in each switch can work automatically over a Spanning Tree network.

### **Generic Attribute Registration Protocol (GARP)**

GARP is a protocol that can be used by end stations and switches to register and propagate multicast group membership information in a switched environment such that multicast data frames are propagated only to those parts of a switched LAN containing registered end stations. Formerly called Group Address Registration Protocol.

### **Group Attribute Registration Protocol**

See Generic Attribute Registration Protocol.

### **Generic Multicast Registration Protocol (GMRP)**

GMRP allows network devices to register end-stations with multicast groups. GMRP requires that any participating network devices or end-stations comply with the IEEE 802.1p standard.

### **ICMP Router Discovery**

ICMP Router Discovery message is an alternative router discovery method that uses a pair of ICMP messages on multicast links. It eliminates the need to manually configure router addresses and is independent of any specific routing protocol.

### **Internet Control Message Protocol (ICMP)**

Commonly used to send echo messages (i.e., Ping) for monitoring purposes.



**IEEE 802.1D**

Specifies a general method for the operation of MAC bridges, including the Spanning Tree Protocol.

**IEEE 802.1Q**

VLAN Tagging—Defines Ethernet frame tags which carry VLAN information. It allows switches to assign end-stations to different virtual LANs, and defines a standard way for VLANs to communicate across switched networks.

**IEEE 802.3ac**

Defines frame extensions for VLAN tagging.

**Internet Group Management Protocol (IGMP)**

A protocol through which hosts can register with their local router for multicast services. If there is more than one multicast router on a given sub network, one of the routers is elected “querier” and assumes the responsibility of keeping track of group membership.

**IGMP Snooping**

Listening to IGMP Query and IGMP Report packets transferred between IP Multicast Routers and IP Multicast host groups to learn IP Multicast group members.

**In-Band Management**

Management of the network from a station attached directly to the network.

**IP Multicast Filtering**

A process whereby this switch can pass multicast traffic along to participating hosts.

**Layer 2**

Data Link layer in the ISO 7-Layer Data Communications Protocol. This is directly related to the hardware interface for network devices and passes traffic based on MAC addresses.

**Layer 3**

Network layer in the ISO 7-Layer Data Communications Protocol. This layer handles the routing functions for data moving from one open system to another.

**Link Aggregation**

See Port Trunk.

**Management Information Base (MIB)**

An acronym for Management Information Base. It is a set of database objects that contains information about a specific device.

**Multicast Switching**

A process whereby the switch filters incoming multicast frames for services no attached host has registered for, or forwards them to all ports contained within the designated multicast VLAN group.

**Open Shortest Path First (OSPF)**

OSPF is a link state routing protocol that functions better over a larger network such as the Internet, as opposed to distance vector routing protocols such as RIP. It includes features such as unlimited hop count, authentication of routing updates, and Variable Length Subnet Masks (VLSM).

**Out-of-Band Management**

Management of the network from a station not attached to the network.

**Port Mirroring**

A method whereby data on a target port is mirrored to a monitor port for troubleshooting with a logic analyzer or RMON probe. This allows data on the target port to be studied unobtrusively.

**Port Trunk**

Defines a network link aggregation and trunking method which specifies how to create a single high-speed logical link that combines several lower-speed physical links.

**Remote Monitoring (RMON)**

RMON provides comprehensive network monitoring capabilities. It eliminates the polling required in standard SNMP, and can set alarms on a variety of traffic conditions, including specific error types.

**Routing Information Protocol (RIP)**

The RIP protocol attempts to find the shortest route to another device by minimizing the distance vector, or hop count, which serves as a rough estimate of transmission cost. RIP-2 is a compatible upgrade to RIP. It adds useful capabilities for subnet routing, authentication, and multicast transmissions.

**Simple Network Management Protocol (SNMP)**

The application protocol offering network management services in the Internet suite of protocols.

**Serial Line Internet Protocol (SLIP)**

Serial Line Internet Protocol, a standard protocol for point-to-point connections using serial lines.

**Spanning Tree Protocol (STP)**

A technology that checks your network for any loops. A loop can often occur in complicated or back-up linked network systems. Spanning-tree detects and directs data along the shortest path, maximizing the performance and efficiency of the network.

**Telnet**

Defines a remote communication facility for interfacing to a terminal device over TCP/IP.

**Trivial File Transfer Protocol (TFTP)**

A TCP/IP protocol commonly used for software downloads.

**Virtual LAN (VLAN)**

A Virtual LAN is a collection of network nodes that share the same collision domain regardless of their physical location or connection point in the network. A VLAN serves as a logical workgroup with no physical barriers, allowing users to share information and resources as though located on the same LAN.

**XModem**

A protocol used to transfer files between devices. Data is grouped in 128-byte blocks and error-corrected.